

This PDF is available at <http://nap.edu/11207>

SHARE    



Sensor Systems for Biological Agent Attacks: Protecting Buildings and Military Bases (2005)

DETAILS

208 pages | 8.5 x 11 | PAPERBACK
ISBN 978-0-309-09576-1 | DOI 10.17226/11207

CONTRIBUTORS

Committee on Materials and Manufacturing Processes for Advanced Sensors; Board on Manufacturing and Engineering Design; Division on Engineering and Physical Sciences; National Research Council

SUGGESTED CITATION

National Research Council 2005. *Sensor Systems for Biological Agent Attacks: Protecting Buildings and Military Bases*. Washington, DC: The National Academies Press. <https://doi.org/10.17226/11207>.

GET THIS BOOK

FIND RELATED TITLES

Visit the National Academies Press at NAP.edu and login or register to get:

- Access to free PDF downloads of thousands of scientific reports
- 10% off the price of print titles
- Email or social media notifications of new titles related to your interests
- Special offers and discounts



Distribution, posting, or copying of this PDF is strictly prohibited without written permission of the National Academies Press. (Request Permission) Unless otherwise indicated, all materials in this PDF are copyrighted by the National Academy of Sciences.

Copyright © National Academy of Sciences. All rights reserved.

Sensor Systems for Biological Agent Attacks: Protecting Buildings and Military Bases

Committee on Materials and Manufacturing Processes for Advanced Sensors
Board on Manufacturing and Engineering Design
Division on Engineering and Physical Sciences

NATIONAL RESEARCH COUNCIL
OF THE NATIONAL ACADEMIES

THE NATIONAL ACADEMIES PRESS
Washington, D.C.
www.nap.edu

THE NATIONAL ACADEMIES PRESS 500 FIFTH STREET, N.W. WASHINGTON, DC 20001

NOTICE: The project that is the subject of this report was approved by the Governing Board of the National Research Council, whose members are drawn from the councils of the National Academy of Sciences, the National Academy of Engineering, and the Institute of Medicine. The members of the committee responsible for the report were chosen for their special competences and with regard for appropriate balance.

This study was supported by Contract No. DTRA01-00-C-0083 between the National Academy of Sciences and the Defense Threat Reduction Agency. Any opinions, findings, conclusions, or recommendations expressed in this publication are those of the author(s) and do not necessarily reflect the views of the agency that sponsored the report.

International Standard Book Number 0-309-09576-X (Book)

Available in limited supply from:
Board on Manufacturing and Engineering Design
500 Fifth St., N.W.
WS 930
Washington, DC 20001
202-334-3505
bmed@nas.edu
<http://www.national-academies.edu/bmed>

Copyright 2005 by the National Academy of Sciences. All rights reserved.

Printed in the United States of America

THE NATIONAL ACADEMIES

Advisers to the Nation on Science, Engineering, and Medicine

The **National Academy of Sciences** is a private, nonprofit, self-perpetuating society of distinguished scholars engaged in scientific and engineering research, dedicated to the furtherance of science and technology and to their use for the general welfare. Upon the authority of the charter granted to it by the Congress in 1863, the Academy has a mandate that requires it to advise the federal government on scientific and technical matters. Dr. Ralph J. Cicerone is president of the National Academy of Sciences.

The **National Academy of Engineering** was established in 1964, under the charter of the National Academy of Sciences, as a parallel organization of outstanding engineers. It is autonomous in its administration and in the selection of its members, sharing with the National Academy of Sciences the responsibility for advising the federal government. The National Academy of Engineering also sponsors engineering programs aimed at meeting national needs, encourages education and research, and recognizes the superior achievements of engineers. Dr. Wm. A. Wulf is president of the National Academy of Engineering.

The **Institute of Medicine** was established in 1970 by the National Academy of Sciences to secure the services of eminent members of appropriate professions in the examination of policy matters pertaining to the health of the public. The Institute acts under the responsibility given to the National Academy of Sciences by its congressional charter to be an adviser to the federal government and, upon its own initiative, to identify issues of medical care, research, and education. Dr. Harvey V. Fineberg is president of the Institute of Medicine.

The **National Research Council** was organized by the National Academy of Sciences in 1916 to associate the broad community of science and technology with the Academy's purposes of furthering knowledge and advising the federal government. Functioning in accordance with general policies determined by the Academy, the Council has become the principal operating agency of both the National Academy of Sciences and the National Academy of Engineering in providing services to the government, the public, and the scientific and engineering communities. The Council is administered jointly by both Academies and the Institute of Medicine. Dr. Ralph J. Cicerone and Dr. Wm. A. Wulf are chair and vice chair, respectively, of the National Research Council.

www.national-academies.org

**COMMITTEE ON MATERIALS AND MANUFACTURING PROCESSES
FOR ADVANCED SENSORS**

JOHN VITKO, JR., Sandia National Laboratories, Livermore, California, *Chair*
DAVID R. FRANZ, Midwest Research Institute, Frederick, Maryland, *Vice Chair*
MARK ALPER, University of California, Berkeley
PETER D.E. BIGGINS, Dstl Chemical and Biological Sciences, Salisbury, United Kingdom
LARRY D. BRANDT, Sandia National Laboratories, Livermore, California
CINDY BRUCKNER-LEA, Pacific Northwest National Laboratory, Richland, Washington
HARRIET A. BURGE, Harvard School of Public Health, Boston, Massachusetts
RICHARD EDIGER, PerkinElmer Analytical Instruments, Shelton, Connecticut
MARK A. HOLLIS, Lincoln Laboratory, Massachusetts Institute of Technology, Lexington
LEO L. LAUGHLIN, Battelle, Arlington, Virginia
RAYMOND P. MARIELLA, JR., Lawrence Livermore National Laboratory, Livermore, California
ANDREW R. McFARLAND, Texas A&M University, College Station
R. PAUL SCHAUDIES, Science Applications International Corporation, McLean, Virginia

Staff

JULIUS CHANG, Staff Officer (until February 2002)
SHARON YEUNG DRESSEN, Staff Officer (until May 2002)
JUDITH ESTEP, Senior Project Assistant (until April 2002)
JAMES KILLIAN, Study Director
EMILY ANN MEYER, Research Associate (until April 2004)

BOARD ON MANUFACTURING AND ENGINEERING DESIGN

PAMELA A. DREW, Boeing Phantom Works, Seattle, Washington, *Chair*
CAROL L.J. ADKINS, Sandia National Laboratories, Albuquerque, New Mexico
GREGORY AUNER, Wayne State University, Detroit, Michigan
THOMAS W. EAGAR, Massachusetts Institute of Technology, Cambridge
ROBERT F. FONTANA, JR., Hitachi Global Storage Technologies, San Jose, California
PAUL B. GERMERAAD, Aurigin Systems, Inc., Cupertino, California
RICHARD L. KEGG, Milacron, Inc., Cincinnati, Ohio
PRADEEP L. KHOSLA, Carnegie Mellon University, Pittsburgh, Pennsylvania
JAY LEE, University of Wisconsin, Milwaukee
DIANA LONG, Robert C. Byrd Center for Flexible Manufacturing, South Charleston, West Virginia
JAMES MATTICE, Universal Technology Corporation, Dayton, Ohio
MANISH MEHTA, National Center for Manufacturing Sciences, Ann Arbor, Michigan
ANGELO M. NINIVAGGI, JR., Plexus Corporation, Nampa, Idaho
JAMES B. O'DWYER, PPG Industries, Allison Park, Pennsylvania
HERSCHEL REESE, Dow Corning Corporation, Midland, Michigan
HERMAN M. REININGA, Rockwell Collins, Cedar Rapids, Iowa
LAWRENCE RHOADES, Extrude Hone Corporation, Irwin, Pennsylvania
JAMES B. RICE, JR., Massachusetts Institute of Technology, Cambridge
ALFONSO VELOSA III, Gartner Inc., Portland, Oregon
JOHN F. WHITE, Altarum, Ann Arbor, Michigan
JOEL SAMUEL YUDKEN, AFL-CIO, Washington, D.C.

Staff

TONI MARECHAUX, Director
TERI THOROWGOOD, Research Associate
LAURA TOTH, Senior Project Assistant

Preface

The past decade has seen a growing concern about the potential for biological attacks on this nation's homeland and its military facilities. This concern was dramatically underscored by the events in the fall of 2001. The attack against the World Trade Center and the Pentagon made clear terrorists' interest in mass casualties rather than smaller events to call attention to their cause. And the introduction of *B. anthracis* into the U.S. mail showed a willingness by some to use biological agents and also demonstrated their ability to develop or acquire relatively high-grade agent. When added to earlier studies that confirmed the potential of biological attacks for creating large-scale casualties, the events of the fall of 2001 added both a new sense of realism and urgency regarding such threats.

Fortunately, during the past decade the nation had also invested significantly in developing technology to detect and respond to such a biological attack. As a result of this investment, it is now possible to detect and identify biological agents in time (tens of minutes to hours) to pretreat potential victims before the onset of symptoms, thereby greatly reducing the consequences of most attacks. However, these time scales are still too long to enable the occupants of a facility to take some action to minimize their exposure—for example, by altering airflow in a facility, sheltering in place, or evacuating the facility.

Realizing the attractiveness of certain facilities as targets of biological attack and the desirability of minimizing the effects of any such attack not just by early treatment of exposed personnel but also by detection in time to minimize such exposures, the Defense Threat Reduction Agency (DTRA) chartered a study to examine the path to "detect to warn" sensors for facility protection. Specifically, DTRA asked that the study examine representative scenarios for facility protection, elucidate the driving sensor requirements, identify detection technologies and systems that have the potential for meeting those requirements, and chart a roadmap for attaining those capabilities.

To address these tasks the National Research Council formed a committee comprising experts in systems studies, sampling, detection technologies, microbiology, aerosol backgrounds, materials technologies, and instrument development and commercialization. The Committee on Materials and Manufacturing Processes for Advanced Sensors, in turn, called on experts at the Department of Defense (DoD), the Defense Advanced Research Projects Agency (DARPA), the Department of Energy (DOE), and in the university and industry sectors to understand the issues associated with detect-to-warn for facility protection and the status and prospects for a broad range of advanced detection and identification systems. The committee examined all the major families of detection systems from simple aerosol detectors, to those that identify an agent based on its genetic, structural, or chemical properties, to so-called "functional sensors," which detect the response of cells and organisms to the presence of an agent.

After approximately 1 year of briefings, study, evaluation, synthesis, and integration the committee arrived at a roadmap that it believes establishes an important but limited detect-to-warn capability in the near term and charts the path to a robust detect-to-warn capability in the next 5 to 7 years. This roadmap and the supporting analyses are given in the following report.

This report has been reviewed in draft form by individuals chosen for their diverse perspectives and technical expertise in accordance with procedures approved by the National Research Council's (NRC's) Report Review Committee. The purpose of this independent review is to provide candid and critical comments that will assist the institution in making its published report as sound as possible and to ensure that the report meets institutional standards for objectivity, evidence, and responsiveness to the study charge. The review comments and draft manuscript remain confidential to protect the integrity of the deliberative process. We wish to thank the following individuals for their review of this report:

Leonidas Bachas, University of Kentucky,
John Brockman, Sandia National Laboratories,
C.W. Chu, Texas Center for Superconductivity,
Catherine Fenselau, University of Maryland,
Robert Hawley, U.S. Army Medical Research Institute of Infectious Diseases,
Mohamed Sofi Ibrahim, U.S. Army Medical Research Institute of Infectious Diseases,
John MacChesney, Bell Laboratories, Lucent Technologies,
Timothy Moshier, SPARTA, Inc.,
Gary Resnick, Los Alamos National Laboratory, and
Ashley Williamson, Southern Research Institute.

Although the reviewers listed above have provided many constructive comments and suggestions, they were not asked to endorse the conclusions or recommendations nor did they see the final draft of the report before its release. The review of this report was overseen by Royce Murray of the University of North Carolina, Chapel Hill. Appointed by the National Research Council, he was responsible for making certain that an independent examination of this report was carried out in accordance with institutional procedures and that all review comments were carefully considered. Responsibility for the final content of this report rests entirely with the authoring committee and the institution.

The committee greatly appreciates the support and assistance of National Research Council staff members James Killian, Emily Ann Meyer, Julius Chang, and Sharon Dressen, and of Greg Eyring, who consulted in many stages of this study, including in its writing.

John Vitko, Jr., *Chair*
Committee on Materials and Manufacturing
Processes for Advanced Sensors

Contents

EXECUTIVE SUMMARY	1
1 BACKGROUND AND OVERVIEW	7
Statement of Task, 7	
Scope and Committee Approach, 9	
Concluding Thoughts, 12	
2 SCENARIOS, DEFENSIVE CONCEPTS, AND DETECTION ARCHITECTURES	13
Scenario Selection and Defensive Concepts, 14	
Outdoor Release Scenarios, 14	
Facility Release Scenarios, 15	
Military Versus Civilian Scenarios, 15	
Defensive Concepts Against Attacks on Facilities, 16	
Defensive Concepts Against Attacks on Distributed Target Complexes, 17	
Key Detection System Attributes and Trade-offs, 18	
Detector Performance Attributes in Detect-to-Warn Scenarios, 18	
Detection System Trade-offs, 19	
Key Architectural Design Principles for Detection, 19	
Multistage Detection Architectures, 20	
Detect-to-Warn Architecture Performance, 22	
3 INDOOR AND OUTDOOR BIOAEROSOL BACKGROUNDS AND SAMPLING STRATEGIES	23
Organisms and Particles, 23	
Analytical Methods, 25	
Sources of Bioaerosols, 27	
Outdoor Pollen, 27	
Outdoor Fungi, 29	
Outdoor Bacteria, 31	
Other Outdoor Bioaerosols, 32	
Indoor Aerosols, 33	
Indoor Pollen and Pollen-Derived Particles, 35	
Indoor Fungi, 35	
Indoor Bacteria, 36	
Predicting the Prevalence of Bioaerosols, 39	

	Control of Bioaerosols, 41	
	Air Cleaning, 41	
	Air Treatment, 42	
	Findings and Recommendations, 43	
	Outdoor Aerosols, 43	
	Indoor Aerosols, 44	
	Predictive Models, 44	
	Sampling Strategies to Obtain Critical Missing Data, 45	
4	BIOAEROSOL SAMPLINGS SYSTEMS FOR NEAR-REAL-TIME DETECTION	46
	Particle Size Considerations, 47	
	Sampling from the Ambient Environment, 47	
	Sampling from Occupied Environments, 48	
	Bioaerosol Sampling from Indoor Air, 48	
	Sampling from Building Ductwork, 49	
	Collector Technology, 56	
	Sampling from Occupied Environments, 59	
	Sampling Bioaerosols from Ambient Air, 61	
	Aerosol Concentrators, 62	
	Performance of Virtual Impactor Aerosol Concentrators, 63	
	Performance of Cyclonic Concentrators, 64	
	Novel Concentrators, 64	
	Ideal Power to Draw Air Through a Concentrator, 65	
	Power Consumption to Prevent Freezing of Liquid, 66	
	Aerosol-to-Hydrosol Transfer Stages, 66	
	Findings and Recommendations, 68	
	Ductwork Sampling, 68	
	Occupied Area Sampling, 69	
	Ambient Sampling, 69	
5	POINT AND STANDOFF DETECTION TECHNOLOGIES	71
	Point Detection Technologies, 72	
	Current Instrumentation, 73	
	Point Detection Summary, 74	
	Standoff Detection Technologies, 75	
	Ultraviolet Systems, 77	
	Standoff Detection Summary, 78	
	Novel or Advanced Standoff Detection Techniques, 79	
	Ultraviolet Resonance Raman Spectroscopy, 79	
	Other Ultraviolet Systems, 81	
	Terahertz Spectroscopy, 81	
	Findings and Recommendations, 81	
	Spectroscopic Point Detectors, 81	
	Standoff Detectors, 82	
6	NUCLEIC ACID SEQUENCE-BASED IDENTIFICATION FOR DETECT-TO-WARN APPLICATIONS	84
	Sample Collection, 85	
	Sample Preparation, 85	
	Nucleic Acid Assays, 89	
	Group I: Assays That Use Amplification Techniques, 90	
	Group II: Sequence-Based Assays That Do Not Use Amplification Techniques, 99	
	Detection, Identification, Analysis, and Reporting, 101	
	Strawman Concept for a Fast RNA Detection/Identification System, 102	
	Findings and Recommendations, 103	

7	STRUCTURE-BASED IDENTIFICATION FOR DETECT-TO-WARN APPLICATIONS	105
	The Structure-Based Biosensor: Basic Elements, 108	
	Sample Collection, 108	
	Sample Concentration, 108	
	Binding of Target to the Molecular Recognition Element, 109	
	Specific Detection and False Alarms, 110	
	Addition and Removal of Reporter Groups, 113	
	Detection of Target Molecular Recognition Element Complex, 113	
	Renewal of the Sensor Surface for Continuous Monitoring, 114	
	Consumables Considerations for Detect-to-Warn Applications, 114	
	Notional Structure-Based Detection Systems, 115	
	Detailed Considerations: Molecular Recognition Elements, 116	
	Antibodies, 116	
	Aptamers, 117	
	Peptides, 118	
	Small Molecules, 119	
	Protein Receptors and Other Cell Surface Features, 119	
	Imprinted Polymers, 120	
	Detailed Considerations: Notional Detection Systems, 120	
	Immunoassay Tickets, 120	
	Direct Binding Assays, 121	
	Surface Plasmon Resonance, 121	
	Flow Cytometry, 122	
	Target Binding That Changes Detectable Properties of Smart Sensor Surfaces, 124	
	Colorimetric Detection, 124	
	Fluorescence Detection, 125	
	One-Step Signal Amplification Concepts, 125	
	Modified Cell-Based Systems, 126	
	Waveguides and Fluorescent Detection, 127	
	Findings and Recommendations, 128	
8	CHEMISTRY-BASED IDENTIFICATION FOR DETECT-TO-WARN APPLICATIONS	130
	Mass Spectrometry, 131	
	Challenges for Rapid, Simple-to-Use Mass Spectrometry Identification Systems, 135	
	Gas- and Liquid-Phase Separations for Pathogen Detection, 137	
	Chemical Sensors, 138	
	Dipicolinic Acid Analysis, 142	
	Direct Labeling of Pathogens for Detection, 144	
	Flow Cytometry, 144	
	Planar Sensors, 144	
	Vapor Analysis of Cell Metabolites, 146	
	Microscale Monitoring of Cell Metabolites, 146	
	Findings and Recommendations, 147	
9	FUNCTION-BASED DETECTION	149
	Cell-Based Response Systems, 151	
	Research Issues, 153	
	Interfacing with Sampling Systems, 153	
	Operational Deployment, 153	
	Conclusion, 153	
	Findings and Recommendations, 153	
10	DESIGN CONSIDERATIONS FOR DETECT-TO-WARN DEFENSIVE ARCHITECTURES	155
	Systems Aspects of Defensive Architectural Design, 155	
	Key Principles for Detection System Design, 156	
	Facility Protection Architectures, 157	

	Time Line and Zone Isolation Considerations, 158	
	Example: Attack on a Multizone Office Building, 159	
	Impact of Facility Design on Defensive System Effectiveness, 163	
	Other Facility Detection System Considerations, 166	
	Facility Protection—Strategies and Priorities, 167	
	Distributed Target Defensive Architectures, 168	
	Detection Architecture Options, 169	
	Example: Attack on an Extended Military Installation, 169	
	Distributed Target Protection—Strategies and Priorities, 173	
	Findings and Recommendations, 174	
	Defense of Facilities, 175	
	Defense of Distributed Military Installations, 176	
	General Recommendations, 176	
11	SUMMARY OF CONCLUSIONS AND A PATH FORWARD	178
	Detection and Identification Systems, 178	
	Nonspecific Detectors, 178	
	Specific Detection and Identification Technologies, 179	
	Detect-to-Warn Systems for Buildings and Extended Military Installations, 182	
	Protection of Buildings, 183	
	Protection of Military Installations, 184	
	Top-Level Technical Findings and Recommendations, 185	
	Most Probable Path, 185	
	Technology Watch List, 186	
	APPENDIXES	187
A	Biographical Sketches of Committee Members	189
B	Acronyms and Abbreviations	194

Executive Summary

Concerns are increasing about the possibility of bioterrorism against U.S. civilian and military facilities and personnel. Early detection and warning will play a significant role in minimizing the consequences of such attacks. Today, it is possible to detect and identify biological agents in time to pretreat victims before the onset of symptoms. In the future, increased emphasis will be placed on the ability to "detect-to-warn" (the detection of an agent cloud in time to alter air movement within a building; the ability to treat the air before it reaches the occupants; or the ability of personnel to protect themselves from exposure with physical barriers to the hazards).

Analyses of representative scenarios of biological attacks indicate that if one desires to detect the agent cloud in time to warn personnel who are at risk, it is necessary to complete the sample collection, preparation, analysis, and initiation of protective measures in less than 3 to 5 minutes, and preferably in about 1 minute. This time line is extremely challenging for technologies that are available today.

ORGANIZATION OF THE STUDY

Two scenarios of biological agent attack are considered: an indoor release against the population of a building and an outdoor release against an extended military installation. Many aspects of the ability to detect-to-warn are important for these two scenarios, including time lines; defensive concepts including passive as well as active protective measures; and the trade-offs among detection times, sensitivities, and false alarm rates. Detection architectures and systems that could be deployed by 2010 are a particular focus.

Because a detection system depends critically on how samples are collected and prepared, sampling strategies (where and how many) and the current status of collector and concentrator technologies are critical. Attainable detection levels and false alarm rates are also strongly influenced by the nature and variability of naturally occurring outdoor and indoor aerosols. The role that rapid, nonspecific standoff and spectroscopic point detectors might play must be considered along with the role of more specific technologies that offer a means of identifying biological agents used in an attack.

The four main categories of identification technologies are nucleic acid sequence-based methods; structural (antibody or artificial ligand capture and identification) methods; chemical (molecular or composition-sensitive) methods; and functional methods (based on the sensitivity of living cells, organs, or organisms). In each case, two key questions are important:

- What level of detection (sensitivity and false alarm rate) can one hope to attain by 2010 given

- about 1 minute for detection; and
- What is the shortest detection time one can hope to attain by 2010 if one insists on maintaining performance at a level comparable to that currently achieved in the 30-minute time frame?

Based on the committee's assessment of state-of-the-art technology, various detection architectures must be considered—that is, combinations of detectors to provide improved confidence of detection; protective responses appropriate to the various confidence levels; and alternative ways of distributing the detection systems within a building or base.

A PHASED IMPLEMENTATION STRATEGY

Before the anthrax attacks of 2001, many scientists were highly skeptical that effective detect-to-warn systems could be deployed by 2010. Today, there appears to be a growing consensus that detection systems that provide warning for a significant portion of the threat space could be deployed for high-value buildings and probably even for military bases. However, it is impossible to quantify the probability of the effectiveness of such systems against real terrorist attacks because this would depend on specific attack scenarios, specific sensor architectures, and the robustness of the concept of operations.

Major conclusions regarding the feasibility of detect-to-warn capabilities in both the indoor and outdoor release scenarios are outlined below. These conclusions lead to a proposed phased implementation strategy for each scenario by which some protective steps can be taken in the next few years while more capable systems are being developed.

Each of the phases includes the following elements: passive improvements to the physical security and air handling systems of the facility, a detection system (including a collector/concentrator if needed), an information management system to relay the data to the facility manager, and appropriate building responses, ranging from turning off the heating, ventilating, and air conditioning (HVAC) system to facility evacuation. With the exception of the detection systems, most of the other elements are within the current state of practice for modern facilities and are not discussed further here.

Protection of Buildings

In the confined spaces of buildings, even small releases of biological agents can result in very high local concentrations in a typical air handling zone. For these scenarios, relatively simple and rapid nonspecific bioaerosol particle detection systems may provide a baseline facility detect-to-warn capability in the next 1 to 2 years (Figure ES.1). Such a system would have the advantage of being independent of the detailed nature of the agent and hence would provide broad-spectrum coverage, but without specificity. Importantly, even though the bioaerosol concentrations are high in the vicinity of the detector—making detection feasible—subsequent transport losses and filtration will reduce these concentrations by several orders of magnitude prior to the circulation of contaminated air to adjacent rooms or air handling zones.

Over the next 5 years, one can increase the capabilities of this system so as to detect even lower levels of attack (Figure ES.2). At these more sensitive detection thresholds, however, a bioaerosol detector will be increasingly prone to false alarms. In this case, the addition of another detector that can rapidly identify specific agents and hence discriminate them from ambient backgrounds becomes important.

Of all the identification technologies, structure-based detection (e.g., immunoassays) appears to offer the greatest potential for identification in two minutes or less with very low false alarm rates. Nucleic acid sequence-based assays such as those involving polymerase chain reaction (PCR) technology could then provide definitive confirmation of an attack and of the species of the biological agent.

The different strengths and weaknesses of these various kinds of sensors lead naturally to the concept of a system of detectors: a bioaerosol detector that can detect all bioagents (known and

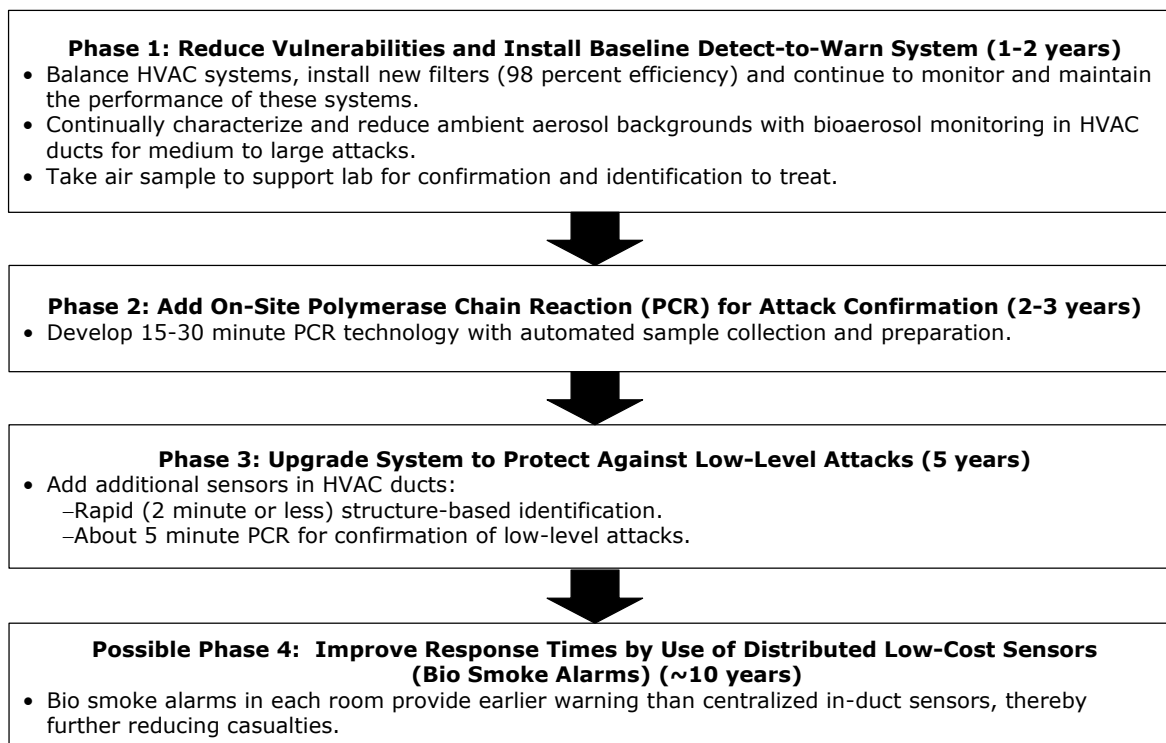

FIGURE ES.1 Suggested phased strategy for protection of high-value buildings from an aerosolized biological agent.

unknown) with low false alarm levels for modest to large-size attacks, backed up by a rapid, structure-based identifier that can detect very small attacks—all on the order of 1 to 2 minutes. Ideally, both the bioaerosol detector and the rapid identifier would be operating continuously, making measurements every 1 to 2 minutes. When either or both devices alarm at a high signal-to-noise level, high-regret responses such as sheltering in place or evacuating the building would be initiated. If the detection or identification signal is of a lower signal-to-noise level, then low-regret options such as HVAC shutoff or air sterilization would be initiated. In all alarm cases, an air sample would be collected and passed to a sequence-based analyzer for confirmatory analyses on a 15-minute time scale.

Because of the costs of the associated detectors, the above concept leads naturally to a centralized detection architecture in which a detection system comprising a suite of detectors is placed in—or takes samples from—the HVAC system of each air handling zone in a facility. The fact that the agent concentration level can be higher in a given room or region near the release point than in the air handling unit also raises the intriguing possibility of a distributed detection system, composed of less capable but less expensive detectors. Additional systems analysis as well as research and development on such low-cost sensors is needed to better evaluate the potential of this option.

Protection of Extended Military Installations

The concept of using a nonspecific detector for biological agent attacks backed up by a rapid identifier can also be applied to a perimeter monitoring system to detect outdoor attacks on military bases. The agent concentrations will likely be lower in an outdoor attack than in an interior release in confined spaces—how much lower depends on whether the attack is aimed only at personnel who are outdoors or if it is also aimed at personnel within buildings, in which case it must be sized to overcome the passive building defenses (e.g., dilution and filtering). Also, the outdoor ambient background is

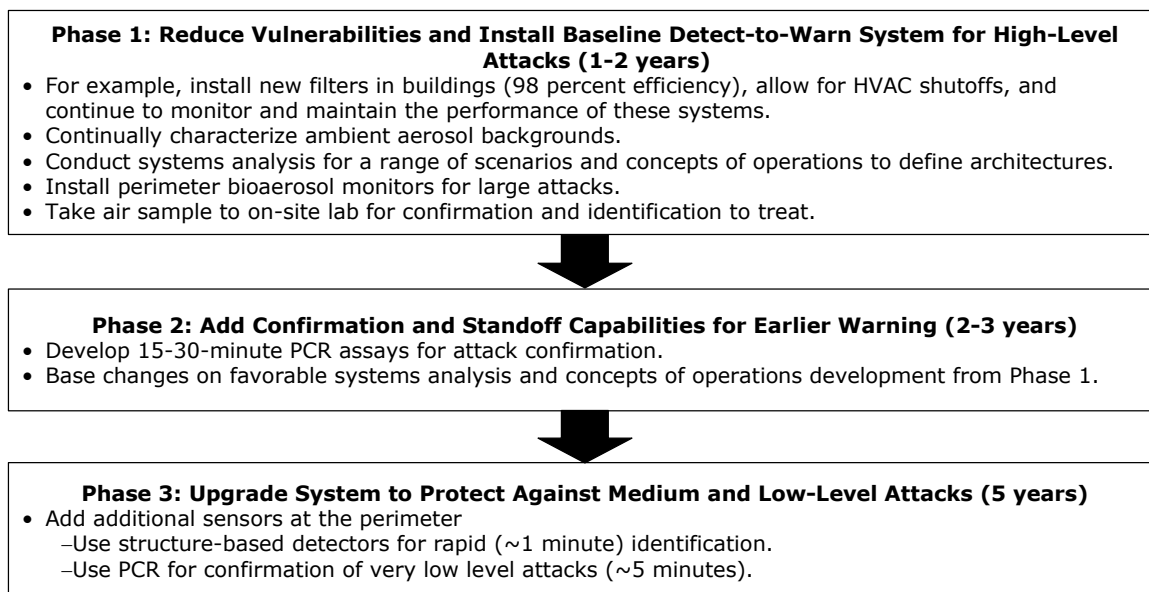

FIGURE ES.2 Suggested phased strategy for protection of extended military installations from an aerosolized biological agent.

generally—but not always—expected to be higher and to fluctuate more than the ambient background in a filtered building. This will tend to produce a higher rate of false alarms with nonspecific detectors.

The combination of the lower agent concentration levels and the higher backgrounds associated with an outdoor release means that an array of nonspecific, spectroscopic point detectors at the base perimeter will cover a smaller portion of the threat space than it would in the building defense architectures. It may be that a standoff detection system using a combination of IR and ultraviolet lasers to interrogate an incoming bioaerosol cloud from a distance of several kilometers could address this deficiency. However, suitable concepts of operations for standoff detectors have yet to be developed.

In an outdoor release scenario, many of the potential agents can be treated with postexposure prophylaxis, presumably initiated by detect-to-treat systems, which can often provide effective alternatives to a detect-to-warn system. Collective protection systems can also provide safe interior zones to maintain critical functions. While detect-to-treat systems will likely be the foundation of installation defense against outdoor releases in the near term, the employment of Phase 1 concepts may enable detect-to-warn capability for larger outdoor and multifacility attacks. This could add value in several areas, including the following:

- Even partially effective detect-to-warn systems can enable response options that might avoid or reduce exposure to organisms engineered for antibiotic resistance or for other agents (e.g., toxins) for which no prophylaxis exists.
- Initial detect-to-warn systems will provide options for that portion of the population that is contraindicated for prophylaxis.
- Some detect-to-treat warning may enable protective responses even in areas (particularly interior spaces) in which more complete collective protection measures are not implemented. This could provide partial, but much less costly, defense of a much larger population.
- A nonspecific detection component will provide some capability against those agents not included in the few to tens of pathogens addressed by specific detect-to-treat assays.

If Phase 1 is skipped, the first detect-to-warn capability will be delayed for at least 5 years until rapid

identifiers become available. In this scenario, it appears that more of the warning burden will fall on the rapid identifiers, which are about 5 years away. Fortunately, the rapid identifier need not be quite as rapid as for building protection. For typical wind speeds of 5 meters per second, each kilometer of standoff distance of the detector from the actual target area to be protected results in an additional 3 minutes to take action.

TECHNICAL FINDINGS AND RECOMMENDATIONS

The phased implementation strategies suggested above reflect one path forward that is judged to be most likely to lead to success. However, technologies that appear less applicable today may experience breakthroughs in the future, and totally unforeseen technologies may emerge. Thus, it is prudent to group technical findings and recommendations into two categories: the most probable path and a technology watch list. The most probable path consists of those technologies whose currently demonstrated capabilities provide the basis for a reasonably well understood path to desired sensor system capabilities. The technology watch list consists of promising technologies that have yet to demonstrate one or more critical features before use in detect-to-warn applications. If these breakthroughs are achieved, however, the technologies on the watch list could become very attractive.

Most Probable Path

The committee finds that protection of buildings and military installations from biological attack requires the careful integration of detection capabilities with response options and procedures. **Therefore, the committee recommends that military planners take a systems approach to facilities protection.**

The committee finds that a successful detect-to-warn system requires that the local bioaerosol background be well understood. **Therefore, the committee recommends that local aerosol backgrounds and their sources be characterized using the same methods that detectors would use.** Within buildings where detectors are to be placed, steps should be taken to reduce these backgrounds.

The committee finds that the greatest disadvantage of using rapid, nonspecific detectors such as bioaerosol detectors is their potentially high false alarm rate at very low levels of detection. **Therefore, the committee recommends that the false alarm rate of bioaerosol detectors be characterized in relevant facility environments as a function of detection threshold.** Research should be supported on additional spectral and physical signatures and improved algorithms and techniques to further decrease the false positive rates.

The committee finds that structure-based assays appear to have the greatest potential for identifying biological agents with the speed, sensitivity, and specificity required for detect-to-warn applications. **Therefore, the committee recommends that research be supported that would lead to an improved structure-based detector.** The goal of this program should be a system with very low false alarm rates and a 2-minute or less overall detection time.

Although a detect-to-warn system has its highest impact if it can initiate responses within approximately 1 minute of an attack, even response times on the order of 5 to 15 minutes can be useful. The committee finds that technologies that provide confirmation of the attack and identify the organisms involved will serve a vital function in the overall defensive architecture. **Therefore, the committee recommends that research be continued on the development of an integrated, fully automated PCR system, including sample collection, preparation, and analysis.**

The committee finds that while prototype instruments for standoff detection of biological agents have been developed and tested, there is no currently fielded capability for such standoff detection, nor is there a clear concept of operations for the use of such systems. **Therefore, the committee recommends that a clear concept of operations be developed for standoff detection in support of base protection and, if appropriate, that the development of a hybrid infrared/ultraviolet laser-induced fluorescence system be expedited for these applications.**

Technology Watch List

The committee finds that mass spectrometry has the potential to identify biological agents based on a biofingerprint matching method and has the potential to do so with limited reagent consumption.

Therefore, the committee recommends that the use of laboratory mass spectrometry be investigated to better understand the performance of biofingerprinting in complex mixtures of naturally occurring microorganisms and other background contaminants. This should be done with parallel development of improved sample preparation methods.

The committee finds that the biological smoke alarm concept offers intriguing potential for rapid detection. This concept uses networked, low-cost, semiselective detectors distributed throughout the rooms in a building. **Therefore, the committee recommends that research be conducted to develop and characterize the performance of low-cost arrays of semiselective sensors that can be used as a biological smoke alarm for triggering low-regret response measures.**

The committee finds that ribosomal RNA assays might be capable of biothreat agent identification in one to several minutes. This approach, with a major development effort, could avoid the time-consuming amplification cycles of many nucleic acid sequencing assays. **Therefore, the committee recommends that the potential and the limitations of rRNA detection for rapid identification of pathogens be explored.**

The committee finds that function-based sensors are one of the few promising candidates for detecting unknown hazardous agents—that is, agents that had not been anticipated. Their response time is inherently tied to the time it takes an agent to have a physiological effect on sentinel organisms or tissues. For certain chemical agents and toxins, this effect can be very rapid, but for bacteria and viruses, it can take much longer. These longer response times for bacteria and viruses make it unlikely that function-based sensors will play a significant role in detect-to-warn applications for these agents, but they could nevertheless play a valuable detect-to-treat role in the overall biodetection architecture. **Therefore, the committee recommends that studies be conducted to better understand the role of function-based sensors in overall biodetection architectures and to provide goals to focus research and development activities on those areas for which function-based sensors have the highest leverage.**

CONCLUSIONS

Detection systems that could provide rapid warning for a significant portion of the threat space could be deployed by 2010 to high-value buildings and probably even to military bases. The development and deployment of these systems can significantly reduce the number of casualties associated with a biological attack. Typical requirements are for detection of a broad spectrum of agents in a time approaching 1 minute (including sample collection and preparation) with a very low false alarm rate (about one false alarm per million sampled, corresponding to approximately one false alarm per year). The most promising approach for attaining this uses a combination of advanced detectors: for example, a nonspecific detector capable of detecting any and all biological agents and suitable for defense against medium to large attacks; a rapid, structure-based identifier capable of identifying 10 to 20 of the leading threat agents and suitable for discriminating a low-level attack from the natural background; and an autonomous PCR capability for rapid confirmation of an attack.

The independent use of three different detection techniques results in a very low false alarm rate and a high level of robustness against potential countermeasures. Critical crosscutting needs include rapid and autonomous sample preparation and better characterization of ambient bioaerosol backgrounds and sources, as well as ways to reduce these backgrounds in current and future buildings.

Finally, it should be noted that preventive and passive defenses (including measures such as improved security and threat assessment, as well as improved filtering and balancing of HVAC systems) play a significant role in reducing exposures and in raising the minimum attack level needed to produce significant casualties, thereby making it easier to detect biological agents and to initiate protective responses.

1

Background and Overview

Despite the existence of the Biological Weapons Convention,¹ the U.S. Department of State estimates that more than a dozen countries are pursuing the development of biological weapons.² Of perhaps greater concern is the possibility that domestic or international terrorist groups could acquire or create biological weapons and use them against unprotected civilian or military targets. The anthrax letter attacks in 2001, in which the dissemination of a few grams of *Bacillus anthracis* spores in mailed envelopes resulted in the infection of 23 Americans and the death of 5, heightened Americans' sense of vulnerability—particularly coming as they did less than a month after the overwhelming attacks on the World Trade Center, in which nearly 3,000 people lost their lives.

In future events involving biological agents, early detection of an infectious agent cloud and early identification of individuals exposed will help to save lives. As shown in Figure 1.1, the earlier one can detect the release of a biological agent, the greater the options available for response. Thus, one speaks of detect-to-warn for the few minutes after an agent is dispersed during which it is still possible to take some action to minimize exposure. Similarly, one speaks of detect-to-treat for those hours or days following the release of agent when detection can still lead to early medical treatment and improved prognosis. At longer times, the benefits of detection are limited to assessment of the level of contamination and forensic identification of the source of the agent.

Today, technology can support the detection and identification of biological agents in time to pretreat patients before the onset of symptoms. In the future, greater emphasis will be placed on detect-to-warn—that is, the detection of an agent cloud in time to alter air movement within a building, treat the air before it reaches the occupants, or allow personnel to protect themselves with physical barriers to the hazards.

STATEMENT OF TASK

The Defense Threat Reduction Agency (DTRA) was created with the mission of reducing threats to the United States and its allies from nuclear, biological, chemical, conventional, and special weapons. Government policy makers, including DTRA, have identified rapid detection of attacks with biological

¹ The Biological Weapons Convention, signed by over 160 countries, including the United States, entered into force on March 26, 1975. It prohibits the development, production, and stockpiling of biological and toxin weapons but contains no enforcement mechanism.

² Remarks of John R. Bolton, Under Secretary of State for Arms Control and International Security, at the Tokyo America Center, Tokyo, Japan, August 26, 2002.

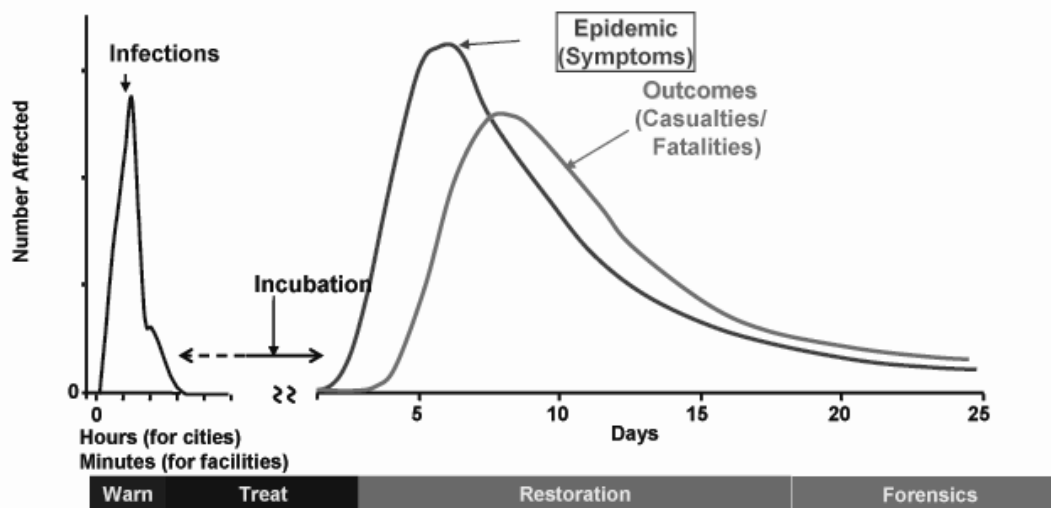

FIGURE 1.1 Notional time line for an anthrax attack showing the different detection regimes and requirements corresponding to different portions of the biological event. Detect-to-warn systems must respond in sufficient time to allow protective measures to prevent or minimize exposure of a significant portion of the at-risk population. Thus, detect-to-warn time lines can be on the order of hours for cities but only a few minutes or less for facilities.

agents as a priority, including the deployment of unobtrusive detect-to-warn sensor systems in key locations such as subways, airports, arenas, and military and government installations.

Accordingly, DTRA gave the committee four tasks:

1. Review the DTRA-specified requirements³ for detect-to-warn systems. Identify those requirements that will especially drive the detection concepts and architectures—for example, less than 1 minute detection times and continuous operations, with attendant implications for consumables and their costs—and understand to what extent, if any, these or related parameters, such as detection sensitivities, may be relaxed.
2. Consider examples of representative operational scenarios or architectures (to be provided by DTRA), which will be invaluable in putting these system requirements and trade-offs in context.
3. Identify specific sensor and sampling technologies that have the potential to satisfy system requirements, assess their state of development, and prepare a roadmap for further development to demonstrate required performance. If necessary, suggest temporary modifications to system specifications for interim development by FY2010 and fielding of best available technologies.
4. To the extent that the maturity of the above sensor and sampling technologies allows, identify critical materials, manufacturing technologies, and system design issues required to fabricate, validate, deploy, and support these sensor systems in diverse environments and enable the systems to meet requirements for low false alarm rates, low cost, compact size, light weight, low maintenance, and low power. The committee will also assess the current state of development of key enabling technologies and identify strategies and associated time lines for addressing major deficiencies.

³ The principal requirements are a 1-minute or less response time, capacity for continuous operation, high sensitivity, low false alarm rate, low cost, and maintainability. There are often trade-offs to be made among these requirements/characteristics.

For Task 2, the committee was given two basic scenarios of attack to consider: (1) the release of biological agent within a building or occupied space and (2) an outdoor release targeting an extended military installation.

SCOPE AND COMMITTEE APPROACH

The technologies for detection of biological agents considered by this committee are capable of providing different levels of information and may operate on different time scales. The functions performed by these technologies fall into three general categories:

- Detection of the presence of biological particles (living or dead, pathogenic or nonpathogenic) in ambient air. Such detectors, which can provide a rapid response but may not be able to distinguish between hazardous agents and the nonhazardous biological background, are termed "nonspecific."
- Tentative identification of specific biological agents or forms based on genetic, structural, chemical, or functional characteristics. Such detectors are likely to have a somewhat slower response than nonspecific detectors and must be preprogrammed to respond to anticipated biological threats.
- Confirmation of the presence of specific types of biological agents. These technologies typically use multiple signatures for a more definitive identification of the species of agent but are likely to have the slowest response times.

To be useful, a detect-to-warn sensor system must be carefully integrated with the response capability. The response triggered by the sensor system—and the magnitude of the potential regret level (i.e., in case of a false alarm)—must be commensurate with the sensitivity and the false alarm rate. The ultimate goal is to keep a respirable aerosol out of the breathing space of humans who are at risk. A graded response for an indoor release scenario might first include a rapid, automatic reconfiguration of the HVAC system (which could be made imperceptible to the building occupants). Then, with more specific information about a biological attack might come a warning to don a protective mask or gear. Finally, a building or parts of a building complex might be evacuated. Too great a response to frequent false alarms will be too disruptive of normal human function and will likely result in the warning system being removed or ignored.

The value of the information provided by the sensor system will relate directly to the sensitivity, specificity, and false alarm rate of the assay system. Thus, the committee considered a variety of such characteristics as outlined in Box 1.1. Does the system sample enough air to find the threat organisms if they are present? Does it identify specific pathogens or simply detect an increase of respirable particles in the air?

To be of value, definitive information must be available in minutes to enable physical protective responses; hence DTRA's request for study of a one-minute warning sensor. In its deliberations, the committee focused on sensor technologies that could offer a one-minute response, although in some cases it considered detectors that could respond in 2 minutes or less since these could help save lives in some scenarios, even though this longer response time is less than optimal for many detect-to-warn applications. Depending on the type of sensor/detector system, the following sequence of processes might be required within this response time:

- Collection of the sample,
- Preparation of the sample for analysis,
- Performance of the assay itself, and
- Analysis and reporting of the results of the assay.

Box 1.1 Characteristics of Biosensors

Specificity	The sensor must report the presence of the particular target(s) it has been assigned and, to the extent possible, no others.
Sensitivity	The sensor must be able to detect very low levels of the target.
Speed	The sensor must report quickly.
Cost	Depending on the number to be deployed and the extent of the threat and consequences of failure to detect target, cost of manufacture and maintenance must be kept to a minimum.
Reliability	Depending on the capability and cost of maintenance, the sensor must maintain function, often in harsh environments, over extended periods of time and without significant maintenance.
Ease of manufacturing	The sensor must be easy to manufacture.
Size and weight	Light weight and small size can be important in certain applications.
Power and consumable requirements	Remote applications, for example, may require low power and few consumables.
Ability to work in complex mixtures	In many applications, samples may contain a wide variety and amount of living and nonliving "contaminants," which may or may not be easily removed before testing but which may not be allowed to interfere with the detection of the designated target.
Low false positive rate	Frequent false alarms, even in systems that have no false negatives, can be unacceptable; simultaneous examination of independent epitopes can help limit this.
Multianalyte detection	Uncertainty about the specific nature of the threat can require that a given sensor respond to many targets and, preferably, identify which one has triggered the alarm, either by "lighting up" the one signal associated with that target or by exciting a recognizable pattern of outputs from a set of signals.
Continuous / batch sensing	An ideal system would be able to monitor continuously, although repeated batch analysis could, if necessary, meet certain system requirements.
Ease of operation	Widespread use of large numbers of sensors could demand automated operation or use by operators with minimal training. Little or no required preprocessing of sample is advantageous.
Detection of live vs. dead organisms	Sensors for pathogenic organisms would be more effective if able to determine live vs. dead organisms in a mixture.

Cost will be an issue, and some sensor systems will require more logistical support than others. Other cost-related considerations include the following: Will there be dual-use applications that might help justify the cost, or will the sensors only be of value for protection from bioterrorism? Will other countermeasures—for example, full-time air filtration systems or simply increased physical security—be more cost-effective than sensor systems?

This report considers the biological threat from intact agents such as bacteria and viruses (including genetically engineered or mutated agents) as well as from the molecular toxins produced by such organisms. A prioritized list of biological threat agents developed by the Centers for Disease Control and Prevention is shown in Table 1.1. The route of exposure considered in this report is assumed to be inhalation of aerosolized agents rather than skin exposure, contamination of food or water, or vector-borne transmission, because aerosols are likely to be the quickest and most effective means of exposing large numbers of people in the attack scenarios considered.

Aerosol particles between 1 and 10 micrometers are generally considered to be the most efficient for respiration into the human lung; however, the committee considered aerosols with particles as large as 30 micrometers because these larger particles can remain suspended in air for considerable times and are still reasonably effective in causing infection. Moreover, these larger particles are likely to be present in terrorist attacks that may rely on less sophisticated aerosolization methods.

TABLE 1.1 Centers for Disease Control and Prevention (CDC) Prioritized List of Biological Threat Agents^a

Disease (Organism)	Agent Type ^b
Category A^c	
Anthrax (<i>Bacillus anthracis</i>)	B
Botulism (<i>Clostridium botulinum</i> toxin)	T
Plague (<i>Yersinia pestis</i>)	B
Smallpox (<i>variola major</i>)	V
Tularemia (<i>Francisella tularensis</i>)	B
Viral hemorrhagic fevers (filoviruses—e.g., Ebola and Marburg—and arenaviruses—e.g., Lassa and Machupo)	V
Category B^d	
Brucellosis (<i>Brucella</i> species)	B
Epsilon toxin (from <i>Clostridium perfringens</i>)	T
Food safety threats (e.g., <i>Salmonella</i> species, <i>Escherichia coli</i> O157:H7, <i>Shigella</i>)	B
Glanders (<i>Burkholderia mallei</i>)	B
Melioidosis (<i>Burkholderia pseudomallei</i>)	B
Psittacosis (<i>Chlamydia psittaci</i>)	B
Q fever (<i>Coxiella burnetii</i>)	B
Ricin toxin (from <i>Ricinus communis</i> —castor beans)	T
Staphylococcal enterotoxin B	T
Typhus fever (<i>Rickettsia prowazekii</i>)	B
Viral encephalitis (alphaviruses such as Venezuelan equine encephalitis, eastern equine encephalitis, western equine encephalitis)	V
Water safety threats (e.g., <i>Vibrio cholerae</i> , <i>Cryptosporidium parvum</i>)	B
Category C^e	
Emerging infectious diseases such as Nipah virus and hantavirus	V

^a Available at <http://www.cdc.gov>. Accessed August 2003.

^b B = bacterium; V = virus; T = toxin.

^c Category A includes the highest priority agents that pose a risk to national security because they can be easily disseminated or transmitted from person to person; result in high mortality rates and have the potential for major public health impact; might cause public panic and social disruption; and require special action for public health preparedness.

^d Category B agents are the second highest priority and include those that are moderately easy to disseminate; result in moderate morbidity rates and low mortality rates; and require specific enhancements of CDC's diagnostic capacity and enhanced disease surveillance.

^e Category C agents are the third highest priority and include emerging pathogens that could be engineered for mass dissemination in the future because of availability; ease of production and dissemination; and potential for high morbidity and mortality rates and major health impact.

The committee was asked to consider two scenarios of biological agent attack: an indoor release against the population of a building and an outdoor release against an extended military installation. As it considered these two scenarios, the committee recognized that buildings and facilities in which humans congregate will typically be easier targets for controlled attack than outdoor areas or military installations. Given the finite nature of enclosed spaces, minimal ambient ultraviolet light, and controlled air movement, a building will generally be an easier target than any open space. This conclusion is consistent with the experience of the anthrax letters, in which a small quantity of spores contained in a few envelopes resulted in exposure to personnel and required decontamination of several large office buildings and mail-handling facilities.

Conversely, an attack involving the release of a cloud of agent upwind of a military facility requires a much larger quantity of weaponized agent and must contend with exposure of the agent to ultraviolet light

as well as physical disruption by thermals or irregular air currents found in most large installations. At the right time of the day, more humans will be more vulnerable to a respirable aerosol threat in an enclosed space than outside, and indoor "weather" will almost always favor the attacker. Fortunately, however, enclosed spaces can be more easily provided with collective artificial protection than open spaces.

In view of the comparative simplicity and advantages to the attacker in the indoor scenario, as well as the richness of potential defensive responses, the committee focused most of its attention on detect-to-warn technologies for this scenario. However, it also considered the applicability of these technologies to the outdoor release scenario.

The committee found that Task 4 was the most challenging. This is because most of the technologies discussed in this report are not yet mature enough to support a discussion of specific materials, system design, or manufacturing issues. However, for the more mature technologies discussed, the committee attempted to highlight the key enabling technologies that will facilitate their deployment as effective detect-to-warn sensor systems.

Looking beyond the tasks assigned by DTRA, the committee also notes that the overall system to counter potential biological agent attacks must balance the advantages and limitations of detect-to-warn systems with other alternatives for protecting people. The best overall biodefense architecture will likely be a system-of-systems that includes not only detection systems but vaccines, therapeutics, collective protection, and other means of protecting personnel in facilities and installations. The analysis and balancing of these major defensive components is as essential as the pursuit of the promising detection-based architectures addressed in this report.

CONCLUDING THOUGHTS

Although the United States could some day be faced with such "designer" agents as bacteria containing genes coded for new virulence factors, viruses designed to target cell populations that they ignore in nature, or small, bioactive natural molecules not currently on any threat list, many of the principles discussed in this report will still apply 50 years from now. Infection and effective doses will remain the same. Most biological threats will be neither volatile nor dermally active; therefore, unless the agents are easily spread from person to person, the attacker will most often find it necessary to disseminate them in particles small enough to hang suspended in the air long enough to be inhaled by the intended victim in quantities large enough to cause disease.

For outdoor releases, weaponeers may achieve breakthroughs in ultraviolet protection that will allow stabilization of bacteria, viruses, proteins, and peptides, but the sun's heat will always spawn thermals and winds that move particles along with them, lending uncertainty to the intended cloud trajectory. Resting humans will still ventilate to obtain oxygen and expire CO₂ in volumes ranging from 5 to 10 liters per minute. The cost and effectiveness of the sensors, the configuration of the facilities they protect, and the threat itself will continue to evolve. The most stable variable in this complex equation may be the human body and the life we seek to protect.

In the future, it will be necessary to make hard decisions regarding the protection of humans from biological threat agents. The purpose of this study is to assist homeland defense officials, hardware and policy developers, and, specifically, program managers within the Department of Defense to understand key state-of-the-art technologies, barriers, and enablers that might lead one day to effective biosensor systems for protection of buildings and installations.

2

Scenarios, Defensive Concepts, and Detection Architectures

The capabilities of currently available sampling and detection systems have made them increasingly useful for defense against attacks involving aerosol dispersal of biological agents. Over the past decade, a succession of military detection systems has been developed by the United States to protect critical assets and deployed forces. These systems include the Biological Integrated Detection System (BIDS), Joint Portal Shield, and, more recently, the Joint Biological Point Detection System (JBPDS).¹ The slow response time of these systems (about 20 minutes plus communication, decision, and response delays) makes them most useful for initiation of medical treatment of exposed personnel following a biological release event. This "detect-to-treat" response can be quite effective in the reduction of casualties, as the effects of many biological warfare agents can be dramatically reduced through timely medical treatment. Even longer detection times can also be valuable for detect-to-treat responses to domestic attacks. For example, the Biological Aerosol Sentry and Information System (BASIS),² developed by the Department of Energy for domestic deployment at special events, employs a much longer (i.e., several hours) response cycle that allows attainment of the very high levels of certainty that are required for major civilian medical responses.

This chapter introduces several generic but representative scenarios in which a biological aerosol is released against target sets of interest. Taken together, these scenarios encompass many of the most likely and threatening prospects that were presented to the committee in briefings and supporting documentation. Based on these scenarios, the committee lists attributes of detector technologies that are most important in future detect-to-warn architectures and discusses trade-offs among them. Early detection plays a major role in the successful execution of the postulated concepts.

The committee then proposes a framework for consideration of defensive systems. This framework stresses the critical importance of matching detector attributes to the capabilities of the response system. The discussion of detector attributes and architectural principles provides a context for the detailed review of detector technologies in the chapters that follow. Later, in Chapter 10, the committee revisits these principles to address the integration of detection systems within the detect-to-warn defensive

¹ Office of the Deputy Assistant to the Secretary of Defense (Chemical Biological Defense). 2002. Department of Defense Chemical and Biological Defense Program, Volume I: Annual Report to Congress. April.
Office of the Deputy Assistant to the Secretary of Defense (Chemical Biological Defense). 2002. Joint Service Chemical and Biological Defense Program, FY 02-03 Overview. April.

² U.S. Department of Energy, National Nuclear Security Administration, Office of Nonproliferation Research and Engineering. 2002. Chemical and Biological National Security Program: FY01 Annual Report (Technical Appendix). DOE/NA-03, March.

architectures. Chapter 10 also provides more specific insight into factors that influence overall performance, including those that are outside the detection system.

The scenarios and defensive concepts in this report were created to provide guidance on the environments and top-level requirements for the detection systems that enable detect-to-warn architectures. Development of more detailed system specifications and operational concepts was not undertaken as part of this study. Future design efforts that address detect-to-warn systems and their operations must build upon the growing experience base derived from federal demonstration programs, including DoD and its Advanced Concept Technology Demonstration (ACTD) programs. Several past ACTDs (for example, the Joint Biological Remote Warning System) addressed biological defense operations in the field. More recent work in the Restoration of Operations ACTD has focused on protection and response to chemical and biological attacks on fixed sites. The operational concepts developed in these past demonstration programs should be evaluated in future system design studies, although they may be of limited value since none have focused on the detect-to-warn architectures discussed in the study. In addition, a formal red teaming³ and countermeasure evaluation must be a part of the next stages of defensive architecture design. The committee did not evaluate the tactics that could be employed by an attacker to defeat the conceptual defenses postulated in this report.

It should also be noted that the detect-to-warn approaches outlined here are not the only component in a comprehensive system to protect personnel from the effects of a biological attack. An overall biodefense architecture can include medical countermeasures (e.g., vaccines and therapeutics) as well as personal and collective protection systems. An approach for balancing research, development, and deployment efforts in this larger arena is an important research topic but is beyond the scope of this study.

SCENARIO SELECTION AND DEFENSIVE CONCEPTS

Credible scenarios for biological agent release against targets of concern are the starting points for development of defensive concepts and detection system requirements. Attack scenarios can generally be divided into two categories. The first involves outdoor releases designed to threaten distributed target complexes (e.g., military bases, deployed forces, naval task forces) or broad area targets (e.g., cities). The second involves direct attacks on specific facilities through agent release into an interior area or into the intake of the air handling system.

Outdoor Release Scenarios

Outdoor releases that cover a distributed area have long been a focus of military concern. Such attacks can threaten forces in the field, operational bases, seaborne task forces, and other critical power projection assets. Outdoor attacks that employ a fully weaponized agent exploit the full potential for wide area impact offered by biological agents. The scenarios developed in an earlier study effort and provided in support of committee deliberations⁴ emphasize the effect of outdoor releases on a variety of military targets. These scenarios usually employ a line release of aerosolized agent, although the type of agent employed, the timing and extent of the attack, and the resulting areas impacted differ widely. Others have postulated similar broad area attacks on U.S. cities, frequently employing the same line release deployment schemes.⁵ While line releases are often the tactic of choice, other options, including point releases, may be more suitable for less sophisticated attackers, for surreptitious release in a protected area, for attack of specific targets, or in response to defensive system deployments.

³ A "red team" is a group of independent reviewers organized to provide an objective assessment.

⁴ Advanced Systems Concepts Office, Defense Threat Reduction Agency, 2000. NBC Scenarios: 2002-2010, April.

⁵ U.S. Congress, Office of Technology Assessment. 1993. Proliferation of Weapons of Mass Destruction: Assessing the Risk, OTA-ISC-559. Washington, D.C.: U.S. Government Printing Office. Available online at <http://www.www.princeton.edu/cgi-bin/byteserv.prl/~ota/disk1/1993/9341/9341.PDF>.

A line release can be a very effective deployment tactic for sophisticated attacks against a distributed target complex or broad area target. Such a line attack can be generated by a ground vehicle or low-flying aircraft passing upwind of the target area. The length of the release is primarily determined by the extent of the target area, with appropriate allowance for shifts in wind direction for releases far upwind of the target area. Releases close to the upwind edge of the target area will yield a maximum agent concentration on target, since the cloud will not have time to fully disperse before it passes over the target. This will reduce the potential warning time for the defense, but the higher agent concentrations at the target perimeter may make initial detection of the cloud easier. Meteorological conditions will critically impact the success of an outdoor release. Relatively slow wind speeds and a temperature inversion to contain the agent will result in higher agent concentrations and relatively long dwell times in the target area. The relatively slow wind speeds (i.e., 5 to 8 meters per second) sought by an attacker can work to the benefit of the defense, however. Each kilometer of detector standoff at a wind speed of 5 meters per second buys the defense over 3 minutes for detection and response. An efficiently formed cloud can have lethal effects hundreds of kilometers downwind, although the targeted depth for most military complexes is much smaller. Physical security around bases and other fixed facilities is important to permit forward deployment of defensive assets. This not only increases defensive time lines but also drives up the minimum required release size for the attacker.

A point release of biological agent could be the best choice in some attack scenarios. This might occur when maximum agent concentration and duration of exposure on a specific facility is desired. Surreptitious release from a selected point might also allow closer approach to a targeted facility and avoidance of known detectors upwind of the facility. Such a tactic might be particularly useful against civilian facility targets where a large exclusion zone does not surround the target. The closest possible outdoor point release would be a release into the intake of a facility air-handling system, and this possibility must be addressed by facility defenses (discussed below). Point releases might also be chosen as a less complex way to attack extended targets (such as cities), where complete coverage of a distributed area is not a required outcome.

Facility Release Scenarios

Attacks against specific facilities are of increasing concern to military and civilian planners. An active program (the Immune Buildings Program) is currently being sponsored by the Defense Advanced Research Projects Agency (DARPA) to develop key technologies and systems integration concepts in this area.⁶ Facility attacks can be mounted with much less sophisticated technologies for agent fabrication and dispersal and require smaller release quantities than outdoor release scenarios. The uncertainties associated with outdoor meteorological conditions and agent durability are reduced or eliminated. Individual facilities can also have major iconic and functional value for both military and civilian organizations and offer the attacker a variety of options. The heating, ventilation, and cooling (HVAC) systems can be used to disperse the agent throughout the facility. The attacker can release agent in an accessible room or region of the facility. Releases directly into the exterior HVAC intakes or interior return ducts leading to air handling units can also be effective.

Military Versus Civilian Scenarios

No major distinctions are drawn between military and civilian targets in discussion of detection and response options. Facility and distributed target complexes for the military have direct analogs in the civilian sector. In many cases, military responses to detection of a biological agent could be more effective than those open to most civilian responders. This is due to the various defensive advantages that can be more easily incorporated into a military environment, including effective personal and collective protection gear, rapid command and control, extensive training, tolerance for disruptive

⁶ Amy Alving, DARPA Immune Building Program. Presentation to the committee on December 19, 2001.

emergency procedures, and robust health and immunity status of the personnel. However, the fundamental defensive architectures and resulting detection implications are expected to have similar applicability to both military and civilian targets.

DEFENSIVE CONCEPTS AGAINST ATTACKS ON FACILITIES

Consideration of facility defenses for protection against biological attacks was a central focus for the architecture and analysis work of this committee. There were a number of compelling reasons for this emphasis on facility protection. One was the high perceived likelihood that a perpetrator, particularly one constrained by unsophisticated technology or limited agent availability, would choose this path. Another was the potential to provide effective detect-to-warn defenses using relatively near-term detection technologies—for example, bioaerosol detectors (see Chapter 5). The development and demonstration of facility protection systems that employ affordable, near-term technologies would constitute an important step toward realization of a national biological defense strategy. The promise of facility defense, however, depends on several factors. These are outlined below and are examined in greater detail in Chapter 10.

Airflow control and air quality features often found in modern facilities, including isolation of independent air circulation zones and effective filtering, can provide opportunities for detection of releases in areas that have relatively high concentration levels. This is particularly true for interior releases over relatively short intervals (e.g., 1 to 10 minutes) where the local concentration near the release point can far exceed expected background levels. This effect also applies to defense against releases at the air handler outside intakes, although the immediate dilution by clean recirculated air within the air handler return plenum may reduce the relative margin over background levels.

Enclosed facilities offer a rich set of defensive responses that can be employed to reduce exposure of occupants in the event of a biological attack. With sufficient warning and attack characterization, the air handling system can be utilized to halt the spread of the agent. Isolation of separate air handling zones by physical barriers and balanced system operations can also dramatically reduce the extent of agent transport beyond the immediate release area. With early warning, evacuation paths may be cleared by appropriate air handler and exterior access strategies. Several passive measures that do not depend on the detection of a release may also be effective in reducing the magnitude of the attack and delaying its dispersion throughout the facility. Filtration or other air cleaning technologies can provide a substantial drop in agent concentration. New construction standards that increase the isolation of independent air handlers, accompanied by periodic pressure balancing of air handlers, can create facilities that disperse agents much less rapidly. These passive defense measures may also enhance the effectiveness of detectors by reducing reduction of the natural biological aerosol backgrounds inside the facility.

The defensive responses suggested in this study involve isolation of airborne agent near its point of release into the facility. This can often be accomplished by air handler responses that impede movement of the agent away from the release zone. While it is difficult to prevent exposure of facility occupants near the release point, appropriate responses can significantly reduce the exposure of individuals in spaces removed from the release area.

Facilities may also emerge as the core element of defenses against outdoor attacks on distributed target complexes such as military posts or bases. Various protective options that can be incorporated into facilities can be rapidly engaged upon notice of the approach of a threatening cloud. For example, facility air intakes and other external openings could be closed during passage of the cloud over the target complex. The air handling system could be shut down or modified to circulate only internal air. For critical facilities, positive pressure established using highly filtered sources could almost eliminate infiltration from an outdoor cloud. In many cases, particularly during early morning hours when biological release is optimal, a greater fraction of site personnel may be present within facilities rather than in an unprotected outdoors posture. During other periods, a strategy of moving personnel into facilities upon

cloud approach, followed by purging and decontamination of the facilities after cloud transit, may be a useful defensive measure.

DEFENSIVE CONCEPTS AGAINST ATTACKS ON DISTRIBUTED TARGET COMPLEXES

Detect-to-warn systems for defense of outdoor attacks on distributed target complexes must rely on detection of the released agent cloud at the perimeter of the complex or on standoff detection that characterizes the cloud before it reaches the target area.

For current systems that require 25 to 30 minutes to yield high-confidence responses, detectors would need to be deployed far in front of the protected targets in order to effect a detect-to-warn response. (For example, detectors must be placed at least 9 kilometers in front of the target area assuming a 30-minute detection and identification delay for a nominal wind speed of 5 meters per second. Higher wind speeds increase this distance even more.) Detection assets placed far forward of the defended targets also face other problems, including control and security or the possibility that the release points can be between the detectors and the target complex.

The size of the target area and the controlled buffer zone between the target and the perimeter of the controlled area also determine detector array sizing. Detector response time requirements may be particularly stringent in the case of foreign posts or bases, ports of debarkation, and military assets surrounded by cities, where the size of the controlled buffer zone can be very small.

For a line release, the extended cloud length means that a sparsely populated line of detectors will likely be sufficient for cloud detection. Deployment numbers will be driven by the need to prepare for attacks from a range of possible incident wind directions. For more localized point releases, a greater number of detectors will need to be deployed, including some away from the perimeter of the buffer zone. While a denser network of detectors is more costly to deploy, other benefits besides better coverage of attacks accrue. Closely spaced detectors will generally allow a more specific characterization of the direction and magnitude of an attack. They will also make the detection less vulnerable to uncertainties in the local meteorological variations near any given detector. Finally, nearby detectors serve as backups in the case of false alarms or detector malfunctions.

The nominal defensive concept for distributed target complexes hinges on the initial detection of a threatening cloud as far upwind as possible using spectroscopic point detectors at the perimeter of the defended area or standoff detectors that can identify clouds before they reach the defended perimeter. A detection alarm could, if sufficiently certain, trigger various protective actions within the defended complex. Site facilities could be placed in a defensive mode through air handling and physical isolation steps to reduce infiltration of outside air. At-risk personnel could be alerted to utilize protective face masks or seek shelter in a protected facility. Some of these actions, particularly those affecting facility airflows, could be implemented automatically and cause little disruption of activities in the facility.

The peak agent concentration in a line release cloud may be relatively low for attacks sized to threaten only unprotected personnel. If the attack is sized to achieve a high confidence of infection of personnel inside facilities, the incident concentration levels may be significantly higher to overcome the sheltering effects of well-designed facilities. If this is the case, attack levels may exceed background enough to enable rapid, nonspecific detection of the attack. This rapid detection could enable significant defensive actions to be taken, particularly in the control of airflows and intake into the site facilities threatened by the agent cloud. Portions of the potential scenario space in which such defensive responses could be significant are examined in Chapter 10.

Although a scenario involving a biological attack against a broad area (e.g., an urban civilian population) is not an explicit part of this committee's charge, it is worth commenting on some of the similarities and differences between this scenario and an attack on an extended military installation. Defense of broad areas against biological attack is a particularly difficult challenge for a detect-to-warn architecture. If high casualties are the principal goal of an attacker, an arbitrarily placed point release can provide a very large infective plume with relatively low concentration levels. Detection of such a release with an unknown release location will require an array of closely spaced detectors. Furthermore,

detection sensitivity requirements are high for optimally sized releases. The difficulties associated with defenses in this scenario may make a detect-to-treat system the preferred architecture for the foreseeable future.

KEY DETECTION SYSTEM ATTRIBUTES AND TRADE-OFFS

The ability of detector systems to enable effective defensive responses depends on the many attributes that characterize the acquisition and function of the detectors. Often there exist trade-offs among the major performance attributes that are under control of the detector designer. The most critical attributes that determine detector performance and their impact on defensive architecture design are outlined here. Several key trade-offs that drive single-detector design and detection systems design will also be highlighted.

Detector Performance Attributes in Detect-to-Warn Scenarios

The key requirement for facility defense architectures is timely response. Nominally, actionable information within 1 to 2 minutes is desirable. Such rapidly available information can, in some cases, be useful even if it is somewhat uncertain. This is particularly the case where a rapid, though less certain, alarm is followed by more specific verification in a timely fashion.

Required detector sensitivity for detect-to-warn operations depends on a variety of threat and architectural factors. The infectivity of the agent is a critical factor. Some agents require only a dozen or fewer particles to reach an infective dose, while others require thousands. This is illustrated by the infectivity data included in Table 2.1. Required detection sensitivity also depends on the magnitude of the release and the attenuation or dispersion between the release point and detector location. For many scenarios, detection alarm thresholds far above both normal background levels and the lethal levels for humans can be useful when the detector is placed close to the source or when a protective barrier isolates the source from the intended targets. These trade-offs will be explored in later discussions on defensive architectures. In addition to indications of the presence of an agent, detectors that provide estimates of agent concentration can support the characterization and estimation of the future trajectory of an agent cloud.

This specificity permits detectors to identify a small set of agents from a very diverse biological background. It can serve to reduce false alarm rates for detection, though often at the expense of much slower response times. Detectors that are nonspecific, such as those that detect and discriminate only biological versus nonbiological aerosols, can have very high false alarm rates if the alarm threshold is not well above the normal biological background levels. For attacks that result in biological signatures well

TABLE 2.1 Infectivity Levels for Several Biological Agents

Biological Agent	Infectivity Level ^a
Q fever (<i>Coxiella burnetii</i>)	<10
Smallpox (<i>Variola major</i>)	10-50
Tularemia (<i>Francisella tularensis</i>)	30-70
Plague (<i>Yersinia pestis</i>)	300-500
Anthrax (LD ₅₀) (<i>Bacillus anthracis</i>)	2,500-55,000

^a In colony-forming units for bacteria and plaque-forming units for viruses. Colony forming units (cfus) are counted colonies that result from either individual culturable organisms or particles containing multiple culturable organisms

above backgrounds, nonspecific detection alarm thresholds may be set high to avoid false alarm issues. Highly specific detection will continue to play an important role in the confirmation of rapid alarms from nonspecific sensors and in the detection of lower concentrations of biological agent that may result from scenarios that employ extended release periods or exterior releases that are drawn into the facility HVAC system.

Technologies that have the capability to recognize a wide array of potential threatening agents will be preferred in defensive applications. The committee also considered nonspecific detectors that respond to the functional impacts of agents on organisms. Such function-based detection processes may become even more important as the potential for engineered threats (e.g., agents created or modified genetically, structurally, or chemically to make them more lethal or less detectable) increases.

The committee notes that there are many other desirable attributes of detection technologies, including low acquisition and maintenance cost, minimal consumables and other logistics needs, high reliability, and capability for continuous operation. Low power requirements, small operational signatures, and compact packaging may also be needed for some specialized applications. Many of these attributes will become more important in the system engineering phase and the integration of the final deployable package.

Detection System Trade-offs

In real-world detection systems, designers must make trade-offs among the detector attributes introduced above. Several dominant trade-offs emerged frequently during consideration of detection technologies. These are outlined below.

Increased sensitivity is often associated with longer processing delays within a detector. For different types of technologies, this delay reflects very different physical constraints. These will be reviewed in conjunction with the specific technologies in later chapters. In addition, the use of longer sampling intervals, higher collection rates, and concentrators can increase system sensitivity at the expense of higher initial costs and longer detection delays. A particularly interesting trade-off exists between detector sensitivity and cost. If inexpensive detectors could be deployed near release points, they would be expected to experience relatively high agent concentrations. This could enable more rapid response and reduce the false alarm rate for even simple detectors. This concept of wide deployment of inexpensive detectors is motivating some developers to come up with the equivalent of a smoke detector for biological agents. (Such devices are called "biological smoke detectors" in this report.)

For the currently envisioned universe of detection technologies, higher specificity is generally associated with longer processing times. The capability for rapid but nonspecific detection has been proven. However, such systems respond to large classes of biological particles, so the ability to deal with false alarms must be an inherent part of the defensive system architecture. Even with highly specific assays, such as PCR or PCR/array hybridization (see Chapter 6), increasing specificity is achieved by amplifying and detecting more nucleic acid loci (higher multiplexing levels), which requires a longer assay time.

While most current detection technologies identify specific types of threat agents, one class of emerging detectors identifies specific functional impacts on surrogates for human cells. Such functional systems are able, in principle, to deal with unknown agents that might be developed by an adversary. These are discussed further in Chapter 9.

KEY ARCHITECTURAL DESIGN PRINCIPLES FOR DETECTION

The utility of a detection system must, in the end, be measured by the extent to which casualties are reduced and critical functions of the target are maintained. Effective response measures that can reduce the impact of an attack following its detection are indispensable in achieving this goal. Detection without the ability to respond can assist in identification and later medical treatment of affected personnel but has no value in the detect-to-warn mission.

The critical role of response options demands an end-to-end systems engineering approach to architecture design. The benefit resulting from investments in new response options might far exceed the impact of similarly costly efforts to improve detection. Improvements in response systems will usually be required to exploit the full capability of a detection system. Furthermore, the nature of the response that is available will often have a strong influence on the best choice of detection architecture.

A key interdependence of detection and response attributes is the relationship between detector false alarm rate and the severity of the response initiated when the detector alarms. For example, the range of active defensive responses can have widely differing impacts on both the personnel within a major facility and its operation. Some response actions, such as changes in HVAC air handler settings, are unlikely to cause near-term disruption of the activities under way within a facility. Actions that have limited or no impact on personnel or operations in an attack area are often termed "low-regret" responses. Other responses have more significant, though perhaps easily reversible, impacts on the personnel or function of a facility, particularly if a false alarm is confirmed in a timely fashion. These might include restraint or even evacuation of personnel, initiation of masking or other individual protective actions, or activation of barriers (e.g., air curtains) that significantly increase the isolation of different areas within the facility. Still other responses could be imagined that generate long-term or irreversible impacts on operations or that have potentially severe impacts on personnel. These might include facility shutdown, personnel decontamination, or initiation of medical treatment protocols. These latter responses can be termed "high-regret" options.

Clearly a detection system with a high false alarm rate cannot be employed to initiate high-regret responses. However, a relatively high false alarm rate detector might be used to trigger low-regret responses if a timely path is available to confirm the presence of a release and either reverse the initial responses or activate higher regret options that further respond to a confirmed event. This fundamental design principle can be exploited to match the performance of a detection system to the unique characteristics of a defended facility or site.

The concept of matching the intensity of the response to the quality of information emerging from the detection system is illustrated in Figure 2.1. Assuming a 1-minute cycle time for detection and decision actions, a false alarm rate of 10^{-3} (about one per day) might be tolerated for low-regret responses, depending on the nature of the confirmation process. High-regret options will likely require false alarm rates on the order of 10^{-6} (about one per year) or less. In a real defensive deployment, the impact on the facility operators of various levels of response to false alarms would need to be carefully evaluated. These standards may be very different for civilian and military applications and for different levels of alert status. The fundamental defensive principles remain:

- The level of response to detector alarms must be commensurate with the level of certainty of the alarm information.
- For facilities with the potential for graduated response steps, a multistage detection strategy may be optimal to permit early implementation of actions that can be easily reversed.
- Multistage detection and attack assessment may mandate the inclusion of several detection technologies into the overall system to build an increasingly accurate understanding of the nature of the unfolding attack.

Multistage Detection Architectures

The concept of multistage detection to provide increasingly stringent examination of initial alarms is not new. Such architectures are employed in military detection systems (e.g., the Biological Integrated Detection System, Portal Shield, and the Joint Biological Point Detection System), where fast detectors with relatively high false alarm rates are used to trigger further analysis by more specific detectors. For the military systems, this permits intermittent operation of the identification stages with the attendant reduction in consumables and other detector maintenance. However, this principle could be more generally applied to a much wider range of defensive architectures where earlier, higher false alarm

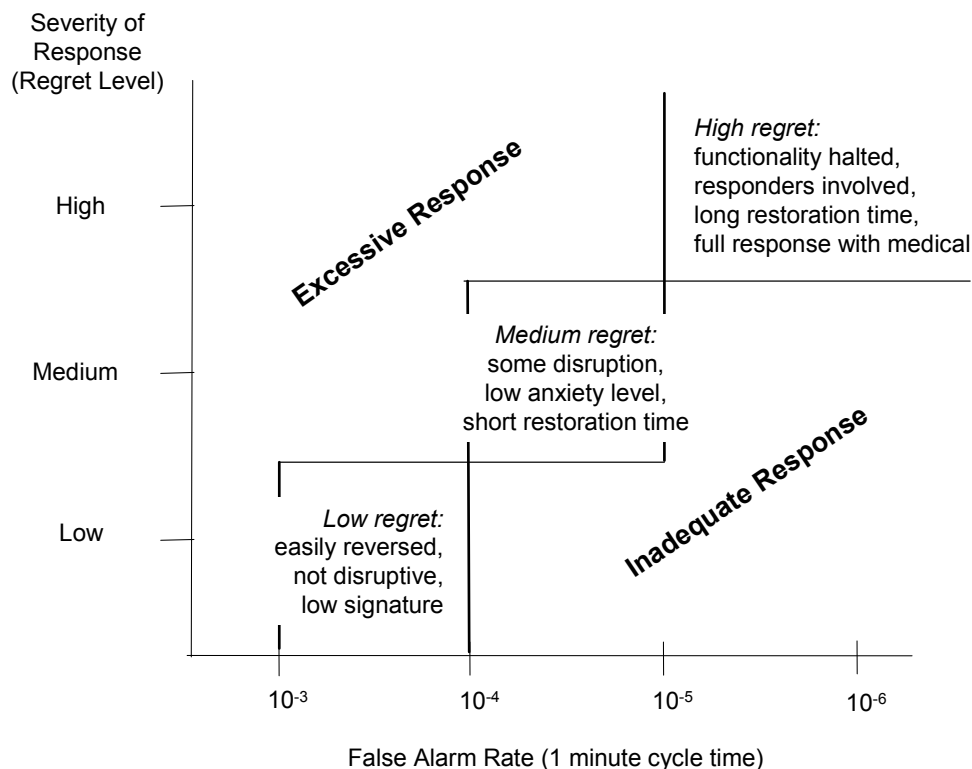

FIGURE 2.1 Matching response to information certainty.

detection stages might be used to initiate low-regret protective responses. Early warnings might also provide useful lead time to permit more successful execution of high-regret responses in the event of confirmation.

A generic multistage architecture is diagramed in Figure 2.2, where three stages of detection plus the essential sample collection and preparation element are indicated. As identifiers improve in speed, specificity, and sensitivity, one might imagine useful systems with two or even a single stage. As discussed in subsequent chapters, the committee believes that rapid, sensitive identifier technologies should be developed that could be operated in parallel with nonspecific detectors (as opposed to the series arrangement discussed for military systems above) to provide a reduced rate of false alarms and better protection against low-level attacks. At present, the response times of detectors that yield positive identification and confirmation of an attack are too slow to be operated in such a parallel manner. The discussions in subsequent chapters that address promising detection technologies will highlight evolutionary technologies that could significantly impact the generic multistage architecture presented here.

The rationale underlying the multistage detection approach can be illustrated by consideration of facility protection architectures. Bioaerosol detectors offer the advantages of being available in the near term, providing a rapid response, and responding to all biological particles, whether known or unknown, existing or novel. However, they are prone to false alarms, particularly if the detected particle concentrations are only slightly above average backgrounds. The relatively uncertain information generated by bioaerosol levels that are not far above background might be used to initiate low-regret responses such as modifications to the normal air handling (e.g., shutdown, airflow reversals, selective venting). Other useful low-regret options are available, including increasing surveillance of the potential

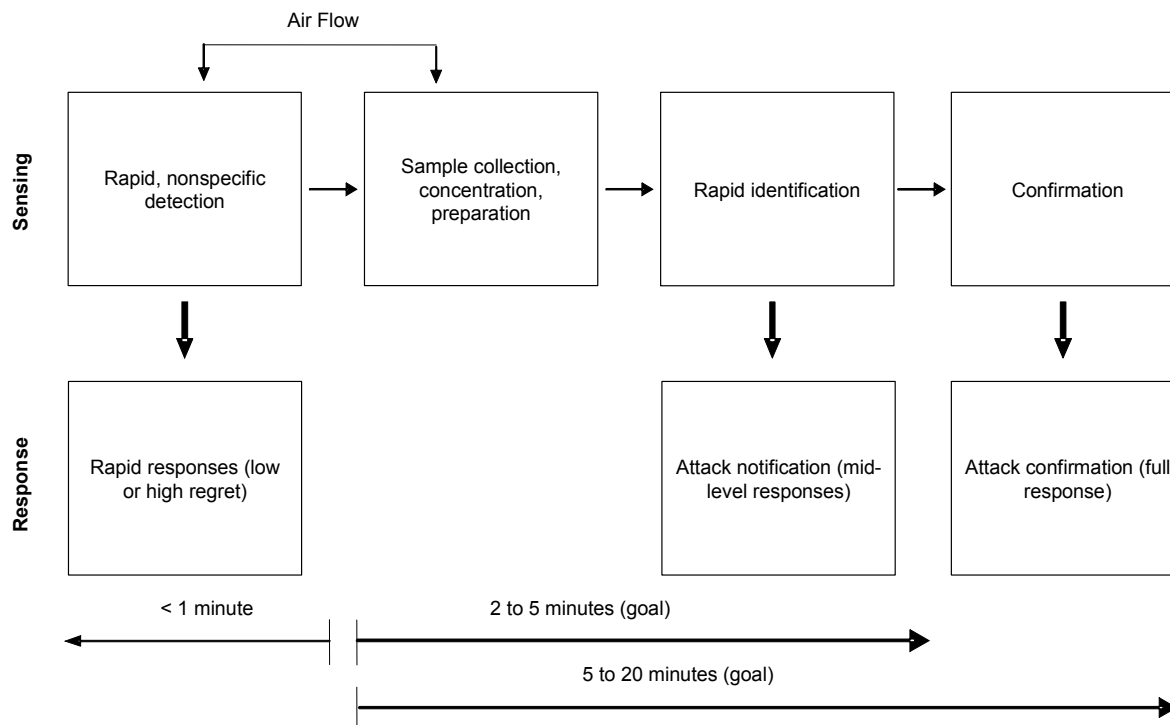

FIGURE 2.2 Generic multistage architecture.

release region, alerting nearby staff to note any irregularities, and reducing the personnel traffic into areas that might be affected should the release be confirmed.

If bioaerosol levels far higher than background are observed, or if a rapid identifier operated in parallel yields a positive report, more significant actions can be initiated. These might include evacuations, temporary personal protection measures, movement restrictions, and other actions that will disrupt or halt normal facility operations. Final confirmation of the attack by the most specific detection system will open the door to a full complement of responses, including medical measures and evaluation of the overall scope of the attack beyond the bounds of the facility. Even for very specific detectors, validation of the presence of an attack by a second detection technology may be valuable when the lowest possible false alarm rate is required.

Detect-to-Warn Architecture Performance

The end-to-end performance of a detect-to-warn architecture will depend on numerous factors, including scenario uncertainties, detection system capabilities, and response effectiveness. Examples of several nominal defenses are postulated and analyzed in Chapter 10. These examples point to the promise of significant defensive capability against some attacks. Many challenging analysis, design, and demonstration tasks remain before this promise is realized, not only for the detection technologies but also for the overall defensive system.

3

Indoor and Outdoor Bioaerosol Backgrounds and Sampling Strategies

Understanding the normal state of the bioaerosol environment is an essential precursor for detecting unusual concentrations or populations that would be associated with a release of biological agents. As discussed below, not only can natural bioaerosol backgrounds be large compared to the biothreat agents that must be distinguished, but concentrations can also vary rapidly over a wide range. Unless these variations are understood and accounted for, they could overwhelm nonspecific detectors or result in an unacceptable rate of false alarms. As discussed below, a major problem with existing data on bioaerosol concentrations is that the data are generally reported as time averages. Few studies have focused on maximum concentrations, which are critical for predicting detector false alarm rates.

This chapter begins with a discussion of the various types of organisms and their by-products that make up bioaerosols. Both traditional and new methods of detection are discussed, as are associated sampling errors. Consistent with the two basic scenarios for biological agent releases examined in this report (see Chapter 2), both indoor and outdoor bioaerosol backgrounds are considered, including current data on such aerosols, areas where critical data are lacking, and what approaches might be taken to provide the needed data. Current methods used for control of natural aerosols in buildings are discussed. Finally, the committee offers its findings and recommendations.

ORGANISMS AND PARTICLES

Environmental aerosols contain numerous different kinds of particles of different sizes. As an example, biological particles that may be present in indoor air are listed in Table 3.1. Inadequate data have been published to estimate or predict concentrations of most particle types. Question marks indicate areas where no size data are available. For the purposes of detection, all of the organisms share some characteristics. They contain organic carbon, amino acids, DNA and/or RNA, and other materials indicative of their biological origin.

The actual particles that are present in the air may be single organisms, groups of organisms glued together with mucous secretions or other materials (e.g., droplet nuclei), single or grouped spores, fragments of organisms, or organic or inorganic rafts bearing one to many organisms.¹

¹ T.M. Madelin and H.E. Johnson. 1992. Fungal and actinomycete spore aerosols measured at different humidities with an aerodynamic particle sizer. *J. Appl. Bacteriol.* 72:400-409.

TABLE 3.1 Biological Particles That May Be Present in Indoor Air and Their Sizes

Source Organism	Particle	Size Range (μm)	Common Examples	Unique Characteristics
Virus	One or more virions in droplet nucleus	<0.1-3	Influenza	Particle may be much larger than organism; RNA or DNA, not both
Mycoplasma	One or more organisms in droplet nucleus	1-5	M. pneumoniae	No cell wall
Chlamydia	One or more organisms in droplet nucleus	1-5	Chlamydia psittaci	
Rickettsia	One or more organisms in droplet nucleus	1-5	Coxiella burnetii	Obligate intracellular pathogen
Bacteria	One or more bacteria in droplet nucleus or on a raft	1-5	Micrococcus luteus	Variable in size, shape, cell wall composition
	Single or grouped dry spores	0.5-5 3	Bacillus cereus Thermoactinomyces	Highly resistant endospores
	Cell wall fragments	<0.1		
Algae	One or more cells	5-10	Chlorococcus	Chlorophyll, cellulose
Nonvascular plants	One or more spores	15-30	Mosses	Chlorophyll, cellulose
Vascular plants	Spore	15-30	Lycopodium ferns	
	Pollen	10-50	Trees, grasses, weeds	Sporopollenin
	Pollen allergens	?		
	Hairs	10-100		Cellulose
	Fragments	?	Soy beans	Cellulose
Arthropods	Fragments	?	Cockroach, dust mite	Chitin
	Fecal material	20-30		
Animals	Fragments	?	Cats, dogs, mice	Keratin
	Skin scales	10-50		
Fungi	One or more spores	1.5-100	Mushrooms, aspergillus	Chitin
	One or more hyphae	1.5-100		Ergosterol
	Fragments	?		1-3 β -D-glucan

Particle sizes range from less than 0.1 micrometers to more than 100 micrometers and can vary with relative humidity. Spores are generally smaller in air than when mounted in liquid media for microscopy. In addition to particles directly derived from living organisms, other particles in air may also share properties with the bioaerosols. Some examples include latex particles and combustion products derived

from burning biological materials (e.g., tobacco). Some of these particles may carry other biological material (e.g., allergens).²

No single sampling or analysis approach will accurately measure the concentrations of all biological particles. The types and concentrations of particles recovered depend on both the size selectivity of the sample collector and the sensitivity and specificity of the analytical method.

Although samplers can be designed to collect particles over a relatively broad range of sizes (see Chapter 4), those currently in use are size-selective and misrepresent the true size distribution of the aerosol. Most bioaerosol samples are collected with impactors, impingers, or filters, depending on the type of target particle and the preference of the investigator. Each of the collection devices has a value of d_{50} —that is, the aerodynamic diameter³ that is collected with 50 percent efficiency. Good samplers have a steep diameter-efficiency curve, so that 100 percent efficiency is only a small step above the d_{50} . Because bioaerosols have a broad range of sizes—between 1 and 100 micrometers (μm)—the d_{50} and the steepness of the efficiency curve are extremely important factors.

The Andersen cascade impactor is commonly used to collect both indoor and outdoor culturable aerosols. It is highly efficient down to a particle size of 0.1 μm and collects those above 10 μm with reasonable efficiency provided the unit is wind-oriented and the inlet air speed is close to the suction speed. However, some investigators use other devices (with much lower efficiencies) for sample collection. For example, a centrifugal sampler with poor (less than 10 percent) collection efficiency for particles smaller than 5 μm has been used in a number of studies. Thus, the data from these studies underestimate the actual concentrations of culturable organisms, and the underestimates are larger for small particles.

The rotorod sampler (a rotating arm impactor with a d_{50} of about 20 μm) is commonly used in the United States for outdoor pollen and fungal spore collection. It is excellent for pollen but drastically underestimates concentrations of the majority of (smaller) fungal spores. The Burkard spore trap is another commonly used instrument for measuring pollen and spore concentrations. It is reasonably efficient for spores, with a d_{50} of about 2.5 μm or less, depending on the slit width. It is also efficient for pollen providing the sampler is properly wind-oriented and the wind speed is not too high.

Indoors, several impaction spore traps and filtration methods are used. The slit samplers (Burkard, Air-O-Cell, Allergenco) have d_{50} s in the range 2.5 to 5 μm . Thus, while spore concentrations are underestimated to some extent, the fact that nonculturable spores can be counted probably far outweighs the losses of smaller spores. Filtration devices collect all particles larger than the pore size by interception and, in addition, very small particles by diffusion. However, they are not amenable to most of the traditional analysis methods. Cells trapped on a filter tend to dry out and die in the flowing airstream, and microscopy is difficult due to the large area and nonrandom deposition of cells. These may well be the samplers of the future, when deoxyribonucleic acid (DNA) or immunological (structure-based) assays are the norm.

ANALYTICAL METHODS

All methods for sample analysis are selective. Table 3.2 outlines data derived from a range of sample analysis approaches and notes various limitations of each. Errors introduced by selective analytical methods far outweigh errors due to sample collection efficiencies. All analytical methods are selective in some way, and to suggest that any one approach gives information on total organisms is indefensible.

One of the most commonly used analytical methods involves cell culture. However, this method only recovers organisms that are viable, that can grow on the culture medium and under the conditions

² R.B. Knox, C. Suphioglu, P. Taylor, R. Desai, H.C. Watson, J.L. Peng, and L.A. Bursill. 1977. Major grass pollen allergen Lol p 1 aerodynamic particle sizer. *J. Appl. Bacteriol.* 72:400-409.

³ The aerodynamic diameter of an arbitrary particle is the diameter of a sphere with density of 1 g/cm^3 that settles at the same terminal velocity as the particle in question.

TABLE 3.2 Limitations of Some Common Analysis Methods

Analysis Method	Types of Organisms Counted	Limitations
Culture	Living organisms capable of growing under conditions provided, e.g., <i>Aspergillus fumigatus</i>	Underestimates concentration of all organisms; nonculturable organisms are invisible; nonculturable is not the same as noninfective
Microscopy	Morphologically identifiable particles, e.g., grass pollen	Identification limited to groupings of organisms (genera, groups of genera, spore types)
Immunoassay	Particles with specific epitopes matching the assay antibodies, e.g., <i>Alternaria</i> allergen	Limited to organisms for which assays have been designed; cross-reactivity common
PCR	DNA matching the assay DNA, e.g., <i>Bacillus anthracis</i> DNA	Limited to organisms for which assays have been designed; very specific; very sensitive
Chemical assays	Biomass of specific chemical, e.g., total ergosterol or ATP	Indicators for large groups of organisms

provided, and that can compete with other organisms in the culture. This means that only the fastest growing organisms are recovered, and only those that are easiest to culture. Data documenting these relationships are abundant. For example, Reponen et al. recovered only 0.5 percent of *Thermoactinomyces vulgaris* by cultural methods compared with direct counting.⁴ In animal handling facilities, where an abundance of living organisms is to be expected, Eduard and Lacey recovered only 0.5 percent of the bacteria and 3 percent of the fungi detected by direct count methods.⁵ The culturability also varies with a number of factors, so that the errors introduced are not constant.⁶

This variability in errors over time is exemplified by a study in Oregon in which fluxes of bacteria from agricultural fields were assayed by three methods: total cell counts (epifluorescence microscopy), total culturable bacteria (impinger), and size-selective cultural (cascade impactor) samplers. Differences in cell concentrations were documented among the methods; these differences varied with season and weather conditions.⁷ Prime examples of the selectivity of culture are represented by *Legionella* and by *Pneumocystis carinii*. *Legionella* is a bacterium with very stringent cultural requirements; it is never recovered on ordinary laboratory media and does not compete well even when ideal conditions are provided. Thus, it is still not clear how many cells are released from even the most heavily contaminated reservoir. *Pneumocystis carinii* is a nonculturable fungus that is responsible for much of the pneumonia in AIDS patients. It was predicted to be an airborne disease based on epidemiological theories and was only recently identified in air samples following development of DNA probes for analysis. Because of these problems, all cultural data represent underestimates of culturable organisms and completely miss those that are not culturable. These errors are probably at least two or three orders of magnitude.

⁴ T.A. Reponen, S.V. Gazonko, S.A. Grinshpun, K. Willeke, and E.C. Cole. 1998. Characteristics of airborne actinomycete spores. *Appl. Environ. Microbiol.* 64:3807-3812.

⁵ W. Eduard, J. Lacey, K. Karlsson, U. Palmgren, G. Strom, and G. Blomquist. 1997. Evaluation of methods for enumerating microorganisms in filter samples from highly contaminated occupational environments. *Am. Ind. Hyg. Assoc. J.* 51:427-436.

⁶ C. Beggs. 2002. A quantitative method for evaluating the photoreactivation of ultraviolet damaged microorganisms. *Photochem. and Photobio. Sci.* 1:431-437.

Y. Tong and B. Lighthart. 1998. Effect of simulated solar radiation on mixed outdoor atmospheric bacterial populations. *FEMS Microbiol. Ecol.* 26:311-316.

J.F. Heidelberg, M. Shahamat, M. Levin, I. Rahman, G. Stelma, C. Grim, and R.R. Colwell. 1997. Effect of aerosolization on culturability and variety of gram-negative bacteria. *Appl. Environ. Microbiol.* 63:3585-3588.

⁷ Y. Tong and B. Lighthart. 2000. The annual bacterial particle concentration and size distribution in the ambient atmosphere in a rural area of the Willamette Valley, Oregon. *Aerosol Sci. Tech.* 32:393-403.

R.A. Haugland, J.L. Heckman, and L.J. Wymer. 1999. Evaluation of different methods for the extraction of DNA from fungal conidia by quantitative competitive PCR analysis. *J. Microbiol. Meth.* 37:165-176.

Microscopic spore counting also is selective and is restricted to those particles that are morphologically distinctive. Thus, some inorganic particles resemble spores, and some spores resemble inorganic particles. Also, microscopic examination offers relatively little opportunity for accurate identification of most particles. Pollen grains are usually classifiable only by genus, and in some cases only by groups (e.g., grass pollen). Basidiospores and ascospores, the most abundant spore types present in outdoor air, are usually identifiable only as a member of one or the other class, and errors are significant for the smallest and least distinguished of these. A few fungi have distinctive spores that are identifiable to species (e.g., *Epicoccum nigrum*). Most others can be placed only in generic categories.

Chemical assays for cell wall components (e.g., glucans), endotoxins, or membrane components (e.g., ergosterol) have been used for analysis but do not provide particle type or size information and recognize all organisms with these components with no differentiation.

Haugland et al.⁸ have developed a series of polymerase chain reaction (PCR) primers (see Chapter 6) for use in a quantitative method for detecting specific fungi. However, they have only been used for dust samples at this point. Haugland et al.⁹ and Schafer et al.¹⁰ have developed and used a PCR-based method for measurement of *Mycobacterium* concentrations, but this approach has not come into common use for other bacteria. Immunoassays also exist for many microbial components. However, none of these new approaches has been used to document background concentrations of bioaerosols.

Rotorods collect integrated samples over (usually) 24 hours. Spore traps usually offer some time discrimination capability, but the samples are usually analyzed in 24-hour units and only 24-hour averages reported. This has the effect of underestimating the impact of pollen and spores as background aerosol particles, since the particles tend to be released during relatively short periods of time, between which concentrations can be essentially zero. Peaks may be several orders of magnitude higher than average levels so that, while average levels may range from 1 to 10 particles per liter, peaks may reach 100 or even 1,000 particles or more per liter.

SOURCES OF BIOAEROSOLS

Estimating or formally predicting the nature of bioaerosol populations depends on recognizing environmental sources and their characteristics. Table 3.3 summarizes some of these sources for outdoor aerosols. Specific particle types are discussed below.

Outdoor Pollen

Pollen concentrations are seasonal and depend on the distribution and life cycle of source plants. Generally, there are three major pollen seasons: trees (spring), grass (late spring/early summer), and weeds (summer/early fall). There is a period during midsummer when pollen levels can be quite low, and counts remain near zero during the winter in climates with freezing weather.

Pollen is usually released during specific hours (often early in the morning), but pollen peaks may occur much later.¹¹ Release times depend on cycles of pollen production, mechanisms of pollen release, and on secondary aerosolization. For example, ragweed pollen is released in the still morning hours as plants begin to dry. Pollen falls onto subtending plant surfaces from which most aerosols are formed as a result of afternoon wind action. On the other hand, mountain cedar pollen is shaken directly into the air from pollen sacs, often forming visible clouds with pollen concentrations well in excess of 10,000 particles per liter.

⁸ Haugland et al., 1999. See note 7 above.

⁹ Haugland et al., 1999. See note 7 above.

¹⁰ M.P. Schafer, J.E. Fernback, and S.A. Jensen. 1998. Sampling and analytical method development for qualitative assessment of airborne mycobacterial species of the *Mycobacterium tuberculosis* complex. *Am. Ind. Hyg. Assoc. J.* 59:540-546.

¹¹ J. Norris-Hill. 1999. The diurnal variation of Poaceae pollen concentrations in a rural area. *Grana* 38:581-585.

TABLE 3.3 Overview of Sources for Outdoor Bioaerosols

Particle	Natural Sources	Source Characteristics	Man-made Sources	Source Characteristics
Viruses	Infected organisms	Probably ubiquitous	Sewage, other?	Point sources; sporadic
Bacteria and related particles	Living leaf surfaces	Ubiquitous	Sewage	Point or line sources, sporadic
	Dead leaf surfaces		Compost	
	Water		Cooling towers Biopesticides	
Fungal particles	Mushrooms, puffballs	Ubiquitous	Compost	Point sources, variable
	Infected plants		Infected agricultural products	
	Dead plants		Colonized dead field crops	
	Fecal material (i.e., animal droppings)		Stored dead organic material (grain, straw, etc.), biopesticides	
	Water			
	Soil			
Pollen	Vascular plants	Ubiquitous	Agricultural plants	Large point sources, variable
Other plant particles	Ferns, mosses, clubmosses, horsetails, mosses, liverwort, algae	Cosmopolitan, variable	Horticulture, aquaculture, seed/grain powders	Small area sources, variable
Other aerosols	Arthropods	Cosmopolitan, variable	Sewage, stored food	Point sources

The condition of pollen sources strongly affects pollen production. Recent studies have reported the effects of El Niño on pollen concentrations (it increases them) and the similarly positive effects of increasing CO₂ in ambient air.^{12,13} Some sources (e.g., trees) are driven by conditions pertaining during the previous season while others (grasses, weeds) are more driven by current conditions. Weather strongly affects airborne pollen concentrations as well, with levels near zero during precipitation events. Pollen clouds can be transported for long distances.^{14,15}

Events that can trigger large pollen releases generally involve disturbance of pollen reservoirs. For example, mowing a field of grass during active pollination will lead to sharp increases in pollen counts and probably in small particle pollen aerosols. The size distribution of pollen aerosols may shift toward smaller particle sizes during sharp changes in humidity such as occur during thunderstorms; this effect is due to release of starch grains as the internal pressure in the pollen increases due to water absorption. As mentioned above, sudden wind events can also trigger massive short-term pollen releases.

¹² H.B. Freye, J. King, and C.M. Litwin. 2001. Variations of pollen and mold concentrations in 1998 during the strong El Niño event of 1997-1998 and their impact on clinical exacerbations of allergic rhinitis, asthma, and sinusitis. *Allergy Asthma Proc.* 22:239-247.

¹³ J. Emberlin. 1994. The effects of patterns in climate and pollen abundance on allergy. *Allergy* 49(18 Supp):15-20.

¹⁴ P.V.d. Water and E. Levetin. 2001. Contribution of upwind pollen sources to the characterization of *Juniperus ashei* phenology. *Grana* 40:133-141.

¹⁵ H.A. Burge and C.A. Rogers. 2000. Outdoor allergens. *Environ. Health. Persp.* 108 Suppl 4:653-659.

Pollen Grain Concentrations

A reasonable amount of data has been published concerning whole pollen concentrations throughout the world. In the United States, pollen prevalence patterns have been monitored for many years by the American Academy of Allergy, Asthma, and Immunology, in Milwaukee, Wisconsin.¹⁶ Airborne pollen concentrations and types are seasonal and geographically variable.¹⁷ Reported pollen concentrations depend primarily on the quality of the counting, which requires training and patience. Two sites in a single city may report drastically different concentrations, especially for specific pollen types. On the other hand, on a weekly average basis, two geographically similar cities may have highly correlated pollen concentrations.¹⁸

Many pollen concentration studies have been published. Virtually all are based on 24-hour average pollen concentrations. Yearly peaks for pollen generally fall into the 300 to 500 particles per cubic meter range. However, as stated above, airborne pollen concentrations are diurnal, with peaks occurring over a relatively small portion of a 24-hour day. Thus, minute-by-minute peaks can be very high (more than 10,000 per cubic meter) while the remainder of the day may be near zero.

Pollen Allergen Concentrations (Including Small Particles)

Seasonal prevalence patterns for outdoors as determined by pollen counts are probably indicative of both outdoor small-particle allergen prevalence and indoor levels of pollen and pollen allergens.¹⁹ A number of studies have related rainfall and release of allergen from pollen grains.²⁰ Data on relationships to asthma indicate either a long-delayed response to pollen exposure or release of allergen during rainfall.²¹ Measured allergen concentrations in Melbourne were 6 to 15 nanograms per cubic meter during the grass pollen season. Allergen peaks more or less parallel pollen peaks but tend to follow them (on a 24-hour average basis).²²

Microscopic visualization of pollen allergen has been accomplished using spore trapping and immunoassays. Quantitative estimates of allergen concentration were made, and allergen was associated with pollen grains, pauci-micronic particles, and fungal spores.

Outdoor Fungi

Fungi colonize most living leaves and all dead ones. Leaf populations are readily released into the air with wind and rain splash, with different organisms/particles being released under different environmental conditions. Generally, dry fungal spores are most likely to be released in dry windy weather, while wet spores become abundant during damp and wet weather. Soil is another important source for all kinds of biological particles, although aerosolization from plant sources is probably more important. Aerosols are released from soil during mechanical disturbance (rain splash, wind, human and

¹⁶ Available online at <http://www.AAAAI.org>. Accessed August 2003.

¹⁷ H.A. Burge and C.A. Rogers, 2000. See note 15 above.

¹⁸ D.J. Dvorin, J.J. Lee, G.J. Belecanech, M.F. Goldstein, and E.H. Dunsky. 2001. A comparative, volumetric survey of airborne pollen in Philadelphia, Pennsylvania (1991-1997). *Ann. Allergy. Asthma Im.* 87:394-404.

¹⁹ M.K. Agarwal, J.W. Yunginger, M.C. Swanson, and C.E. Reed. 1981. An immunochemical method to measure atmospheric allergens. *J. Allergy Clin. Immun.* 68:194-200.

²⁰ A. Celenza, J. Fothergill, E. Kupek, and R.J. Shaw. 1996. Thunderstorm associated asthma: A detailed analysis of environmental factors. *British Medical Journal* 312(7031):604-607.

G.F. Schappi, C. Suphioglu, P.E. Taylor, and R.B. Knox. 1997. Concentrations of the major birch tree allergen Bet v 1 in pollen and respirable fine particles in the atmosphere. *J. Allergy Clin. Immun.* 100:656-661.

²¹ Celenza et al., 1996. See note 20 above.

²² G.F. Schappi, P.E. Taylor, M.C. Pain, P.A. Cameron, A.W. Dent, I.A. Staff, and C. Suphioglu. 1999. Concentrations of major grass group 5 allergens in pollen grains and atmospheric particles: Implications for hay fever and allergic asthma sufferers sensitized to grass pollen allergens. *Clin. Exp. Allergy* 29:633-641.

animal activities).²³ Highly infectious fungal diseases (e.g., coccidiomycosis, histoplasmosis) are spread directly from soil.

The fungal life cycle is controlled in part by climate. Many fungi spend the winter in resting stages and produce sexual spores in the spring. These sexual spores germinate to form new fungal mycelia, which then produce asexual spores later in the season. For many fungi that produce large fruiting bodies (e.g., mushrooms) mycelia expand throughout the growing season and the fruiting bodies are produced and release spores in the fall. Thus, concentrated basidiospore aerosols often occur in the fall.

Most fungi rely on the atmosphere for transport and spread, and many have developed remarkable mechanisms to insert spores into the air. Most of the mechanisms depend on water in some way, and spores show marked periodicity based on the water content of the air. Many spores are released early in the morning, when the dew point is reached (e.g., basidiospores).²⁴ Others become abundant later in the day, when drying causes the conidiophores to twist, shaking spores loose (e.g., *Cladosporium*).

Rain events cause splash-dispersed spores to become abundant and induce forcible spore release in the ascomycetes. Ascospore concentrations can reach levels well in excess of 1,000 per liter during light rain.

Human activity, such as farming, can also produce major spore plumes. When field crops are harvested after the grain matures, huge numbers of spores are released to the extent that spore clouds become visible. Even in air-conditioned combine cabs, spore concentrations can reach more than 10,000 per liter, and levels within the cloud are more likely to be greater than 10^7 per liter.²⁵ Another example is composting. Clouds of *Aspergillus fumigatus* spores (more than 1,000 per liter) and other spores are released from yard waste compost when the compost is disturbed.²⁶

Spore Concentrations

Several studies that document the broad range of spore concentrations that can be present in outdoor air are listed in Table 3.4. Note that most of the values shown here are averages. Cultural counts are averages or ranges of multiple grab samples, each collected over 1 to 5 minutes. The spore counts are generally a 24-hour average. Most spore reports drastically underestimate concentrations, primarily because many investigators lack the training and dedication required to count small colorless spores accurately. When properly counted, even ambient levels are frequently in excess of 50 per liter, and hourly averages can be greater than 200 per liter.²⁷

The problem of averages discussed above also applies here. Molina et al.²⁸ report 24-hour average levels over a year of greater than one spore per liter of air. Considering that *Cladosporium* is strongly diurnal and seasonal, this means that daily averages could be 10 to 100 per liter, and hourly averages could easily exceed 1,000 per liter.²⁹

As for pollen, fungal components have been detected in air in the absence of countable particles. Several investigators have measured the allergen content of particle-free air.³⁰

²³ A.A. Kwaasi, R.S. Parhar, F.A. al-Mohanna, H.A. Harfi, K.S. Collison, and S.T. al-Sedairy. 1998. Aeroallergens and viable microbes in sandstorm dust. Potential triggers of allergic and nonallergic respiratory ailments. *Allergy* 53:255-265.

²⁴ W.G.D. Fernando, J. Miller, L. Seaman, K. Seifert, and T.C. Paulitz. 2000. Daily and seasonal dynamics of airborne spores of *Fusarium graminearum* and other *Fusarium* species sampled over wheat plots. *Can. J. Bot.* 78:497-505.

J. Molina Mediavilla, J. Angulo, E. Domínguez, A. Castro, and F. Infante. 1997. Annual and diurnal incidence of *Cladosporium* conidia in the atmosphere of Córdoba, Spain. *J. Investigational Allergology and Clinical Immunology* 7(3):179-182.

²⁵ J.H. Chapman, H. Burge, M. Muilenberg. 1996. Fungus allergen exposure during Midwest USA Fall crop harvests. *J. Allergy Clin. Immun.* 77(1 part 2):200.

²⁶ C.S. Clark, R. Rylander, and L. Larsson. 1983. Levels of gram-negative bacteria, *Aspergillus fumigatus*, dust, and endotoxin at compost plants. *Appl. Environ. Microb.* 45:1501-1505.

²⁷ M. Burch and E. Levetin. 2002. Effects of meteorological conditions on spore plumes. *Int. J. Biometeorol.* 46: 107-117.

O. Carisse and V. Pilon. 2002. Meteorological factors affecting periodicity and concentration of airborne spores of *Bremia lactuceae*. *Can. J. Plant Pathol.* 24:184-193.

²⁸ Molina et al., 1997. See note 24 above.

²⁹ Molina et al., 1997. See note 24 above.

³⁰ M.K. Agarwal, M.C. Swanson, and C.E. Reed. 1983. Immunochemical quantitation of airborne short ragweed, *Alternaria*, antigen

TABLE 3.4 Variability of Spore Concentrations Reported in Various Locations

Analysis	Range	Condition	Locale	Authors
Culture	0-17 cfu/liter ^a	Ambient		Gorny, Reponen et al. ^b
Culture	0-7 cfu/liter	Ambient	Washington, D.C.	Jones and Cookson ^c
Spore count	70-200 spores/liter	Ambient	Oklahoma	Burch and Levetin ^d
Culture	100-1,000/liter	Harvesting	Egypt	Hameed and Khodr ^e
Spore counts	5-26/liter	Yard waste compost	Illinois	Hryhorczuk et al. ^f
Culture	11 (6-3)/liter, winter 5 (2-12)/liter, summer	Ambient	Taiwan	Pei-Chih et al. ^g
Culture	1 cfu/liter	Ambient	Taiwan	Li, Hsu et al. ^h
Counts	>1,000/liter	Crop harvest	Missouri	Chapman, Burge et al. ⁱ
RNA probes	>25 organisms/liter	Ambient peaks	Sweden	Biggins et al. ^j

^a Colony-forming unit, cfu.

^b R.L. Gorny, T. Reponen, K. Willeke, D. Schmechel, E. Robine, M. Boissier, and S.A. Grinshpun. 2002. Fungal fragments as indoor air biocontaminants. *Appl. Environ. Microb.* 68:3522-3531.

^c B.L. Jones and J.T. Cookson. 1983. Natural atmospheric microbial conditions in a typical suburban area. *Appl. Environ. Microb.* 45:919-934.

^d M. Burch and E. Levetin. 2002. Effects of meteorological conditions on spore plumes. *Int. J. Biometeorol.* 46:107-117.

^e A.A. Hameed and M.I. Khodr. 2001. Suspended particulates and bioaerosols emitted from an agricultural nonpoint source. *J. Environ. Monit.* 3:206-209.

^f D. Hryhorczuk, L. Curtis, P. Scheff, J. Chung, M. Rizzo, C. Lewis, N. Keys, and M. Moomey. 2001. Bioaerosol emissions from a suburban yard waste composting facility. *Ann. Agr. Environ. Med.* 8:177-185.

^g W. Pei-Chih, S. Huey-Jen, and L. Chia-Yin. 2000. Characteristics of indoor and outdoor airborne fungi at suburban and urban homes in two seasons. *Sci. Total Environ.* 253:111-118.

^h C.S. Li, C.W. Hsu, and M.L. Tai. 1997. Indoor pollution and sick building syndrome symptoms among workers in day-care centers. *Arch. Environ. Heal.* 52:200-207.

ⁱ J.H. Chapman, H. Burge, M. Muilenberg. 1996. Fungus allergen exposure during Midwest USA Fall crop harvests. *J. Allergy Clin. Immunol.* 77(1 part 2):200.

^j P. Biggins, N. Pomeroy, M. Pearce, C. Stone, N. Brown, R.M. Harrison, J. Hobman, and A. Jones. 2002. Characterisation of the ambient respirable biological aerosol in Proceedings of the Sixth Annual UK Review Meeting on Outdoor and Indoor Air Pollution Research. Available at <http://www.le.ac.uk/ieh/pdf/w12.pdf>. Accessed November 2003. pp. 75-77.

Outdoor Bacteria

Natural outdoor bacterial aerosols are derived from plants, soil, and water. Bacteria are common on or in all of these sources. Every leaf is colonized with a population of bacteria that probably is essential to the healthy life of the plant. Most bacteria are probably released from leaf surfaces, and the primary mechanisms for release are probably droplet splash and wind. Although as yet unmeasured, bacterial clouds released during rainfall are likely to be equivalent to the clouds produced by the fungi. Droplets falling into water create bubbles that scavenge bacteria from the liquid and introduce the cells into the air when the bubbles burst.³¹

E, and Alt-I allergens: A two-year prospective study. *J. Allergy Clin. Immunol.* 72:40-45.

C. Barnes, K. Schreiber, F. Pacheco, J. Landuyt, F. Hu, and J. Portnoy. 2000. Comparison of outdoor allergenic particles and allergen levels. *Ann. Allerg. Asthma Im.* 84:47-54.

³¹ R. Marks, K. Jankowska, M. Michalska, and M. Krolska. 1996. The sea to air bacteria transfer from the coastal waters. *Bull. Inst. Marit. Trop. Med. Gdynia.* 47(1-4):93-103.

C. Gomez-Suarez, H.J. Busscher, and H.C. van der Mei. 2001. Analysis of bacterial detachment from substratum surfaces by the passage of air-liquid interfaces. *Appl. Environ. Microb.* 68:3522-3531.

Disturbance of compost, moldy hay, or other damp organic material will release large numbers of thermophilic bacteria (primarily actinomycetes and *Bacillus* species). Soil is another important source for airborne bacteria and has been considered a source for Q fever in French Guiana.³²

Bacterial Concentrations

Bacterial aerosols vary vertically, geographically, and over time. Meteorological factors such as changing wind direction may play a major role in the characteristics of bacterial populations.³³ Few data are available on bacterial populations in outdoor air, and virtually all that is published is derived from cultural sampling and likely to be a gross underestimate of actual concentrations. Some of the data that are available are presented in Table 3.5.

Biggins et al.³⁴ reported two fungal peaks and three bacterial peaks in excess of 25,000 per cubic meter using counts derived from ribonucleic acid (RNA) probe data. Of the bacteria, 28 percent were unidentified, providing an example of how little is actually known about the outdoor bacterial aerosol. In studies evaluating airborne culturable bacteria in various localities in Sweden, bacterial levels above city streets were highest.³⁵ However, when event-associated aerosol releases occur, rural areas are likely to experience the greatest and fastest releases due to the potential for disturbance of agricultural materials.

Because many of the biological agents of concern are bacteria, it is important to know specifically what kinds of bacteria may be present in air, and whether or not there are natural populations of any of the biological threat agents. *Bacillus* species are especially common in the natural environment. Natural populations of *Bacillus thuringiensis* were recovered from soil in Spain.³⁶ In addition, *B. thuringiensis* is used as an insecticide and is sprayed into the air and allowed to settle on affected plants. At least transiently, concentrations of this organism may be very high.³⁷ Dust generated by combines (harvesters) is also a rich source for *Bacillus* aerosols, including *B. brevis*, *B. cereus*, *B. circulans*, *B. coagulans*, *B. licheniformis*, *B. stearothermophilus*, and *B. subtilis*.³⁸ Bacterial cell wall fragments are probably abundant in outdoor air. These have been measured only as either endotoxin (gram-negative) or peptidoglycan (all bacteria), and measurements have not been correlated with particle counts.

Other Outdoor Bioaerosols

Actual concentrations of viral particles in outdoor air are unknown. However, they have been recovered from plumes above sewage treatment facilities.³⁹ Clearly, transmission of viral disease can occur via transport through outdoor air. Foot and mouth and Newcastle viruses are animal disease agents for which epidemiological data have confirmed outdoor airborne spread. Also, enteric viruses

³² J. Gardon, J.M. Heraud, S. Laventure, A. Ladam, P. Capot, E. Foquet, J. Favre, S. Webber, D. Hommel, A. Hulin, Y. Couratte, and A. Talermin. 2001. Suburban transmission of Q fever in French Guiana: Evidence of a wild reservoir. *J. Infect. Dis.* 184:278-284.

³³ B. Lighthart and A. Kirilenko. 1998. Simulation of summer-time diurnal bacterial dynamics in the atmospheric surface layer. *Atmos. Environ.* 32(14-15):2491-2496.

³⁴ P. Biggins, N. Pomeroy, M. Pearce, C. Stone, N. Brown, R.M Harrison, J. Hobman, and A. Jones. 2002. Characterisation of the ambient respirable biological aerosol in Proceedings of the Sixth Annual UK Review Meeting on Outdoor and Indoor Air Pollution Research. Available at <http://www.le.ac.uk/ieh/pdf/w12.pdf>. Accessed August 2003, pp. 75-77.

³⁵ A. Bovallius, B. Bucht, R. Roffey, and P. Anas. 1978. Three year investigation of the natural airborne bacterial flora at four localities in Sweden. *Appl. Environ. Microb.* 35:847-852.

³⁶ J. Iriarte, Y. Bel, M.D. Ferrandis, R. Andrew, J. Murillo, J. Ferre, and P. Caballero. 1998. Environmental distribution and diversity of *Bacillus thuringiensis* in Spain. *Syst. Appl. Microbiol.* 21:97-106.

³⁷ K. Teschke, Y. Chow, K. Bartlett, A. Ross, and C. van Netten. 2001. Spatial and temporal distribution of airborne *Bacillus thuringiensis* var. *kurstaki* during an aerial spray program for gypsy moth eradication. *Environ. Heal. Persp.* 109:47-54.

³⁸ A.A. Shoreit and M.A. Ismail. 1992. *Bacillus* species associated with wheat and sorghum dusts from combine harvester. *Zentrabl. Mikrobiol.* 147:541-550.

³⁹ E.R. Baylor, M.B. Baylor, D.C. Blanchard, L.D. Syzdek, and C. Appel. 1977. Virus transfer from surf to wind. *Science* 198(4317):575-580.

A. Carducci, C. Gemelli, L. Cantiani, B. Casini, and E. Rovini. 1999. Assessment of microbial parameters as indicators of viral contamination of aerosol from urban sewage treatment plants. *Lett. Appl. Microbiol.* 28:207-210.

TABLE 3.5 Reported Concentrations of Total Bacteria in Outdoor Air

Assay Method	Concentration	Sample Environment	Location	Authors
Culture	0.1-0.6 cfu/liter (24-hr average) ^a	Urban air	Oregon	Shaffer and Lighthart ^b
Culture	0-4 cfu/liter (3-year averages)	Rural and urban air	Sweden	Bovallius, Bucht et al. ^c
Culture	1.4-2.2 cfu/liter	Above waste treatment plant		Brandi, Sisti et al. ^d
Culture	0.09-4.7/liter		Eastern Europe	Gorny, Reponen et al. ^e
Culture	10-1,000/liter	Wheat harvest	Egypt	Hameed and Khodr ^f
Culture	0.5-78.9 cfu/liter	Yard waste compost site	Illinois	Hryhorczuk, Curtis et al. ^g
Culture	0.004-1.5 cfu/liter	Ambient	Washington, D.C.	Jones and Cookson ^h
Culture	10 cfu/liter	Sewage sludge application	Texas	Pillai, Widmer et al. ⁱ
Culture	0.4 cfu/liter	Ambient	Taiwan	Li, Hsu et al. ^j
RNA probes	>25 organisms/liter	Ambient peaks	England	Biggins, Pomeroy et al. ^k

^a Colony-forming unit, cfu.

^b B.T. Shaffer and B. Lighthart. 1997. Survey of culturable airborne bacteria at four diverse locations in Oregon: urban, rural, forest, and coastal. *Microb. Ecol.* 34:167-177.

^c A. Bovallius, B. Bucht, R. Roffey, and P. Anas. 1978. Three year investigation of the natural airborne bacterial flora at four localities in Sweden. *Appl. Environ. Microb.* 35:847-852.

^d G. Brandi, M. Sisti, and G. Amagliani. 2001. Evaluation of the environmental impact of microbial aerosols generated by wastewater treatment plants utilizing different aeration systems. *J. Appl. Microb.* 88:845-852.

^e R.L. Gorny, T. Reponen, K. Willeke, D. Schmechel, E. Robine, M. Boissier, and S.A. Grinshpun. 2002. Fungal fragments as indoor air biocontaminants. *Appl. Environ. Microb.* 68:3522-3531.

^f A.A. Hameed and M.I. Khodr. 2001. Suspended particulates and bioaerosols emitted from an agricultural nonpoint source. *J. Environ. Monit.* 3:206-209.

^g D. Hryhorczuk, L. Curtis, P. Scheff, J. Chung, M. Rizzo, C. Lewis, N. Keys, and M. Moomey. 2001. Bioaerosol emissions from a suburban yard waste composting facility. *Ann. Agr. Environ. Med.* 8:177-185.

^h B.L. Jones and J.T. Cookson. 1983. Natural atmospheric microbial conditions in a typical suburban area. *Appl. Environ. Microb.* 45:919-934.

ⁱ S.D. Pillai, K.W. Widmer, S.E. Dowd, and S.C. Ricke. 1996. Occurrence of airborne bacteria and pathogen indicators during land application of sewage sludge. *Appl. Environ. Microb.* 61:296-299.

^j C.S. Li, C.W. Hsu, and M.L. Tai. 1997. Indoor pollution and sick building syndrome symptoms among workers in day-care centers. *Arch. Envir. Heal.* 52:200-207.

^k P. Biggins, N. Pomeroy, M. Pearce, C. Stone, N. Brown, R.M. Harrison, J. Hobman, and A. Jones. 2002. Characterisation of the ambient respirable biological aerosol. In *Proceedings of the Sixth Annual UK Review Meeting on Outdoor and Indoor Air Pollution Research*. Available at <http://www.le.ac.uk/ieh/pdf/w12.pdf>. Accessed November 2003. pp. 75-77.

have been recovered from the surf zone near where the Hudson River discharges into the Atlantic, and nearby residents have a higher than expected rate of disease related to these organisms.⁴⁰

Indoor Aerosols

Common sources for indoor bioaerosols are listed in Table 3.6. In naturally ventilated interiors, the outdoor aerosols strongly affect indoor air, especially during seasons with open windows (see below). Understanding variations in the outdoor aerosol for all relevant particles is essential to predicting

⁴⁰ Baylor et al., 1977. See note 39 above.

TABLE 3.6 Overview of Sources for Indoor Bioaerosols

Aerosol Particle	Source Organism ^a	Environmental Source	Aerosolization Mechanism
Virus droplet nucleus	NA	Human or animal occupants Toilets	Cough, sneeze, other respiratory Toilet flushing Bursting bubbles Surf action
Bacterium in droplet nucleus	NA	Human or animal occupants Toilets Humidifiers, cooling coils, drip trays Fountains, fish tanks Soil	Cough, sneeze, other respiratory Toilet flushing Action of humidifier Droplet splash; bubbling Dust disturbance
Bacterium on raft	NA	Outdoor air; human or animal occupants Dust	Skin shedding activities; dust raising activities
Bacterial spore; bacterial fragments	Bacterium	Outdoor air; human or animal occupant Surface and carpet dust Water reservoirs (humidifiers, fountains, fish tanks, etc.)	Human or animal activities; sweeping, vacuum cleaning; bellows action on soft furniture Disturbance of water; action of humidifiers, fountains, bubblers, etc.
Algae	NA	Outdoor air; water reservoirs (fountains, fish tanks)	Disturbance of water reservoirs; bubbles
Pollen and other plant parts	Plants	Outdoor air; dust; house plants	Disturbance of house plants
Dust mite fecal ball	Dust mites	Dust	Bed making, vacuuming, bellows effects from pillows and soft furniture
Other arthropod components	Cockroaches, spiders, mites	Dust, surfaces	Disturbance of dust (babies crawling, vacuuming, sweeping)
Animal allergens	Cats, dogs, mice, etc.	The animal; dust on surfaces, in carpeting, furniture, clothing	Activity of the animal; disturbance of dust
Fungal spores	Fungal colonies	Outdoor air; surface growth; growth in materials and water reservoirs; dust	Changes in humidity (active discharge mechanisms); air currents; disturbance of growth; disturbance of dust
Fungal hyphae; fungal metabolites	Fungal colonies	Growth in materials, on surfaces	Active disturbance of growth

^a NA, not applicable.

concentrations indoors. Although most available data focus on pollen and fungal spores, bacterial levels outdoors are likely to be extremely important as well.

Indoors, the most consistently important source for bioaerosols is human occupants. This is the primary source for viral aerosols and a major source for bacteria. People also shed outdoor-source particles that transiently affect indoor concentrations.

Aerosols that are primarily derived from indoor sources include arthropod, pet, and pest dander and bacterial and fungal aerosols that are released from active environmental growth. These aerosols generally are released by air currents, action of appliances (e.g., humidifiers), and mechanical disturbances (e.g., vacuuming, scrubbing). A contaminated cool mist humidifier can introduce millions of

bacteria and fungi per minute into the air.⁴¹ Ultrasonic units may kill these organisms, but fragments are still aerosolized. Vacuuming with ordinary brush and beater vacuums equipped with ordinary bags can raise clouds of dust with entrained organic material and microorganisms.⁴² However, some studies have reported no association between vacuuming and airborne dust levels.⁴³

Indoor Pollen and Pollen-Derived Particles

One study has evaluated particle penetration into moving vehicles using ragweed pollen as an indicator.⁴⁴ Another evaluated the effects of room air conditioners on indoor pollen concentrations.⁴⁵ In both of these, there was a direct correlation between indoor and outdoor counts, with the indoor/outdoor ratio being related to whether or not windows were open. Similarly, allergen measurements in floor dust reveal a close correlation between specific pollen allergen concentrations and outdoor pollen counts.

Probably most pollen enters the air directly from outdoors. However, it is also likely that pollen grains are captured by people and by animals and brought inside. These would be re-released during activities of those carrying them. Because pollen grains are large and fall rapidly, these aerosols are transient.

Pollen Concentrations

Except for studies of penetration and accumulation in dust from outdoors, indoor pollen concentrations have not been systematically studied. In fact, indoor sources of pollen are uncommon. Most plants grown indoors (except in specialized environments such as greenhouses) do not produce airborne pollen. Measured pollen levels in occupied spaces have almost always been reported as less than those outside, with the difference depending on pathways for penetration.⁴⁶ No study has reported indoor levels that exceed those outdoors, and indoor levels are generally low (less than 1 grain per liter).

Floor dust analysis is the method most commonly used to measure indoor allergens, including pollen. In Sweden, outdoor birch pollen peaks in May range from 80 to 140 grains per cubic meter, and indoor allergen concentration closely parallels outdoor pollen counts.⁴⁷ Fahlbusch et al.⁴⁸ measured 120 to 150 nanograms grass pollen allergen per square meter of carpet. Maximum levels ranged from 4,000 to 6,000 nanograms per square meter. Allergen concentrations were highest during pollen season and correlated reasonably well with pollen counts. Neither concentrations of airborne allergen nor concentrations of allergen-bearing particles have been reported for pollen.

Indoor Fungi

Indoor/outdoor relationships for fungal spores are complex and depend on the type of spore under consideration.⁴⁹ Some fungi are rarely found growing indoors (i.e., most basidiomycetes), while others

⁴¹ W.R. Solomon. 1976. A volumetric study of winter fungus prevalence in the air of Midwestern homes. *J. Allergy Clin. Immun.* 57:46-55.

R.L. Haddock and F.A. Nocon. 1994. Infant salmonellosis and vacuum cleaners. *J. Trop. Pediatrics* 40:53-54.

⁴² Haddock and Nocon, 1994. See note 41 above.

⁴³ L. Lehtonen and P. Huovinen. 1993. Susceptibility of respiratory tract pathogens in Finland to cefixime and nine other antimicrobial agents. *Scand. J. Infect. Dis.* 25:373-378.

⁴⁴ M.L. Muilenberg, W.S. Skellenger, H.A. Burge, and W.R. Solomon. 1991. Particle penetration into the automotive interior I. Influence of vehicle speed and ventilatory mode. *J. Allergy Clin. Immun.* 87:581-585.

⁴⁵ W.R. Solomon, H.A. Burge, and J.R. Boise. 1980. Exclusion of particulate allergens by window air conditioners. *J. Allergy Clin. Immun.* 64:305-308.

⁴⁶ D.A. Sterling and R.D. Lewis. 1998. Pollen and fungal spores indoor and outdoor of mobile homes. *Ann. Allergy Asthma Immun.* 80:279-285.

⁴⁷ L. Holmquist, J. Weiner, and O. Vesterberg. 2001. Airborne birch and grass pollen allergens in street-level shops. *Indoor Air* 11:241-245.

⁴⁸ B. Fahlbusch, D. Horning, J. Heinrich, and L. Jager. 2001. Predictors of group 5 grass-pollen allergens in settled house dust: Comparison between pollination and nonpollination seasons. *Allergy* 56:1081-1086.

⁴⁹ D. Li and B. Kendrick. 1996. Functional and causal relationships between indoor and outdoor airborne fungi. *Can. J. Bot.* 74:194-

may become abundant indoors (e.g., *Aspergillus* and *Penicillium* species). However, most indoor fungi are derived directly from outdoor air and hence are present in lower concentrations indoors than outdoors.⁵⁰ Penetration depends, as for pollen, on existing pathways into the building. Central ventilation system filtration plays some role in determining the size of the pathways although even with low-efficiency filtration, in large buildings most fungal spores do not travel all the way through the ventilation system to reach the occupied space.

Indoor/outdoor ratios are often used as an indicator for whether or not an indoor space is supporting fungal growth. However, this ratio is strongly dependent on the concentration of spores outdoors, with low outdoor spore counts often leading to ratios greater than 1 in the absence of active growth.⁵¹

Activities strongly influence concentrations of fungal spores in indoor air. Any activity that disturbs a source is likely to increase levels. Some activities considered important are cleaning, bed making, etc.⁵²

Scheff et al.⁵³ calculated the rate of shedding of fungi from people in a building based on number of occupants, activity, and the number of fungi recovered from air during activity. This group estimated the release of 167 cfu per hour per person for total fungi. Fungi also actively release spores, primarily during changes in water activity. Thus, large peaks of spores may be released if the temperature in a room drops, causing the relative humidity to rise (at least locally) and condensation to occur.

Indoor spore concentrations represent the sum of outdoor penetration and release from indoor reservoirs such as dust or active growth in one or more reservoirs. The largest spore clouds result from disturbance of active growth or, in some cases, from forcible spore discharge in such growth. Table 3.7 lists a few studies that report indoor spore levels. The concentrations presented in Table 3.7 are biased by the analytical method used, and all underestimate true particle concentrations, as discussed above. Some evidence exists for small particle aerosols of fungal allergens in the 1 to 5 μm range.⁵⁴ However, this is an area that needs additional work.

Indoor Bacteria

Source/Release Factors

As they did for fungi, Scheff et al.⁵⁵ have estimated the number of bacteria released by people. They estimate 227 cfu/hr/person-min. Unlike fungi, which are shed primarily from clothing, most bacteria are commensal organisms and are shed from skin surfaces and expired with respiratory secretions. Skin surface organisms are released with physical activity and are abundant in schools for this reason. Respiratory organisms are released with sneezes, coughs, and, to a lesser extent, with singing and speaking. Bacteria from humans may become airborne either as droplet nuclei or on skin or fiber rafts. Droplet nuclei can be nearly as small as an individual bacterium and may stay airborne for many minutes. Rafts are usually much larger and probably fall within only a few minutes. These factors have not been studied sufficiently to allow predictions of the extent to which these aerosols might interfere with agent detection.

209.

⁵⁰ H.A. Burge, D.L. Pierson, T.O. Groves, K.F. Strawn, and S.K. Mishra. 2000. Dynamics of airborne fungal populations in a large office building. *Curr. Microbiol.* 40:10-16.

⁵¹ Burge et al., 2000. See note 50 above.

⁵² M. Lehtonen, T. Reponen, and A. Nevalainen. 2003. Everyday activities and variation of fungal spore concentrations in indoor air. *Int. Biodeter. Biodegr.* 31:25-39.

⁵³ P.A. Scheff, V.K. Paulius, L. Curtis, and L.M. Conroy. 2000. Indoor air quality in a middle school, Part II: Development of emission factors for particulate matter and bioaerosols. *Appl. Occup. Environ. Hyg.* 15:835-842.

⁵⁴ M.Y. Menetrez, K.K. Foarde, and D.S. Ensor. 2001. An analytical method for the measurement of nonviable bioaerosols. *J. Air Waste Manage.* 51: 1436-1442.

⁵⁵ Scheff et al., 2000. See note 53 above.

TABLE 3.7 Sample Concentrations of Fungal Spores in Indoor Environments

Analytic Method	Concentration	Condition	Locale	Authors
Culture	1-2 cfu/liter ^a	University auditorium	Italy	Sessa, Di Pietro et al. ^b
Culture	0.1-0.3 cfu/liter	Apartment	Italy	Sessa, Di Pietro et al. ^b
Direct microscopy	5-11 org./liter ^c	Large buildings	U.S. Midwest	Reynolds, Black et al. ^d
Culture	9 (4-18) cfu/liter winter 4 (2-12) cfu/liter summer	Residences	Taiwan	Pei-Chih, Huey-Jen et al. ^e
Culture	0.9 (0.5-3) cfu/liter	Apartments	France	Duchaine and Meriaux ^f
Culture	0 to 41 cfu/liter	Residences	Scotland	Strachan, Flannigan et al. ^g
Culture	0.01 to >20 cfu/liter	Residences	U.S. Northeast	Solomon ^h
Culture	0.846-1.033 cfu/liter	Residences	U.S. Northeast	Ren, Jankun et al. ⁱ
Culture	0.2-0.8 cfu/liter	Homes, offices	Poland	Lis, Pastuszka et al. ^j
Culture	1 (2-12) cfu/liter	Day care centers	Taiwan	Li and Hsu ^k
Culture	1-200 cfu/liter	During office remediation	Finland	Rautiala, Reponen et al. ^l
Spore count	100-1,000 spores/liter	During office remediation	Finland	Rautiala, Reponen et al. ^l
Culture	0-17 cfu/liter	Residences	Poland	Gorny, Reponen et al. ^m
Culture	5 cfu/liter ⁿ	Residences	Poland	Gorny, Reponen et al. ^m

^a Colony-forming units, cfu.

^b R. Sessa, M. Di Pietro, G. Schiavoni, I. Santino, A. Altieri, S. Pinelli, and M. Del Piano. 2002. Microbiological indoor air quality in healthy buildings. *New Microbiol.* 25:51-56.

^c Combination of directly counted individual bacterial and fungal cells.

^d S.J. Reynolds, D.W. Black, S.S. Borin, G. Breuer, L.F. Burmeister, L.F. Guortes, T.F. Smith, M.A. Stein, P. Subramanian, P.S. Thorns, and P. Whitten. 2000. Indoor environmental quality in six commercial office buildings in the Midwest United States. *Appl. Occup. Environ. Hyg.* 16:1065-1077.

^e W. Pei-Chih, S. Huey-Jen, and L. Chia-Yin. 2000. Characteristics of indoor and outdoor airborne fungi at suburban and urban homes in two seasons. *Sci. Total Envir.* 253:111-118.

^f C. Duchaine and A. Meriaux. 2000. Airborne microfungi from eastern Canada sawmills. *Can. J. Microb.* 46:612-617.

^g D.P. Strachen, B. Flannigan, E.M. McCabe, and F. McGarry. 1990. Quantification of airborne moulds in the homes of children with and without wheeze. *Thorax* 45:382-387.

^h W.R. Solomon. 1976. A volumetric study of winter fungus prevalence in the air of Midwestern homes. *J. Allergy Clin. Immun.* 57:46-55.

ⁱ P. Ren, T.M. Jankun, K. Belanger, M.B. Bracken, and B.P. Leaderer. 2001. The relation between fungal propagules in indoor air and home characteristics. *Allergy* 56:419-424.

^j D.O. Lis, J.S. Pastuszka, and R.L. Gorny. 1997. [The prevalence of bacterial and fungal aerosol in homes, offices and ambient air of Upper Silesia. Preliminary results.] *Rocz. Panstw. Zakl. Hig.* 48:59-68.

^k C.S. Li, C.W. Hsu, and M.L. Tai. 1997. Indoor pollution and sick building syndrome symptoms among workers in day-care centers. *Archive of Environmental Health* 52:200-207.

^l S. Rautiala, T. Reponen, A. Hyvärinen, A. Nevalainen, T. Husman, A. Vehviläinen, and P. Kalliokoski. 1996. Exposure to airborne microbes during the repair of moldy buildings. *Am. Ind. Hyg. Assoc. J.* 57:279-284.

^m R.L. Gorny, T. Reponen, K. Willeke, D. Schmechel, E. Robine, M. Boissier, and S.A. Grinshpun. 2002. Fungal fragments as indoor air biocontaminants. *Appl. Environ. Microb.* 68:3522-3531.

ⁿ Exposure limit.

Indoor Bacterial Concentrations

Reported concentrations of bacteria in indoor air are listed in Table 3.8. Again, results are biased due to the method of analysis, and total concentrations far exceed those represented by culture (see discussion above).

Bacterial products may be present in aerosols not associated with intact bacterial cells. Endotoxin is a prime example. Although endotoxin clearly is consistently present in both outdoor and indoor air and (especially indoors) can reach concentrations that impact human health, studies documenting the actual particles on which the endotoxin is borne have not been conducted. Most is probably present on intact gram-negative bacteria. Office building levels are usually relatively low (between 0.05 and 3 nanograms per liter), with naturally ventilated building levels lower than levels in mechanically ventilated ones.^{56,57} On the other hand, in areas where agricultural and animal confinement activities are occurring, levels are often much higher (e.g., 490 nanograms per cubic meter for swine confinement).⁵⁸

TABLE 3.8 Reported Concentrations of Bacteria in Indoor Air in Various Circumstances

Analysis Method	Concentration	Type of Building	Location	Authors
Culture	0.9-1.2 cfu/liter	Auditorium with people	Rome	Sessa, Di Pietro, et al. ^a
Culture	0.735 cfu/liter	Day care centers	Taiwan	Li, Hsu et al. ^b
Culture	8-11org/liter ^c	Office buildings	U.S. Midwest	Reynolds, Black et al. ^d
Culture	425 (167-930) cfu/liter	Swine confinement	Canada	Duchaine, Grimard et al. ^e
Culture	57-260 cfu/m ³	Homes	Poland	Lis, Pastuszka et al. ^f
Culture	19-118 cfu/m ³	Offices	Poland	Lis, Pastuszka et al. ^f
Culture	0-0.196 cfu/liter	Offices	Mauritius	Bholah and Subratty ^g
Culture	0.088-16 cfu/liter	Residences	Poland	Gorny, Reponen, et al. ^h
Culture	5 cfu/liter ⁱ	Residences	Poland	Gorny, Reponen et al. ^h

^a R. Sessa, M. Di Pietro, G. Schiavoni, I. Santino, A. Altieri, S. Pinelli, and M. Del Piano. 2002. Microbiological indoor air quality in healthy buildings. *New Microbiol.* 25:51-56.

^b C.S. Li, C.W. Hsu, and M.L. Tai. 1997. Indoor pollution and sick building syndrome symptoms among workers in day-care centers. *Archives of Environmental Health* 52:200-207.

^c Combination of directly counted individual bacterial and fungal cells.

^d S.J. Reynolds, D.W. Black, S.S. Borin, G. Breuer, L.F. Burmeister, L.F. Guortes, T.F. Smith, M.A. Stein, P. Subramanian, P.S. Thorns, and P. Whitten. 2000. Indoor environmental quality in six commercial office buildings in the Midwest United States. *Appl. Occup. Environ. Hyg.* 16:1065-1077.

^e C. Duchaine, Y. Grimard, and Y. Cormier. 2000. Influence of building maintenance, environmental factors, and seasons on airborne contaminants of swine confinement buildings. *Am. Ind. Hygiene Assn J.* 61:56-63.

^f D.O. Lis, J.S. Pastuszka, and R.L. Gorny. 1997. [The prevalence of bacterial and fungal aerosol in homes, offices and ambient air of Upper Silesia. Preliminary results.] *Rocz. Panstw. Zakl. Hig.* 48:59-68.

^g R. Bholah and A.H. Subratty. 2002. Indoor biological contaminants and symptoms of sick building syndrome in office buildings in Mauritius. *Int. J. Environ. Heal. Res.* 12:93-98.

^h R.L. Gorny, T. Reponen, K. Willeke, D. Schmechel, E. Robine, M. Boissier, and S.A. Grinshpun. 2002. Fungal fragments as indoor air biocontaminants. *Appl. Environ. Microb.* 68:3522-3531.

ⁱ exposure limit

⁵⁶ K.B. Teeuw, C.M. Vanderbroucke-Grauls, and J. Verhoef. 1994. Airborne gram-negative bacteria and endotoxin in sick building syndrome: A study in Dutch governmental office buildings. *Arch. Intern. Med.* 154:2339-2345.

⁵⁷ S.J. Reynolds, D.W. Black, S.S. Borin, G. Breuer, L.F. Burmeister, L.F. Guortes, T.F. Smith, M.A. Stein, P. Subramanian, P.S. Thorns, and P. Whitten. 2000. Indoor environmental quality in six commercial office buildings in the Midwest United States. *Appl. Occup. Environ. Hyg.* 16:1065-1077.

⁵⁸ C. Duchaine, Y. Grimard, and Y. Cormier. 2000. Influence of building maintenance, environmental factors, and seasons on airborne contaminants of swine confinement buildings. *American Industrial Hygiene Association Journal* 61:56-63.

Other Bioaerosols

Many other bioaerosols occur in indoor environments, although most are probably present in concentrations too low to be a problem with respect to false alarms. However, cat and dog allergens (proteins associated with particles ranging from smaller than 1 μm to larger than 20 μm ⁵⁹) could be present in sufficient concentration in homes with these animals to trigger detectors that rely on protein fluorescence.⁶⁰ The same is likely to be true for other animals, especially rodents kept in animal care facilities associated with research buildings or hospitals.

With respect to bioagent detection, natural indoor aerosols may trigger false alarms unless the detectors and their analytic methods have a means for controlling this source of error. Because, in general, the types of aerosols that are natural in indoor air are different from those likely to be associated with biological attacks, some level of particle identification may solve this problem. The specificity of identification necessary depends on the specific types of aerosols actually found to be common in indoor air and the relationships between these organisms and the bioagents of concern. Determining these parameters will require measurement of indoor aerosols using new methods of detection, and then empirically determining the level of specificity needed to prevent excessive false alarms.

Predicting the Prevalence of Bioaerosols

Understanding the prevalence of biological aerosols requires consideration of all the factors in Table 3.9. It is impossible to map all aerosol concentrations, and predictions are essential to allow extrapolation from relatively limited collected data. If one can document the effects of each of these variables, predictive models could be developed so that extensive sampling becomes less necessary (other than to test the reliability of the models).

A number of groups have published models intended to predict pollen and spore concentrations. These models fall into four general categories:

- Prediction of long-term trends—for example, trends associated with global warming;
- Prediction of the severity of coming seasons;
- Prediction of the start date for future seasons; and
- Prediction of concentrations for the following day.

Predictive models are currently being used to study the effects of global warming. In general, pollen and spore concentrations are expected to gradually rise in response to warmer temperatures and higher levels of CO_2 .⁶¹ Both pollen and fungal spores are produced in greater abundance as CO_2 levels increase in their environment.⁶²

Emberlin et al.⁶³ evaluated long-term changes in pollen concentrations as possible causes for the increasing prevalence of hay fever symptoms. Land use changes, cumulative temperature, and rainfall were used as predictors for the severity of coming seasons in a single-equation multivariate model that resulted in greater than 95 percent predictive value. Galan et al.⁶⁴ also used weather variables in a

⁵⁹ L. Holmquist and O. Vesterberg. 2002. Direct on air sampling filter quantification of cat allergen. *J. Biochem. Bioph. Meth.* 51:17-25.

H. Ormstad and M. Lovik. 2002. Air pollution, asthma and allergy—the importance of different types of particles. *Tidsskr. Nor. Laegeforen* 122:1777-1782.

⁶⁰ H. Ormstad. 2000. Suspended particulate matter in indoor air adjuvants and allergen carriers. *Toxicology* 152:52-68.

⁶¹ C.P. Osborne, I. Chuine, D. Viner, and F.I. Woodward. 2000. Olive phenology as a sensitive indicator of future climatic warming in the Mediterranean. *Plant, Cell and Environment* 23:701-710.

⁶² J.N. Klironomos, M.C. Rillig, M.F. Allen, D.R. Zak, M. Kubiske, and K.S. Pregitzer. 1997. Increased levels of airborne fungal spores in response to populus tremuloides grown under elevated atmospheric CO_2 . *Can. J. Bot.* 75:1670-1673.

⁶³ J. Emberlin, J. Mullins, J. Corden, S. Jones, W. Millington, M. Brooke, and M. Savage. 1999. Regional variations in grass pollen seasons in the UK: Long-term trends and forecast models. *Clin. Exp. Allergy* 29(3):347-356.

⁶⁴ C. Galan, P. Carinanos, H. Garcia-Mazo, P. Alcazar, and E. Dominguez-Vilches. 2001. Model for forecasting *Olea europaea* L. airborne pollen in south-west Andalusia Spain. *Int. J. Biometeorol.* 45:59-63.

TABLE 3.9 Important Factors in Bioaerosol Predictive Models, with Examples

Source Characteristics	Release Mechanisms	Dispersion	Decay
Physical nature of source (single living organism; pond filled with organisms)	Inherent to the organism (forcible spore discharge in fungi)	Air movement rates and patterns (wind speed and direction, including pattern of changes, turbulence)	Particle size factors (settling, impaction, diffusion)
Components of populations (single organism, multiple organisms, fragments)	Inherent to the source (dispersal bombs, spray humidifiers)	Space characteristics (shape and size, connections to other spaces)	Impaction surfaces Dilution (amount of clean air available for dilution)
Concentrations of populations (concentrations of total or individual particles)	External factors (e.g., air movement, water splash and bubbles; abrasion)		Chemical and biological changes (death of infectious particles; denaturing of allergens)
Patterns of variability over time			

multivariate model to predict total output of pollen (i.e., severity of the season) with good success. However, predicting maxima has been less reliable in this instance and others.⁶⁵ Threshold temperatures and mean heat accumulation have been used to predict the start of the pollen season.^{66,67,68} Predictions of next-day counts also have used meteorological parameters, but it is necessary to add variables to account for seasonality and other effects on flowering and pollen release.⁶⁹ Because of the seasonality of pollen production, flowering time predictions are an important aspect of day-to-day pollen predictive modeling.

Local conditions that affect pollen distribution (as well as other bioaerosols) also need to be considered. For example, sea-land breezes play a role in regionally distributing pollen (and probably other local bioaerosols).⁷⁰ Another important set of pollen prediction parameters is endogenous to the plant. Consideration of possible pathogen effects is also important.⁷¹

One group has used neural networks, chaos theory, and fractals to develop pollen predictive models.⁷² Spore models have also been constructed, especially to predict prevalence of plant pathogens, which reach local concentrations in excess of 100 per liter.⁷³ Factors intrinsic to the fungi (i.e., life cycle

⁶⁵ S. Kawashima and Y. Takahashi. 1999. An improved simulation of mesoscale dispersion of airborne cedar pollen using a flowering-time map. *Grana* 38(5):316-324.

⁶⁶ H. Garcia-Mozo, C. Galan, M.J. Aira, J. Belemonte, C. Diaz de la Guardia, D. Fernandez, A.M. Gutierrez, F.J. Rodriguez, M.M. Trigo, and E. Dominguez-Vilches. 2002. Modelling start of oak pollen season in different climactic zones in Spain. *Agr. Forest Meteorol.* 110:247-257.

⁶⁷ J.M. Corden, A. Stach, and W.M. Millington. 2002. A comparison of *Betula* pollen seasons at two European Sites: Derby, United Kingdom, and Poznan, Poland (1995-1999). *Aerobiologia* 18:45-53.

⁶⁸ H. Garcia-Mozo, C. Galán, M.T. Gómez-Casero, and E. Dominguez. 2000. A comparative study of different temperature accumulation methods for predicting the *Quercus* pollen season start in Córdoba (Southwest Spain). *Grana* 39:194-199.

⁶⁹ P.C. Stark, L.M. Ryan, J.L. McDonald, and H.A. Burge. 1997. Using meteorologic data to predict daily ragweed pollen levels. *Aerobiologia* 13: 177-184.

⁷⁰ J. Gassman, C.F. Perez, and J.M. Gardion. 2002. Sea-land breeze in a coastal city and its effect on pollutant transport. *Int. J. Biometeorol.* 46:118-125.

P.V.d. Water and E. Levetin. 2001. Contribution of upwind pollen sources to the characterization of *Juniperus ashei* phenology. *Grana* 40: 133-141.

⁷¹ M. Forenaciai, L. Pieroni, F. Orlandi, and B. Romano. 2002. A new approach to consider the pollen variable in forecasting yield models. *Econ. Bot.* 56(1):66-72.

⁷² M.E. Degaudenzi and C.M. Arizmendi. 1999. Wavelet-based fractal analysis of airborne pollen. *Phys. Rev. E* 59(6):6569-6573
C.M. Arizmendi, J.R. Sanchez, N.E. Ramos, and C.I. Ramos. 1993. Time series predictions with neural nets: Application to airborne pollen forecasting. *Int. J. Biometeorol.* 37:139-144.

⁷³ O. Carisse and V. Pillion. 2002. Meteorological factors affecting periodicity and concentration of airborne spores of *Bremia lactucea*. *Can. J. Plant. Pathol.* 24(2):184-193.

J. Angulo-Romero, A. Mediavilla-Molina, and E. Dominguez-Vilches. 1999. Conidia of *Alternaria* in the atmosphere of the city of

seasonality, spore release mechanisms) are especially important in fungal aerosol models, as are meteorological parameters.

Unfortunately, the kind of model that would be useful for developing background information for sensing bioagents has not been developed. Needless to say, any useful model would have to be specific as to particle type and geography, and would have to have a resolution similar to that of the sensors. The question arises as to whether or not modeling will ever replace sampling for estimation of the chances of false alarms by specific bioaerosol detectors. The answer, of course, depends on the acceptable alarm rate and on the accuracy of the model predictions. Until models have been attempted that directly address this question, we will not know. Certainly, short of empirically determining how reliable sensors are in many background situations, exploration of models seems a cost-effective approach.

CONTROL OF BIOAEROSOLS

Air Cleaning

Air cleaning is the primary approach used in large buildings and is also marketed as a pollution control device for small buildings, residences, and schools. Filtration is by far the most common approach to air cleaning. While centrally installed air cleaning systems have proven efficacious in reducing indoor aerosols, room-sized units have not. Room-sized units tend to be either noisy (so that occupants turn them off) or relatively inefficient.⁷⁴

Filtration

Properly used, filtration can reduce some microbial aerosols to virtually unmeasurable concentrations. Among the tested aerosols are fungal spores,⁷⁵ tuberculosis bacilli,⁷⁶ and a mouse virus.⁷⁷ The last study mentioned used two medium-efficiency filters one after the other and demonstrated essentially a zero disease transmission rate in equipped units. Filtration efficiency does not necessarily depend on the efficiency of filters.⁷⁸

Filtration efficiency is controlled by the pore size of the filter material, whether it is wet or dry, and how securely the filter is installed (i.e., what fraction of the total airstream actually passes through the filter).⁷⁹ Many studies using actual ventilation systems have achieved less than 100 percent reduction even though the filters themselves were capable of 100 percent capture of bioaerosols, indicating that leakage can be a significant problem.⁸⁰ While theoretically filtration could provide absolute protection, practically speaking, gaps and other openings in mechanical systems allow some penetration of aerosols. This effect has not been carefully studied in ordinary buildings.

While standard new HVAC filters can remove considerable percentages of bacteria and fungi from outdoor air, wet, humid conditions may lead to bacterial growth and subsequent release into the building air.⁸¹ This effect has also been documented in a laboratory setting.⁸²

Cordoba, Spain in relation to meteorological parameters. *Int. J. Biometeorol.* 43:45-49.

⁷⁴ Holmquist et al., 2001. See note 47 above.

⁷⁵ R.L. Jacobs and C.P. Andrews. 1989. Hypersensitivity pneumonitis treated with an electrostatic dust filter. *Ann. Intern. Med.* 110:115-118.

⁷⁶ R.L. Marier and T. Nelson. 1993. A ventilation-filtration unit for respiratory isolation. *Infect. Cont. Hosp. Ep.* 14:700-705.

⁷⁷ M. Mrozek, U. Zillmann, W. Nicklas, V. Kraft, B. Meyer, E. Sickel, B. Lehr, and A. Wetzel. 1994. Efficiency of air filter sets for the prevention of airborne infections in laboratory animal houses. *Lab Animal* 28:347-354.

⁷⁸ S.C. Miller-Leiden, C. Lobascio, W.W. Nazaroff, and J.M. Macher. 1996. Effectiveness of in-room air filtration and dilution ventilation for tuberculosis infection control. *J. Air Waste Manage.* 46:869-882.

⁷⁹ F.S. Rhame. 1991. Prevention of noncomial aspergillosis. *J. Hosp. Infect.* 18(Suppl. A):466-472.

⁸⁰ C. Cundith, C. Kerth, W.R. Jones, T.A. McCaskey, and D.L. Kuhlens. 2002. Microbial reduction efficiencies of filtration, electrostatic polarization, and UV components of a germicidal air cleaning system. *J. Food Sci.* 67:2278-2281.

⁸¹ M. Moritz, H. Peters, B. Nipko, and H. Ruden. 2001. Capability of air filters to retain airborne bacteria and molds in heating, ventilating, and air conditioning (HVAC) systems. *Int. J. Envir. Heal.* 203:401-409.

Electrostatic Precipitation

Electrostatic precipitation has long been considered one of the best approaches to air cleaning, especially for residential environments. One case report documents a significant reduction in aerosols of *Aspergillus* spores (2-4 μm) and improvement in symptoms of hypersensitivity pneumonitis using electrostatic precipitators in the return duct of a home.⁸³

Air Treatment

Ultraviolet Light

Ultraviolet light can damage or kill many microorganisms, although the kill rate is rarely 100 percent. Gram-negative bacteria are especially sensitive to ultraviolet light, while acid-fast organisms and spores are very resistant.⁸⁴ A combination of filtration and intensive ultraviolet light reduced bacterial aerosols by 90 to 92 percent, an insufficient reduction to protect fully from large bioagent releases⁸⁵ but still providing a useful mitigation. The change in ultraviolet energy susceptibility of bacteria due to ambient humidity and the phenomenon of photoreactivation also should be considered when attempting to control airborne bacteria using ultraviolet light. Both humidity and visible light protect cells from ultraviolet light-induced damage.⁸⁶ Installed ultraviolet light sources in central ventilation systems can keep surfaces free of microbial growth and may significantly reduce viability in deposited organisms (including resistant ones) over time.⁸⁷

Steam Condensation

Steam condensation has been used to clear aerosols from occupied spaces and could be an approach for increasing the rate of clearance in rooms in which releases have occurred.⁸⁸

Local Exhaust

Remediation of fungal contamination in large buildings is generally done under local exhaust ventilation. Done properly, this approach essentially prevents the spread of contamination outside the containment unit. This approach could be used for rooms where releases have occurred if a facility for exhausting air is in place.

Reservoir Removal

Generally, the first step in remediating any interior contaminated with fungi and/or bacteria is to remove all reservoirs of the organism. For biowarfare agents, this may mean removing carpeting, vacuuming then washing all surfaces, and disinfecting the space.⁸⁹ Carpet is particularly a problem since one of its intended purposes is to trap dirt and make it invisible. Organisms are more likely to accumulate

⁸² P.C. Kemp, H.G. Neumeister-Kemp, G. Lysek and F. Murray. 2001. Survival and growth of micro-organisms on air filtration media during initial loading. *Atmos. Environ.* 35:4739-4749.

⁸³ R.L. Jacobs and C.P. Andrews. 1989. Hypersensitivity pneumonitis treated with an electrostatic dust filter. *Ann. Intern. Med.* 110:115-118.

⁸⁴ S. Miller and J. Macher. 2000. Evaluation of a methodology for quantifying the effect of room air ultraviolet germicidal irradiation on airborne bacteria. *Aerosol Science and Technology* 33:274-295.

⁸⁵ Cundith et al., 2002. See note 80 above.

⁸⁶ J. Peccia and M. Hernandez. 2001. Photoreactivation in airborne *Mycobacterium parafortitutum*. *Appl. Environ. Microbiol.* 67:4225-4232.

⁸⁷ D. Menzies, J. Pasztor, T. Rand, and J. Bourbeau. 1999. Germicidal ultraviolet irradiation in air conditioning systems: Effect on office worker health and well being: A pilot study. *Occup. Environ. Med.* 56:397-402.

⁸⁸ J.H. Edwards, D.M. Trotman, and O.F. Mason. 1985. Methods for reducing particle concentrations of *Aspergillus fumigatus* conidia and mouldy hay dust. *Sabouraudia* 23(4):237-243.

⁸⁹ Paraformaldehyde or chlorine dioxide may be used as disinfectants.

and survive in carpeting than on bare floors. In high-risk environments, it may be appropriate to replace carpeting with hard surface flooring and install a mechanism for fast local exhaust to prevent spread of released microorganisms.

Applicability for Controlling Releases

Good filtration will lessen the impact of building releases, providing systems are properly designed and installed and air exchange rates are high. Obviously, all return air must go through filters if releases within the occupied space are to be controlled. HEPA filtration is not necessary to reduce aerosol concentrations significantly. Viruses, in particular, are often considered to be able to pass through most filter media. This assumption is based on the name "filterable viruses," which refers to the fact that viruses in liquid will pass through very fine filters (even some HEPA filters). However, in aerosol form, viruses are unlikely to be in the form of single virions, and dry filters are far more efficient than wet ones at capturing small particles.

While electrostatic precipitation is considered a method of choice for preventing intrusion of outdoor particles, particle collection efficiencies are not likely to be high enough to reduce agent aerosols to a nonhazardous level.

FINDINGS AND RECOMMENDATIONS

Consistent with the organization of this chapter, the committee offers findings and recommendations related to either the outdoor or indoor backgrounds, as well as the types of organisms potentially present in background bioaerosols.

Outdoor Aerosols

Finding 3-1: Pollen concentrations are apparently low relative to the large bioagent releases that are likely outdoors. However, pollen concentrations are well known only as 24-hour averages and from relatively elevated sites (i.e., tops of buildings).

Recommendation 3-1: Research is needed to determine concentrations of pollen plumes as they are released from plants and concentration variations on shorter time scales in the ambient air.

Finding 3-2: Fungal aerosol plumes in outdoor air are likely to trigger false alarms in bioaerosol detectors, given the acute nature of the factors leading to massive releases. Fungal aerosols well in excess of 1,000 spores per liter have been documented, and with more accurate analysis, concentrations are likely to prove much higher.

Recommendation 3-2: Fungal aerosols need to be monitored on a much shorter time scale using traditional approaches as well as those similar to the approaches that will be used in bioagent detectors.

Finding 3-3: Virtually no good data are available in the literature on outdoor bacterial aerosols, with respect to either total bacterial counts or the types of bacteria in aerosols. These aerosols have been measured in concentrations exceeding 10^4 per liter and can trigger false alarms in nonspecific detectors.

Recommendation 3-3: Studies need to be conducted evaluating concentrations of bacterial aerosols and their variability over relevant time scales using methods similar to those likely to be used in bioagent detectors.

Finding 3-4: The types and concentrations of viral particles are unknown in outdoor air.

Recommendation 3-4: Viral particles need to be assessed in outdoor air, along with parameters controlling releases and variability in the aerosols.

Finding 3-5: Clouds of other particles have been reported sporadically in air. For example, soy aerosols have caused widespread asthma epidemics during unloading of ships in harbors, indicating clouds of soy particles that are transported to distant sites in concentrations high enough to cause illness. Other kinds of bioaerosols probably occur in a similar manner but have yet to be reported.

Recommendation 3-5: An assessment of the likelihood of these other kinds of aerosols needs to be performed.

Indoor Aerosols

Finding 3-6: Pollen is probably not of great concern indoors, as long as outdoor concentrations are well studied.

Recommendation 3-6: Studies of indoor pollen may safely be limited to understanding outdoor-to-indoor transport mechanisms.

Finding 3-7: Fungal spore aerosols indoors will be problematic in buildings where active growth is occurring. Understanding the release parameters from such sources is a necessary precursor to predicting the frequency and magnitude of releases.

Recommendation 3-7: Indoor fungal spore aerosols need to be studied using both traditional methods (which allow detection of unexpected organisms) and new methods.

Finding 3-8: Bacterial concentrations are essentially unknown indoors in spite of the fact that many studies (using culture) have been performed.

Recommendation 3-8: Indoor bacterial aerosols need to be mapped using methods that are less selective than culture methods.

Finding 3-9: Many potential biothreat agents (e.g., *Bacillus anthracis*) are probably part of the natural indoor aerosol in some form or other (possibly not infective). These could become a source of false alarms in some detection systems.

Recommendation 3-9: Surveys for specific organisms that are considered potential bioagents need to be conducted.

Finding 3-10: Viral aerosols have not been studied indoors, nor has the presence or absence of specific agents been evaluated.

Recommendation 3-10: Studies need to be done and should use the same methods as are expected to be used in bioagent detectors.

Predictive Models

Finding 3-11: If the high variability—both geographically and over time—in microbial aerosols is not understood and accounted for, it is likely to lead to an unacceptable level of false positive alarms in bioaerosol detection systems, thereby limiting the smallest attack they can confidently detect.

Recommendation 3-11: The feasibility of using predictive models for bacterial and fungal aerosols to allow the development of algorithms that can normalize and differentiate the signal from these natural clouds from the bioaerosol detector signal should be studied.

Sampling Strategies to Obtain Critical Missing Data

Finding 3-12: Sampling in outdoor air represents a major effort but needs to be done in representative areas of concern, since geographic differences in bioaerosol concentrations and populations are profound.

Air sampling is probably the method of choice for outdoors, although source sampling in particularly at-risk locations would be advisable. The primary use of source sampling is to allow for the extremely difficult problem of collecting air samples that are representative in time and space. Sources that could be evaluated outdoors include living and dead vegetation, soil, water, effluents from cooling towers, and composting materials. Some of these data may already be available in the plant pathology literature.

Recommendation 3-12: A widespread outdoor air sampling network needs to be developed that will accumulate data for a wide variety of environments. In the United States, sampling at the EPA air monitoring sites would be a useful start.

Some more intensive sampling (i.e., multiple sample sites within one community) should be done to determine the representativeness of any single sample site and to contribute to the development of predictive models. Sampling needs to be continuous and should cover several years, especially in view of current climate variability, and it should use not only the same detection methods but also the same types of sampling equipment that are likely to be used for bioagent detection. One possible approach to broad area monitoring would be to coordinate efforts of federal agencies—e.g., the Environmental Protection Agency (EPA), the Transportation Security Administration (TSA), and the National Institute of Standards and Technology, to develop protocols for periodically collecting air samples from various locations throughout the continental United States—and perhaps neighboring skies—for standardized testing. However, equipment would have to be modified so as to allow collection of samples on a time-discriminated basis (minutes).

Finding 3-13: The major problem with indoor air sampling is the variety of buildings and conditions that occur and the sporadic nature of bioaerosol releases. For example, in one building sampled over 2 weeks, 1-minute average peak concentrations of actinomycetes were in excess of 10,000 cfu per cubic meter on a Monday morning and near zero on Thursday afternoon.⁹⁰ Likewise, in the same building, more than 5,000 *Sporobolomyces* cells were recovered on only one out of 850 samples collected in the building over a week.

Source samples are especially important indoors. Most indoor bioaerosol sources release sporadically, so that massive aerosols may only be produced during a few minutes once or twice over periods of several months. The most common source sample used indoors is dust vacuumed from floors or surfaces. While culture drastically underestimates concentrations and misrepresents population composition, still many organisms have been recovered in high concentrations (concentrations of 10^7 to 10^8 per gram of vacuumed material are not uncommon). For ducted buildings, air sampling in the return air ducts is relevant.

Recommendation 3-13: Longitudinal studies should be conducted of indoor bioaerosols associated with specific sources and activities in the types of buildings expected to be susceptible to attack.

⁹⁰ H. Burge, Harvard University. 2003. Unpublished data.

4

Bioaerosol Sampling Systems for Near-Real-Time Detection

A bioaerosol sampling system is the first stage of most detection systems for defense against attacks involving aerosolized biological agents. The basic components of an aerosol sampling system are an inlet, a size fractionation device that strips unwanted larger-sized particles and debris from the distribution, a concentrator that confines the particles in a smaller volume of air, and a collector that deposits the particles on a surface or in a liquid. The output of the sampling system varies (e.g., wet or dry, concentrated or not) depending upon the requirements of the detector.

For liquid-based detectors, the collector will involve an aerosol-to-hydrosol transfer stage that serves the function of providing a small liquid flow rate (e.g., 0.5 milliliters per minute) to the detector, and for one variation of B-cell technology (see Chapter 7),¹ the aerosol is collected in the dry state prior to the addition of B cells for analysis. In the future, there may be optical devices that can speciate airborne organisms, in which case neither a liquid-based nor a dry collector would be needed, because the particles would be identified in the aerosol state.²

Commercial bioaerosol sampling systems are available from several companies, and the Department of Defense has developed prototype bioaerosol detection systems that include sampler technologies. However, none of these systems has been optimized for the detect-to-warn function considered in this report.

Consistent with the scenarios discussed in Chapter 2, this chapter examines the requirements of bioaerosol sampler technologies for both indoor and outdoor environments. Two distinct types of samplers are required for indoor occupied environments (e.g., subway stations, airports, arenas, and office buildings), depending on whether the sampling is done from HVAC ductwork or from rooms or other open areas. The sampler in the latter application will be referred to as an area sampler. A third type of sampling system is required for the outdoor ambient environment.

The design of samplers for use in the ambient environment is presently a much more serious challenge than that for occupied environments. If an ambient sampler is to be used for protection of frontline troops, it must be portable, have minimal logistical requirements (power, consumable supplies, and operator interactions), be able to acquire samples over a broad range of meteorological conditions (wind velocity, direction, temperature, and precipitation) and be unobtrusive. If it is to be used to monitor the bioaerosol content of the ambient environment in the vicinity of a military base, a critical building, or a

¹ J.D. Harper, MIT Lincoln Laboratory. Presentation to the committee on June 13, 2002.

² Systems are already being developed that can detect moieties, such as riboflavin, NADH, and tryptophan, in biological cells owing to their fluorescence characteristics. These are discussed in greater detail in Chapter 5.

site for a mass gathering, the logistical requirements can be relaxed; however, the sampler must still be able to cope with wind speed and direction, temperature, and precipitation effects.

For the detect-to-warn (DTW) capability, emphasis is generally placed on avoiding false negatives (i.e., not underestimating the aerosol concentration) as opposed to attaining a representative sample. However, if there were to be an attack with a bioagent, it is likely that the DTW device that triggers the alarm would also be a very important source of data for retrospective determination of dose. As a consequence, there should be traceability between response of the DTW device and dose, which implies that the representativeness of the sample should be understood. Of course, in any real detector system, the cost and benefit of this added level of sophistication, as opposed to the more limited goal of determining the presence or absence of a threat and an indication of its location and magnitude, would have to be evaluated.

Some of the components used in sampling systems involve critical dimensions, and sampling systems that are designed for use in the ambient environment can be subjected to conditions that may lead to degradation of some materials. As a consequence, the use of novel materials and manufacturing processes may be required during development and production of DTW bioaerosol samplers.

PARTICLE SIZE CONSIDERATIONS

In general terms, a sampling system must be able to collect aerosol particles sized such that they can most efficiently be deposited in the human respiratory system. Traditionally, this has meant a focus on particles between 1 and 10 μm aerodynamic diameter (AD).³ However, other considerations suggest that a focus on this size range may be too limited. If, for example, the aerosol generation processes likely to be used by an attacker produce the majority of aerosol particles in sizes outside the optimal inhalation band, more effective detection could be achieved if the sampled size band is more closely matched to the generator output.

A thorough analysis of the advantages and disadvantages of extending the size range to smaller or larger sizes should include consideration of (1) the likely size distribution of threat agents as well as that of the biological and nonbiological aerosol backgrounds; (2) how the inclusion of a given size range would affect the sensitivity, specificity, and false alarm vulnerability for a given collector/sensor class; and (3) the feasibility of expanding the size range for the specific scenarios addressed for a given collector/sensor class. Also, contemporary detectors generally sense the number of cells in a particle as opposed to the number of particles. Because the number of cells increases with the cube of particle diameter for similar bioparticles, sampling particles larger than 10 μm AD may increase the sensitivity of the detection process. However, other factors such as background effects associated with sampling larger particles might counteract the benefit.

Sampling from the Ambient Environment

Particles with sizes much below 1 μm aerodynamic diameter (AD) are difficult to generate in large quantities from either liquid slurries or unground bulk powders. Moreover, if vegetative cells or virus particles were to be aerosolized as submicrometer-sized particles, environmental stresses would probably significantly reduce their viability due to the high surface/mass ratio of the particles.

To illustrate the difficulty of generating micrometer-sized droplets, consider the release of an agent through 0.01 millimeter slits in a spray boom on an aircraft traveling at Mach 1. The mean droplet size generated by this process would be approximately 10 μm diameter.⁴ If the viscosity of the fluid were higher than that of water because of the presence of an agent the droplet size would be even larger. A cloud of 1 μm droplets could be produced by this process but it would require atomization of a dilute

³ Aerodynamic diameter of a particle of arbitrary shape and density is the size of a water droplet that will have the same sedimentation velocity in air.

E.W. Stuebing, U.S. Army. Presentation to the committee on April 15, 2002.

⁴ R.D. Ingebo and H.H. Foster. 1957. Drop-size distribution for cross-current breakup of liquid jets in airstreams. NACA TN 4087.

hydrosol with the liquid being volatile. Initial droplets containing 99.9 percent (v/v) of a volatile solvent (e.g., water) and 0.1 percent agent would significantly reduce the amount of agent that could be transported by the aircraft.

Notwithstanding the above, for some specific applications particles that would be released in sizes smaller than 1 $\mu\text{m AD}$ should be considered.

Particles with sizes greater than 10 $\mu\text{m AD}$ have traditionally been excluded from consideration in bioaerosol ambient sampling because deposition of those particles in the alveolar region of the human respiratory system is considerably less effective than deposition of particles smaller than 10 $\mu\text{m AD}$,⁵ and also because naturally occurring background interferents such as plant pollens and other debris contain a relatively high fraction of particles larger than 10 $\mu\text{m AD}$, which may influence some detector systems. However, for some ambient environment sampling applications, there is justification for considering the detection of bioaerosol particles with sizes larger than 10 $\mu\text{m AD}$. From the respiratory point of view, a particle size as large as 100 μm can be inspired into the oral cavity or nasal passages with an efficiency of 50 percent.⁶ In addition, the methods used in the preparation and release of a bioaerosol can lead to a considerable fraction of aerosol particles with sizes greater than 10 $\mu\text{m AD}$. For example, if a lyophilized powder were not finely ground or if either a solid or liquid agent were released in an unsophisticated manner (low energy input to the aerosolization process), most of the organisms could be associated with sizes larger than 10 $\mu\text{m AD}$.

Figure 4.1 shows the size distributions of *Bacillus subtilis* spores that were aerosolized by a very simple process. The spores, in the form of a lyophilized, unground powder, were placed in an envelope that was processed through a mail-sorting machine, where the envelope was subjected to sudden pressure forces applied by high-speed rollers and belts. On a particle number basis, only 4 percent of the particles are associated with sizes larger than 7.1 $\mu\text{m AD}$; however, because the number of spores in a particle varies approximately with the cube of particle size, about 65 percent of the spores are associated with sizes larger than 7.1 $\mu\text{m AD}$ (volume distribution in Figure 4.1). Current speciation detectors generally respond to the number of cells, and because the number of cells in similar particles increases with the cube of diameter, it may be desirable to collect the larger particles, assuming the absence of significant changes in other effects such as increasing background interferents.

Sampling from Occupied Environments

For sampling of aerosols in building environments, either from ductwork or from the occupied environment, particles with sizes outside the nominal range 1 to 10 $\mu\text{m AD}$ should be considered.

The upper size for occupied environment sampling applications should be selected after considering several factors such as the potential methods for aerosolization of threat bioagents, the loss of particles during transport from the site of aerosolization to the sampling location, the effectiveness of filters and air conditioning components in duct sampling applications, and a realistic assessment of being able to collect a sample of the aerosol particles and transport it to the detector. In general terms, aerosol particles with sizes much larger than about 30 μm are difficult to efficiently sample and transport using this sampling apparatus, so this size could be considered as a nominal upper limit for many applications.

BIOAEROSOL SAMPLING FROM INDOOR AIR

Interior sampling scenarios include sampling from ductwork and from occupied open areas such as subway stations, airports, arenas, and office buildings. An aerosol concentrator may not be required for

⁵ M. Lippman. 1977. Respirable dust sampling. *In* Air Sampling Instruments for Evaluation of Atmospheric Contaminants, 5th Ed. Cincinnati, Ohio: American Conference of Industrial Hygienists.

⁶ S.C. Soderholm. 1989. Proposed international conventions for particle size-selective sampling. *Ann. Occup. Hyg.* 22:301-320.

building applications, because the unmodified concentration associated with an aerosol release may be sufficiently high to cause the detector to alarm. For example, if there were to be a release that effectively aerosolized 1 gram of bioagent containing 10^{12} spores into a building with a volume of 3×10^4 cubic meters (3×10^7 liters) and if the sampling were to take place from the fully mixed aerosol, a sampling flow rate of 28 liters per minute (1 cubic foot per minute, cfm) would lead to the collection of 10^6 spores per minute. Other situations could, of course, lead to either larger or smaller numbers of spores—for example, if the aerosol release were into the building air intake and if the sampler were to collect material from that duct, the integrated dose sensed by the detector during 1 minute could be several orders of magnitude higher than that sensed by a detector monitoring the air in the occupied environment.

Sampling from Building Ductwork

Bioaerosol monitoring in critical government and civilian buildings can be partially accommodated by extractive sampling from the ductwork. The fresh air intake ductwork is often at ground level and in a location that can easily be accessed by unauthorized personnel. Routine monitoring of the fresh air intake would provide a rapid warning of either a biological aerosol release at this susceptible location or intake of an externally released aerosol cloud. Also, in some buildings an effective detect-to-warn capability could be economically implemented by sampling recirculated air in the ductwork.

Extractive sampling is needed for ductwork, and because the velocities in ductwork can range from 3 to 25 meters per second⁷ and the concentration and velocity profiles at a prospective sampling location in a duct may be irregular, acquisition of a meaningful air sample is a potentially difficult challenge. There are standardized methods for batch-sampling aerosol particles from stacks such as those codified by the EPA.⁸ The batch techniques compensate for irregularities in the concentration and velocity profiles by sequentially sampling at prespecified points on a geometrical grid across the stack cross section. At each traverse point on the grid, the velocity of gas at the inlet plane of the sampling nozzle is set to equal that of the undisturbed stack velocity at the particular point. This operational mode of equal sampling and flow stream velocities is called isokinetic sampling. It is intended to assure that the collected sample is

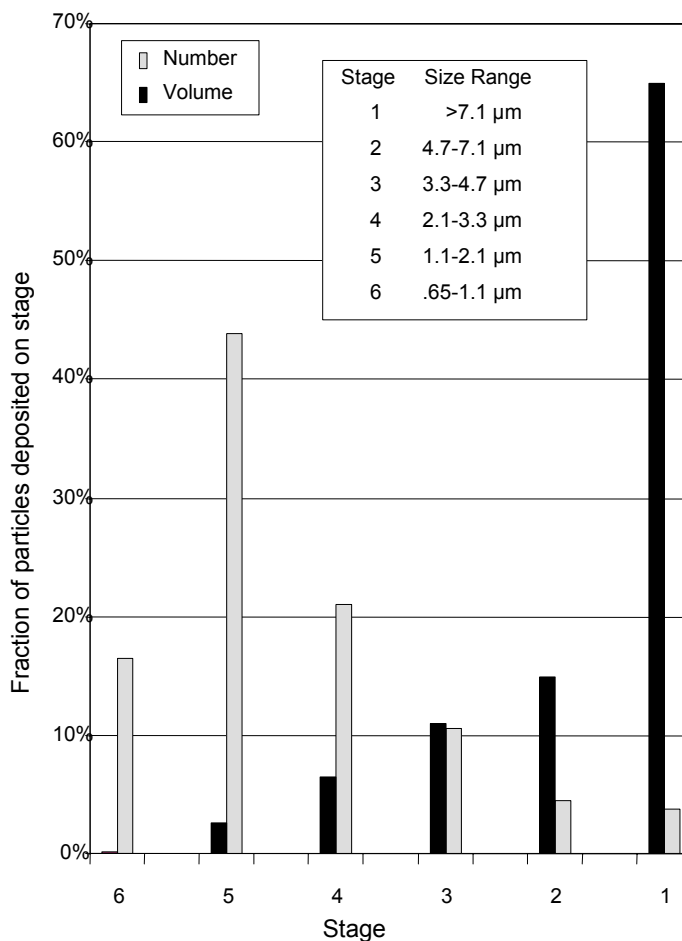

FIGURE 4.1 Size distribution of bioaerosol particles generated from a contaminated letter during a mail sorting operation.

⁷ Carrier Air Conditioning Corporation. 1960. Carrier System Design Manual, Part 2, Air Distribution. Syracuse, N.Y.

⁸ For example, 40 CFR Part 60, Method 5.

representative, provided the concentration does not change during the period in which the batch sample is collected.

Unfortunately, isokinetic sampling is not compatible with unattended operation of a near-real-time detection system for bioaerosols. Apparatus that could articulate the sampling nozzle would be complicated, and a pulse release could be significantly underestimated if the nozzle is extracting aerosol from a low-concentration region of the duct during the time of the release.

Also, there can be significant losses of aerosol particles in the nozzles and transport lines of a batch sampling system. This is not a problem for batch monitoring of stacks, because the sampling protocol requires cleaning the sampling nozzle and transport tubes at the completion of a test. For continuous monitoring for detect-to-warn purposes, however, in situ cleaning of the sampling system is not an option.

The EPA requires continuous emission monitoring of stacks and ducts in U.S. government facilities that can potentially emit significant quantities of radionuclides into the ambient environment.⁹ Until recently, EPA had prescribed use of the sampling protocol specified in a 1969 version of an American National Standard.¹⁰ For ducts larger than 152 mm diameter (6 in.), the ANSI-1969 standard recommended use of multiple sampling nozzles that would be operated isokinetically relative to the airstream.

Rakes of such nozzles (Figure 4.2) were typically used to span a duct cross section. However, there are two problems with this approach: The nozzles of such rakes will not all be isokinetic because of natural spatial variations in a velocity profile, and, more importantly, substantial aerosol particle losses can occur on the inner walls of the nozzles.¹¹ Tests with an ANSI-1969¹² nozzle operated isokinetically in an aerosol wind tunnel at 10 meters per second showed losses of 75 percent for 10- μ m AD aerosol particles,¹³ and tests with a rake of nozzles in a nuclear stack showed only 41 percent of the radionuclide activity was associated with material collected on a sampling filter, with the remainder lost in the sampling system.¹⁴

Because of problems with the extractive sampling approach used in ANSI N13.1-1969, a more robust approach was developed for continuous emission monitoring of the stacks and ducts of the nuclear industry.¹⁵ This methodology is single-point representative sampling, whereby a sample is extracted at a location in the duct where both fluid momentum and contaminant concentration are well-mixed, as manifested by the uniformity of the velocity and contaminant concentration profiles. It is the recommended approach in a revision to the ANSI standard, ANSI N13.1-1999.¹⁶ An illustration of a single-point sampling system is shown in Figure 4.3. A shrouded probe¹⁷ that has both low internal wall losses and negates the need for isokinetic sampling is used for sample extraction. It provides representative aerosol samples from the single-point in a duct under conditions for which the sampling flow rate is constant, but the air velocity in the duct is variable. These systems are optimized for

⁹ 40 CFR Part 61, Subparts H and I.

¹⁰ ANSI. 1969. Guide to Sampling Airborne Radioactive Materials in Nuclear Facilities. ANSI N13.1 New York: American National Standards Institute.

¹¹ M.D. Durham and D.A. Lundgren. 1980. Evaluation of aerosol aspiration efficiency as a function of Stokes number, velocity ratio and nozzle angle. *J. Aerosol Sci.* 11:179-188.

¹² American National Standards Institute designation.

¹³ B.J. Fan, F.S. Wong, C.A. Ortiz, N.K. Anand, and A.R. McFarland. 1992. Aerosol particle losses in sampling systems. *In* Proceedings of the 22nd DOE/NRC Nuclear Air Cleaning and Treatment Conference. CONF-9020823. M.W. First, ed., pp 310-322. Washington, D.C.: U.S. Department of Energy.

¹⁴ R.B. Schappel. 1961. An investigation of the solid particulate collection efficiency of the traverse-type stack probe. U.S. Atomic Energy Commission Research and Development Report Y-1372. Oak Ridge, Tenn.: Union Carbide Nuclear Company.

¹⁵ A.R. McFarland and J.C. Rodgers. 1993. Single-point representative sampling with shrouded probes. LA-12612-MS. Los Alamos, N.Mex.: Los Alamos National Laboratory.

¹⁶ ANSI. 1999. Sampling and monitoring releases of airborne radioactive substances from stacks and ducts of nuclear facilities. ANSI/HPS Standard N13.1-1999. McLean, Va.: Health Physics Society.

¹⁷ A.R. McFarland, C.A. Ortiz, M.E. Moore, R.E. DeOtt, Jr., and A. Somasundaram. 1989. A shrouded aerosol sampling probe. *Environ. Sci. Tech.* 23:1487-1492.

S. Chandra and A.R. McFarland. 1997. Shrouded probe performance: Variable flow operation and effect of free stream turbulence. *Aerosol Sci. Tech.* 26:111-126.

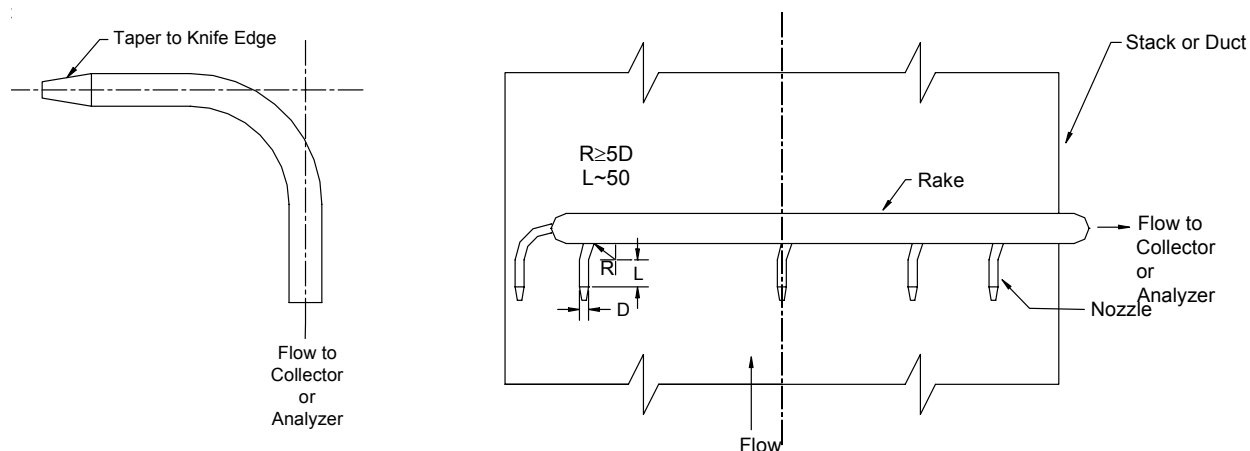

FIGURE 4.2 Rake of nozzles recommended in ANSI N13.1-1969 for continuous emission monitoring of nuclear facilities.

transmission of aerosol particles with sizes less than or equal to $10 \mu\text{m AD}$, as is illustrated in Figure 4.4; however, they have not been tested with aerosol particles as large as $30 \mu\text{m AD}$. Aerosol transmission of a sampling nozzle or probe is the ratio of aerosol concentration at the exit plane of the nozzle to the undisturbed aerosol concentration of the flow stream at the location of the probe.

Loss of aerosol particles in sample transport systems is a matter of importance in the building air monitoring scenario. Larger-sized aerosol particles (e.g., those with sizes greater than about $5 \mu\text{m AD}$) can be inadvertently deposited on internal walls of nozzles by turbulent deposition and forces set up by fluid shear; on the walls of straight tubes by gravitational settling (nonvertical tubes) and turbulent deposition; and on the walls of tube bends and fittings by inertial forces. A software code such as Deposition¹⁸ or hand calculations¹⁹ can be used to estimate aerosol particle transmission through complex transport systems; conversely, the calculations can serve as a design tool for optimizing particle transport through a system with a given geometrical configuration.

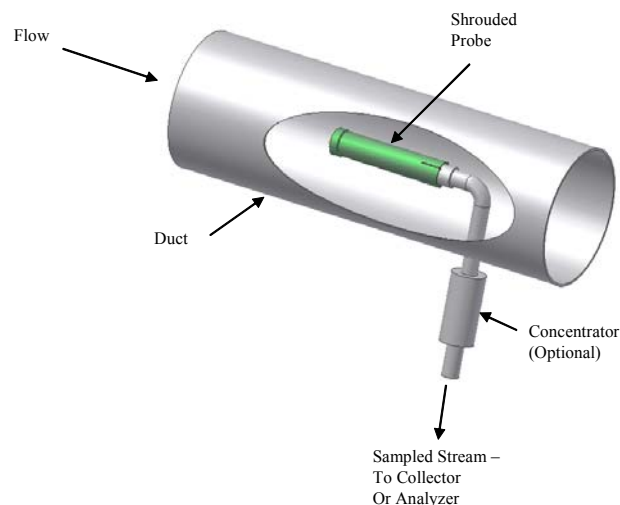

FIGURE 4.3 A generic system for extractive sampling of aerosols from a duct.

¹⁸ A.R. McFarland, A. Mohan, N.H. Ramakrishna, J.L. Rea, and J. Thompson. 2001. Deposition: An illustrated user's guide. Report 6422/03/01/ARM. College Station: Texas A&M University.

¹⁹ J.E. Brockman. 1993. Sampling and transport of aerosols. Aerosol Measurements. K. Willeke and P. Baron, eds. New York: van Nostrand Reinhold.

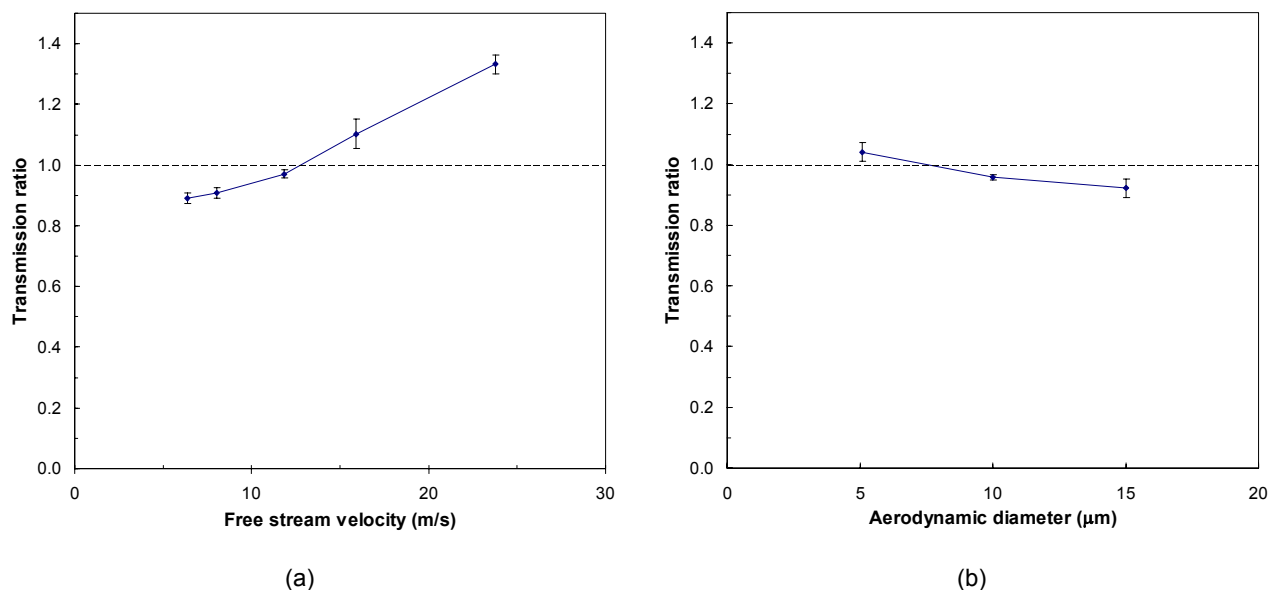

FIGURE 4.4 Sampling performance of a shrouded probe: a) Effect of duct velocity. Particle size = 10 μm AD. b) Effect of particle size. Wind speed = 12 m/s. SOURCE: S. Chandra and A.R. McFarland, A.R. (1997). Shrouded probe performance: Variable flow operation and effect of free stream turbulence. *Aerosol Sci. Technol.* 26:111-126.

The Deposition software, which is acceptable methodology for demonstrating compliance with the rules of the Nuclear Regulatory Commission²⁰ and ANSI N13.1-1999 for estimating aerosol particle losses in sampling systems, can be used to evaluate the effectiveness of systems for sampling variously sized bioaerosol particles in ductwork.

Sampler System Components

Preseparators. A preseparator may be used in a ductwork sampling system to preclude entry of debris such as lint particles into the subsequent components of the system. There are two main techniques that are used for stripping unwanted large-sized debris from the size distribution. First is a cyclonic separator, which employs vortex flow (Figure 4.5). Cyclones have the advantage that they can be operated for long intervals (i.e., several weeks) without requiring cleaning; however, they can be relatively large and therefore not only difficult to locate strategically but also to clean.

The second technique is inertial impaction, with either a classical impactor or a virtual impactor (Figure 4.6). In these devices the aerosol is accelerated in a jet, which is directed toward a solid collection surface (Figure 4.6a) in the case of a classical impactor or toward a receiver nozzle (Figure 4.6b) in the case of a virtual impactor.

For the classical impactor, the deposition of particles takes place in an area on the collection surface that is only slightly larger than the projected area of the acceleration jet, and as a consequence there can be a rapid buildup of dust on the collection surface. When subsequent particles are deposited on a dust-laden impaction surface, aerosolization of previously collected dust may take place. This can be ameliorated by fabricating the collection surface from porous media and soaking the media in oil prior to use. The oil will saturate the dust layer and minimize the aerosolization process; however, because of the restricted area over which the impaction takes place, there is still a need for frequent (every other week or so) cleaning of the collection surface.

²⁰ U.S. Nuclear Regulatory Commission. 1993. Air sampling in the workplace. Regulation 8.25.

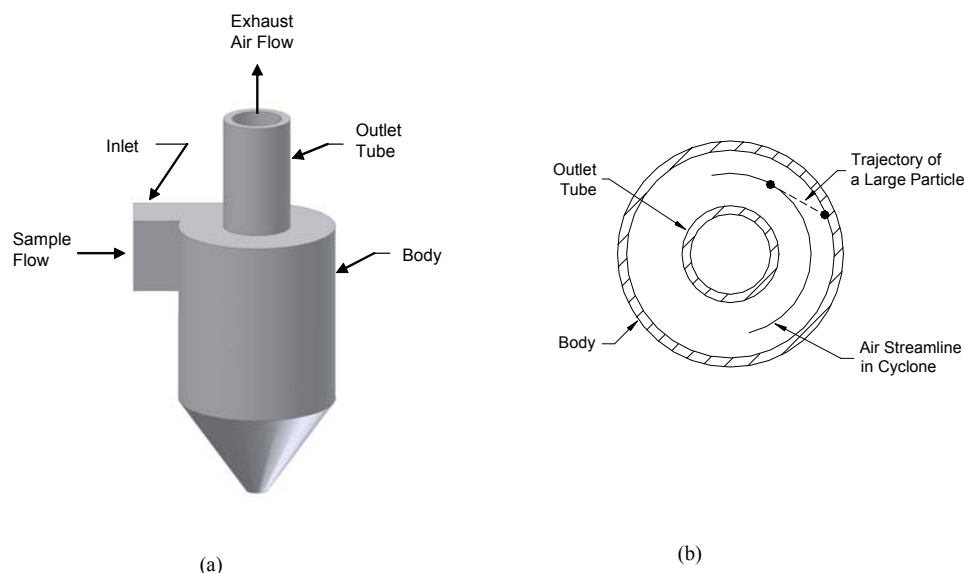

FIGURE 4.5 Cyclone separator: (a) three-dimensional view, and (b) section just below inlet.

The virtual impaction concept lends itself well to the application of stripping large particles from a size distribution. Approximately 10 to 20 percent of the air that flows through the acceleration jet is drawn into the receiver jet, where it transports the large particles from the fractionation zone, along with 10 to 20 percent of the finer particles.

Cyclone Preseparators. Empirical models have been developed that enable determination of design parameters for a cyclone that is to be operated at a given flow rate and that will provide a particular cutpoint size.²¹ For a cyclone with a single inlet and a geometrical configuration similar to that shown in Figure 4.5, the cutpoint is related to the size (body diameter) of the cyclone.²² A cyclone designed to have a cutpoint of 10 μm at a flow rate of 57 liters per minute would have a body diameter of 80 mm; however, if the cutpoint is increased to 30 μm AD, the corresponding body diameter would be 140 mm. Typically, a cyclone has a height about 4 times the diameter, so the 140 mm diameter cyclone would be about 0.6 meters high.

The variation of collection efficiency of the cyclone with particle size is shown in Figure 4.7. Ideally a fractional efficiency curve such as that shown in Figure 4.7 would be a step function, where particles smaller than the cutpoint would pass through the cyclone and those larger than the cutpoint would be collected. However, a cyclone, as with most aerosol size-fractionators, collects some of the particles that would be desirable to transmit and transmits some of the particles that would be desirable to collect. From Figure 4.7, it may be noted that if the cyclone is designed to have a cutpoint of 30 μm AD, approximately 10 percent of 20 μm AD particles will be collected and 90 percent will penetrate through it.

²¹ The cutpoint is the particle size for which 50 percent of the aerosol particles are separated from a flow stream and 50 percent are retained in the flow stream.

²² B.E. Saltzmann and H.M. Hochstrasser. 1983. Design and performance of miniature cyclones for respirable aerosol sampling. *Environ. Sci. Technol.* 17:418-424.

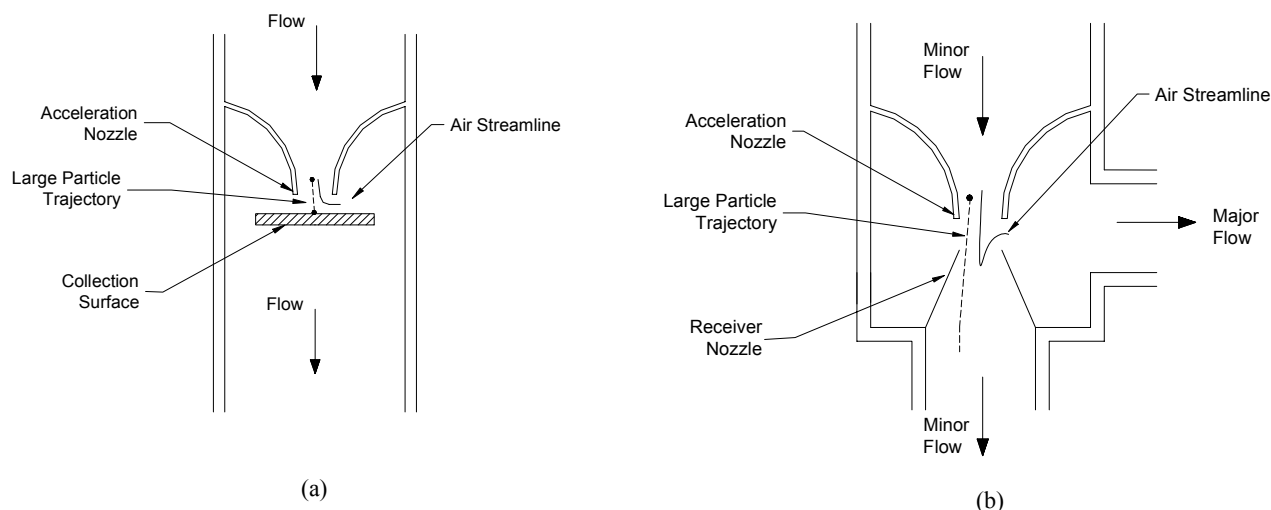

FIGURE 4.6 Inertial impactor aerosol fractionators: (a) classical impactor and (b) virtual impactor.

Preseparation with a Classical Inertial Impactor. The principle of operation of a classical impactor is that an air jet, when directed onto a flat plate, will turn abruptly at the plate surface. Particles with sufficient inertia (i.e., larger sizes) will strike the plate, whereas smaller particles can be carried with the airstream away from the impaction zone. Whether or not impaction takes place is primarily a function of a parameter called the Stokes number, Stk , which may be considered to be the ratio of the inertial (centrifugal) force exerted on a particle in a curvilinear airflow field to the drag force that tends to resist particle motion perpendicular to the curved airstreamlines. It is the motion of a particle in the direction normal to an airstreamline that causes it to strike a wall and be removed from the flow stream; thus, the larger the Stokes number, the greater the probability that a particle will impact the collection surface. With reference to Figure 4.8, the fractional efficiency of a classical circular-jet impactor is shown as a function of the Stokes number, where it may be noted the cutpoint Stokes

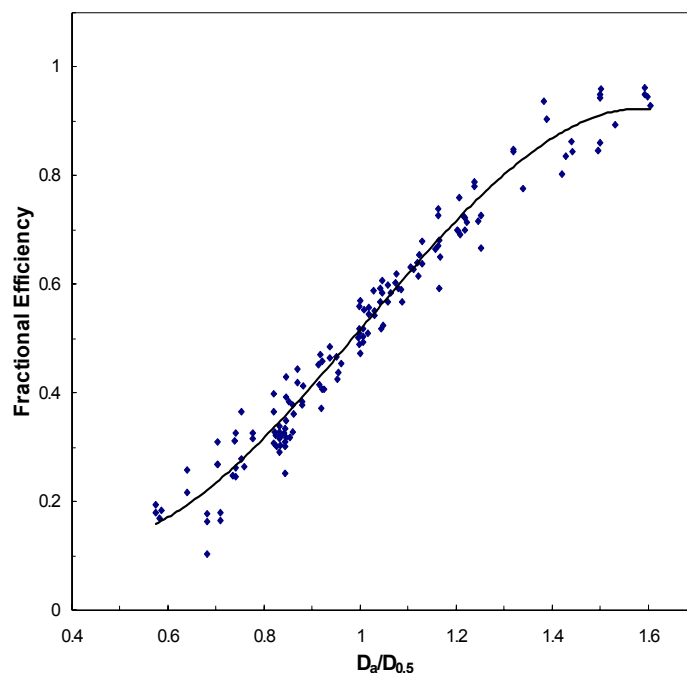

FIGURE 4.7 Variation of collection efficiency of a single inlet cyclone with particle size. D_a is the aerodynamic diameter of a particle. SOURCE: M.E. Moore and A.R. McFarland. 1993. Performance modeling of single inlet aerosol sampling cyclones. *Environ Sci. Technol.* 27:1842-1848.

number²³ is about 0.24. Here, the Stokes number is defined as:

$$Stk = \frac{C \rho_w D_a^2 U_j}{9 \mu d_j} \quad (1)$$

where C = Cunningham's slip correction,²⁴ which has a value very nearly equal to 1 for particles greater than 10 μm AD; ρ_w = density of water; D_a = aerodynamic particle diameter, U_j = velocity at the exit plane of the acceleration jet; μ = air viscosity; and, d_j = diameter of the acceleration jet at its exit plane. The cutpoint Stokes number is approximately a constant, so for a fixed flow rate different cutpoint sizes can be achieved by varying the jet diameter. For a slit impactor (rectangular acceleration jet), the jet diameter is replaced by the slit width. The cutpoint Stokes number for a slit impactor is about 0.59.

A classical impactor is compact and easy to construct; however, it can produce biased results unless cleaned frequently. Rebound of incident particles and aerosolization of collected deposits can be minimized by use of an oil-soaked impaction surface; however, fibers in the deposit will protrude into the airstream and can filter particles smaller than the cutpoint from the size distribution.

Classical impactors are widely used for pre-separation in routine ambient air sampling, where characterization of mass concentration is the goal of the sampling effort. The EPA has a standard method for sampling PM₁₀ aerosol,²⁵ which stipulates that a fractionator with a cutpoint of 10 μm AD shall be used to condition the aerosol prior to its collection. The ThermoAndersen Model 1200 sampler²⁶ accomplishes this by first passing the airflow through an impactor and then collecting the residual aerosol

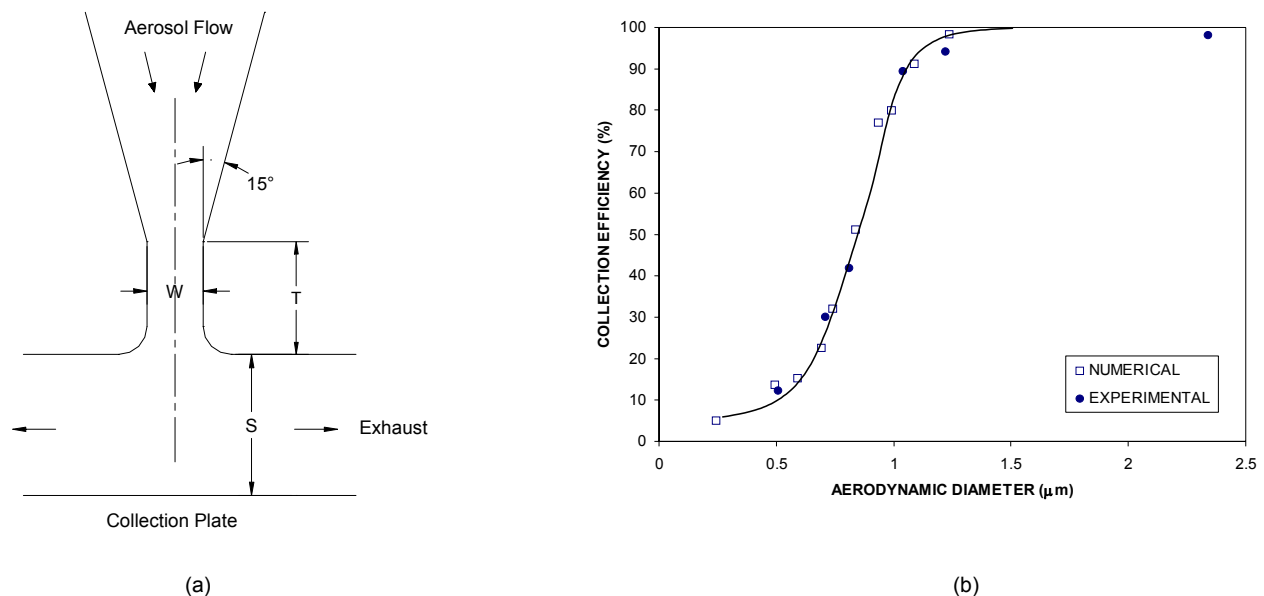

FIGURE 4.8 Classical slit jet inertial impactor with a cutpoint of 0.8 μm AD: (a) geometry showing important parameters and (b) performance. $W = 0.38$ mm; velocity of jet = 21 m/s; $S/W = 2.5$; $T/W = 2$.

²³ Stokes number for which the collection efficiency is 50 percent.

²⁴ N.A. Fuchs. 1964. *The Mechanics of Aerosols*. New York: The Macmillan Company.

²⁵ 40 CFR Part 53.

²⁶ ThermoAndersen, Inc., Smyrna, Ga.

with a preweighed filter. Nine impactor jets operate in parallel to provide a sampling flow rate of 1,130 liters per minute. The EPA reference method for collection of PM-2.5 samples²⁷ involves the use of a cup-shaped impactor to strip particle sizes greater than or equal to 2.5 μm AD from the size distribution at a flow rate of 16.7 liters per minute. Oiled collection surfaces are used in both the PM-10 and PM-2.5 impactors.

Preseparation by a Virtual Impactor A virtual impactor reduces the cleaning problem associated with a classical impactor; however, it is more expensive to fabricate and it requires two flow control systems. MSP Corporation in Minneapolis has developed a preseparator that strips particles with sizes larger than 10 μm AD from the size distribution entering an aerosol concentrator.²⁸ The flow rate into the preseparator is 330 liters per minute, of which 300 liters per minute then flow into the concentrator, while the remaining 30 liters per minute are exhausted from the system.

Particle separation in a virtual impactor is primarily a function of the Stokes number and the fraction of the flow rate, f , that is drawn into the receiver port, as shown in Figure 4.9. Geometrical parameters—for example, whether the acceleration jet is circular or rectangular and, to a lesser extent, the ratio of the spacing between the acceleration jet and receiver nozzle to the characteristic dimension of the acceleration jet—will also affect the performance. With reference to Figure 4.9, the cutpoint Stokes number is about 0.58 for a rectangular jet virtual impactor with a flow rate f of 10 percent.

When a virtual impactor is used as a preseparator, the particle stream that exits the fractionation zone through the receiver nozzle contains the debris that is to be discarded, and the fine particle stream contains the particles that are to be subjected to subsequent processing (i.e., concentration, collection, or analysis). Were it not for wall losses in a virtual impactor, the concentration of aerosol particles with sizes smaller than the cutpoint size in the fine particle stream would be approximately equal to the concentration of that size fraction in the sampled airstream. Wall losses in the fractionation zone that are based on numerical predictions (see Figure 4.9) are on the order of a few percent; however, virtual impactor preseparators with cutpoints of 30 μm AD have not been developed, and there may be other losses (e.g., gravitational) in the flow components approaching and leaving the virtual impactor that are not captured by the model used for calculating the data in Figure 4.9. Thus, the losses of the large particles (30 μm) could be significantly higher than those illustrated in Figure 4.9.

Collector Technology

As noted previously, a complete sampling system consists of inlet, preseparator, concentrator, and collector. Preseparators are discussed above. Because of the higher bioagent concentration anticipated with indoor attacks, sample concentrators will likely not be required, and discussion of concentrators is deferred to the outdoor monitoring section, below. The committee thus moves on to a discussion of collection technologies. Detection and identification systems that analyze samples in liquids, on dry surfaces, or in an ambient airstream require different collection technologies. Each of these is discussed below.

Aerosol-to-Hydrosol Transfer

For bioaerosol detect-to-warn systems that employ detectors that analyze samples in the liquid state, the sampler must efficiently transfer the aerosol into the hydrosol state. There are several devices that have been developed to accomplish aerosol-to-hydrosol transfer in a batch mode (e.g., the Spincon from Sceptor Industries in Kansas City, Missouri). However, for batch systems, the time constant associated

²⁷ 40 CFR Part 53; U.S. Environmental Protection Agency. 1997. National ambient air quality standards for particulate matter; final rule. Federal Register 62:38651-38752.

²⁸ F.J. Romay, D.L. Roberts, V.A. Marple, B.Y.H. Liu, and B. Olson. 2002. A high-performance aerosol concentrator for bioaerosol agent detection. *Aerosol Sci. Tech.* 36:217-226.

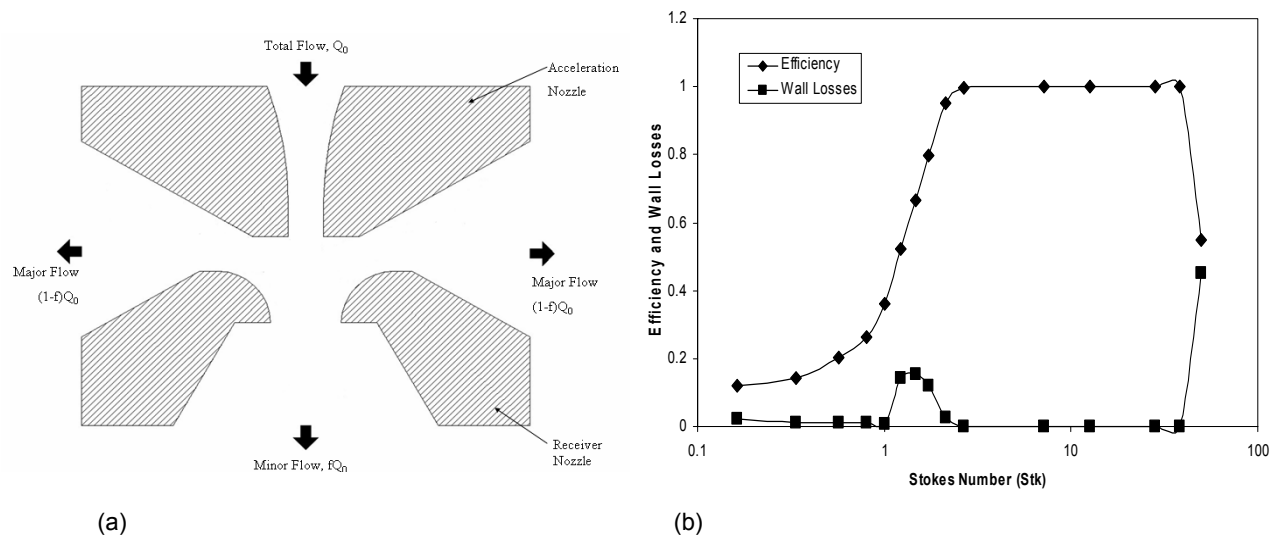

FIGURE 4.9 Virtual impactor: (a) geometry showing total flow of Q_0 entering acceleration nozzle, minor flow of fQ_0 leaving receiver nozzle, and major flow of $(1-f)Q_0$ exiting in the gap between the two nozzles, and (b) experimentally measured efficiency and internal wall losses. SOURCE: S. Hari. 2003.

with introducing new fluid, collecting a sample, and delivering the sample to a detector is on the order of several minutes, which is not compatible with a 1-minute detect-to-warn requirement.

To reduce the time constant for wet detection systems, the aerosol-to-hydrosol transfer stage (AHTS) must operate on a continuous basis. An example of such a device is the special cyclone shown in Figure 4.10. This system was developed as an aerosol-to-hydrosol transfer stage for use with an aerosol concentrator, which has a coarse aerosol flow rate of 57 liters per minute. For that device, liquid at a flow rate of 1 milliliter per minute is pumped through a porous wall of the cyclone, which serves as a collection surface for the aerosol particles with sizes $\geq 1 \mu\text{m AD}$. The high velocity tangential airstream in the cyclone carries the liquid into a small reservoir, where it is aspirated for delivery to the detector. The collection system requires very little energy to effect the particle collection—the pressure loss is only about 1 kilopascal. Because the basic collection concept is cyclonic separation of the aerosol particles, such a system can be scaled to accommodate other air sampling flow rates.

DTW systems of the future may be confronted with significantly different logistical and operational requirements than are the detectors of today. Whether a sampler is located in the field or in a building, a reduction in the consumption of liquid

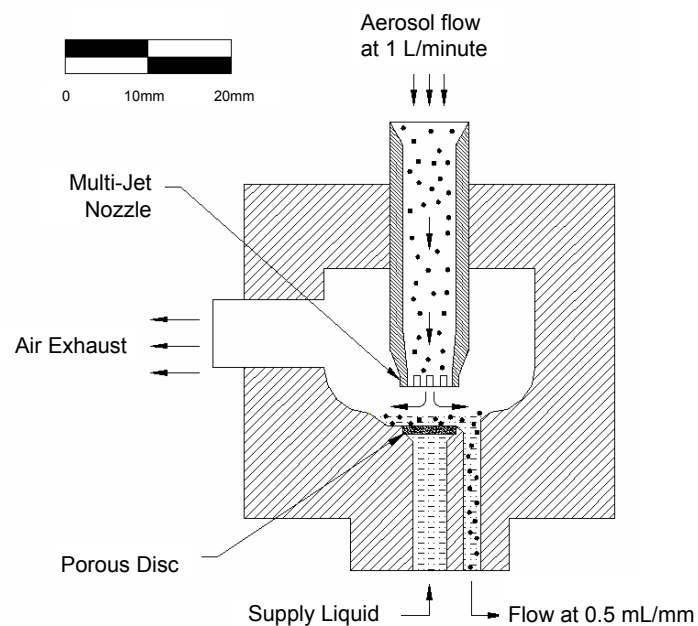

FIGURE 4.10 A wetted wall cyclone that transfers aerosol particles to a continuously flowing liquid stream.

will have an impact on the time interval between servicing and could increase sensitivity.

Dry Deposition of Aerosol Particles

One approach to bioaerosol detection with matrix-assisted laser desorption ionization (MALDI) mass spectroscopy (see Chapter 8) is to deposit the aerosol particles directly onto a tape prior to sample preparation and laser ionization. A classical inertial impactor can be used for effecting the aerosol collection. In another mass spectrometry application, a concentrated aerosol sample is passed through a tube under conditions for which turbulent deposition will cause particles with sizes greater than 1 μm AD to be deposited on the internal wall. The sample is pyrolyzed by heating the tube.²⁹

The B-cell detection technology developed by the Massachusetts Institute of Technology's (MIT's) Lincoln Laboratory³⁰ (see also Chapter 8) is effectively used in a mode where there is dry deposition of aerosol particles into a small (0.2 milliliter) centrifuge tube, which is accomplished with a classical inertial impactor. One drop of B-cell hydrosol is added to the tube, which is then centrifuged for 5 seconds prior to detection. A bench-scale prototype sensor that employs this concept utilizes a single-stage virtual impactor that is designed to concentrate 1 to 10 μm AD aerosol particles from a 33 liter per minute airflow into a 3 liter per minute flow.³¹ The efficiency of this concentrator is approximately 40 percent for particles 1 μm in size and 60 percent for particles 3 to 10 μm in size.³² A nonspeciating optical trigger (30 second detection time) is used to switch the concentrated aerosol stream (3 liters per minute) into the classical impactor.

If the air sample is collected over a 10-second time period and if the B-cell technology can detect 200 agent cells with a 99 percent probability in 45 seconds, as has been reported, 150 agent cells per liter of air could thus be detected and identified within an overall time interval of approximately 85 seconds, including the 30 second time to trigger.³³ This level of detection should be satisfactory for medium- to high-level indoor aerosol releases. For outdoor applications or for low-level trickle attacks, the system sensitivity can be improved by sampling and concentrating a higher volume of air than the 33 liters per minute. For example, operating in an untriggered continuous-sampling mode using a two-stage concentrator and an impactor, each having 70 percent efficiency per stage, and sampling at a rate of 330 liters of air per minute for 1 minute, would yield a detection level of approximately two agent cells per liter of air in a total detection time of 105 seconds.

In Situ Analysis

Techniques are also available for analyzing an aerosol stream directly without the use of a collector. In the fluorescent aerodynamic particle sizer (FLAPS) system, aerosol at a flow rate of 1 liter per minute is passed through a detector that measures single-particle aerodynamic size and fluorescence.³⁴ An XM-2 aerosol concentrator is used to provide the sample to the optical analyzer.³⁵

In another example, a MALDI mass spectrometer has been fitted with a continuous flow sample conditioning system that applies the matrix coating³⁶ without first collecting the particulate matter. The sampled aerosol is passed through an evaporation and condensation system, where the matrix is

²⁹ Hamilton Sunstrand, Pomona, Calif.

³⁰ Harper, 2002. See note 1 above.

³¹ Concentrator from MesoSystems Technology, Inc., Richland, Wash.

³² Harper, 2002. See note 1 above.

J. Kesavan and R. Doherty. 2001. Characterization of the SCP 1021 Aerosol Sampler. Report ECBC-TR-211. Aberdeen Proving Ground, Md.: U.S. Army Soldier Biological Chemical Command, Edgewood Chemical Biological Center.

³³ Harper, 2002. See note 1 above.

³⁴ P. Hairston, TSI, Inc. Presentation to the committee on April 15, 2002.

³⁵ S. Jhaveri, R. Kirby, R. Conrad, E.J. Maglott, M. Boswer, R.T. Kennedy, G. Glick, and A.D. Ellington. 2000. Designed signaling aptamers that transduce molecular recognition to changes in fluorescence intensity. *J. Amer. Chem. Society* 122:2469-2473.

³⁶ L.M. van Baar, C.E. Kientz, M.A. Stowers, A.L. van Wuijckhuijse, and J.C.M. Marijnissen, Netherlands Organisation for Applied Scientific Research TNO. Direct aerosol detection. Presentation to the committee on September 25, 2002.

condensed onto the particulate matter, and the coated aerosol subsequently drawn into the mass spectrometer.

If an expensive detection system was to be utilized in an application involving sampling of aerosols from the ductwork, and if it was desirable to sample from several ducts, there is a question about whether the aerosol could be efficiently transported from the ducts to a centralized detection location. The deposition of aerosol particles on internal walls of transport lines depends on the tube size (cross section and length) and orientation (vertical or horizontal), number and shape of bends, airflow rate, and particle size. Typically, the greatest losses will occur for particles at the upper end of the size distribution, ca 30 $\mu\text{m AD}$.

To bound the problem, the committee assumed that the penetration of 30 $\mu\text{m AD}$ aerosol particles from an air conditioning duct to the sampling location should be at least 50 percent. If a sample transport tube was 35 mm and the flow rate was 57 liters per minute, the penetration would be reduced to 50 percent in less than 1 meter of length. In contrast, if the transport tube diameter was 270 mm diameter and the flow rate was 10,000 liters per minute, the penetration would be reduced to 50 percent in a horizontal run of about 15 meters. Aerosol transport with such large ducts is feasible; however, it may be tantamount to installing additional air conditioning ducts.

SAMPLING FROM OCCUPIED ENVIRONMENTS

Direct aerosol sampling from occupied environments is likely to be much more expensive than ductwork sampling, at least with current technologies. Many more samplers would be required to reliably detect bioaerosols in the various rooms or occupied areas, compared with the ductwork case. In addition, operating costs, including maintenance and logistical requirements, also are expected to be larger if area samplers are used. If, in the future, inexpensive, reliable samplers are developed that could be deployed in large numbers similar to smoke alarms, a more important role could be anticipated for area samplers. However, at the present time, area samplers are most relevant to occupied environments where ductwork sampling is not an option, e.g., occupied environments with no central air conditioning systems.

Sampling systems for detection of bioaerosol particles in the occupied environment of a building are of relatively straightforward design, as shown by the sample system in Figure 4.11. Air is sampled in an omnidirectional manner through an inlet, which typically will fractionate unwanted larger aerosol particles. The inlet could include a screen to prevent entrance of insects and other large debris. Screens with mesh sizes larger than 16 wires per inch will allow sampling of 10 $\mu\text{m AD}$ aerosol particles³⁷ but will preclude the entrance of spiders, whose webs can interfere with the aerosol transport process, small insects that

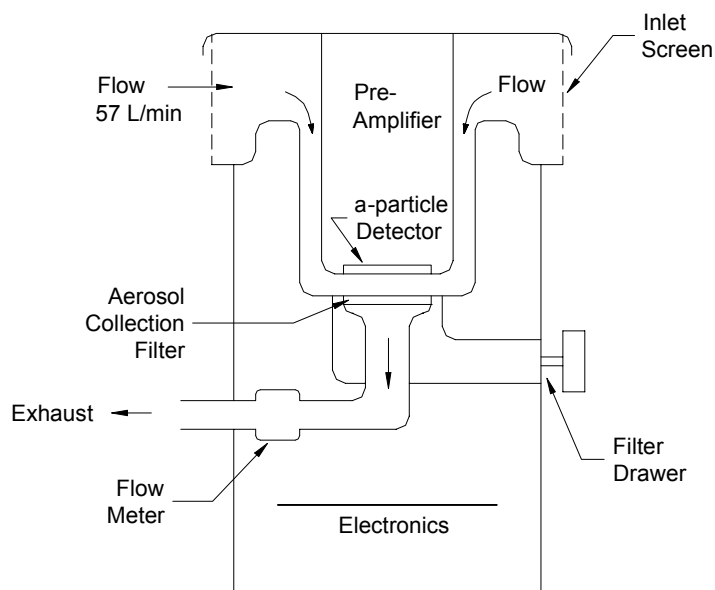

FIGURE 4.11 Example of an occupied environment sampler.

³⁷ A.R. McFarland, J.C. Rodgers, C.A. Ortiz, and M.E. Moore. 1991. A continuous sampler with background suppression for monitoring alpha-emitting aerosol particles. *Health Physics* 62:400-406.

could navigate through the sampling system to the detector, or lint that could be inadvertently deposited on critical internal surfaces and cause biased sampling.

Such sampling systems are widely used in laboratories where nuclear materials are handled or processed. The Alpha Sentry, made by Canberra Industries in Meridian, Connecticut, is used to continuously monitor for the presence of alpha-emitting radionuclide aerosol particles. A similar apparatus, but with no entrance screen, is manufactured by Thermo Eberline in Santa Fe, New Mexico. Both of these systems allow transmission from the room environment to a collection filter of at least 80 percent of 10 μm AD aerosol particles. Fractionation of larger particles occurs because of a sharp 90-degree turn that the airflow must negotiate to enter a small (5 mm) gap between the collection filter collector and a planar detector. Such a bend would not be needed in a bioaerosol sampler. If an inlet is to be fitted with a fractionator with a prescribed cutpoint, either a cyclone or an impactor (classical or virtual) could be used to scalp the larger particles.

An impactor is more compact than a cyclone and would generally be preferred. The inlet should provide a sample flow rate of at least 30 liters per minute, which will transport aerosol particles in the range 1 to 30 μm AD to a collector such as an aerosol-to-hydrosol stage or a dry collector, depending on the requirements of the detector. For most occupied environment applications, the use of an aerosol concentrator would not be warranted since the device would increase size, noise, and cost. As noted in the discussion on ductwork sampling, however, some of the contemporary detectors are designed to be coupled directly with concentrators.

The near-real-time radionuclide aerosol detection systems of the nuclear industry have focused on aerosols that will penetrate to the thoracic region of the human respiratory system and not on particles with sizes as large as 30 μm AD. It is anticipated that new inlet designs will need to be developed to accommodate sampling of these larger bioaerosol particles.

An important aspect of sampling in the occupied environment is the optimal placement of samplers. In general, the greater the number of samplers, the higher the probability of detection; however, the availability of resources for system procurement and system operation dictate that the number of samplers in any occupied environment must be small.

The U.S. Nuclear Regulatory Commission³⁸ and the U.S. Department of Energy³⁹ have developed guidelines for workplace sampling that suggest that consideration be given to airflow patterns when selecting locations for sampler placement. However, the advice is not specific but simply states that tracer tests (e.g., visible smoke) should be performed to determine the airflow patterns prior to selecting sampling locations.

A study was conducted at Los Alamos National Laboratory⁴⁰ on the placement of continuous air monitors in a nuclear laboratory, where the monitors are designed to provide the detect-to-warn function for workers who might be exposed to transuranic aerosols as a result of accidental releases. In a room with 6 to 12 air changes per hour and with 12 detectors (simulated by optical particle counters), the times for detection of an aerosol puff were on the order of 2 minutes, even though the optical particle counters had response times of 10 seconds. Clearly, in buildings where the density of samplers would be much less than that of these experiments, judicious sampler placement is paramount for detection to occur within a several-minute time frame.

³⁸ U.S. Nuclear Regulatory Commission. 1993. Air sampling in the workplace. NUREG-1400. Washington, D.C.: Office of Nuclear Regulatory Research.

³⁹ U.S. Department of Energy. 1999. Air monitoring guide for the use with Title 10 CFR 935, Occupational Radiation Protection DOE G441.1-8. Washington, D.C.: Office of the Assistant Secretary for Environmental Safety and Health.

⁴⁰ J.J. Whicker, P.T. Wasiolek, and R.A. Tavani. 2001. Influence of room geometry and ventilation rate on airflow and aerosol dispersion: Implications for worker protection. *Health Physics* 82:52-63.

J.J. Whicker, Los Alamos National Laboratory. Presentation to the committee on April 15, 2002.

SAMPLING BIOAEROSOLS FROM AMBIENT AIR

The requirements for outdoor (ambient) air samplers are considerably different from those for building ducts and occupied environments because the concentrations of biological agents to be detected in outdoor release scenarios are likely to be significantly lower than those in indoor release scenarios. Suppose one agent-containing particle per liter of air (ACPLA) is to be detected in the ambient environment with a hydrosol-based detector that can sense the presence of 10^3 organisms per milliliter of liquid. If the air sampling system were to provide a hydrosol flow rate of 0.5 milliliter per minute, then the air sampling rate would need to be at least 500 liters per minute. This flow rate is about 10 times greater than that which would typically be considered for building applications and simply reflects the different minimum detection levels anticipated for buildings and the ambient environment.

In general terms, an ambient sampler will have three major components: an inlet that accommodates a preseparator, an aerosol concentrator, and a collector. For some designs, the latter two functions are combined through use of a wetted-wall cyclone.

Two weather-related phenomena must be dealt with in the design of inlets. Precipitation must be excluded and the sampling performance must not be degraded by variations in wind speed. Entry of rain can be precluded by use of a sloped roof at the aerosol entrance section, as is illustrated in Figure 4.12, which shows a commercial inlet⁴¹ that was modified by EPA to minimize entrance of rain into the sampler body.⁴² This inlet has a bug screen, a flow decelerator in the shape of an inverted cone, and an internal impactor with a cutpoint of $10\ \mu\text{m AD}$.⁴³ Although the inlet shown in Figure 4.12 is designed for a sampling flow rate of 16.7 liters per minute, there are other commercially available inlets with much larger flow rates, up to 1,130 liters per minute.⁴⁴

Snow can be eliminated from the sampled flow stream in the inlet by the internal fractionator, but fog droplets, which can have a substantial fraction of mass in the size range of interest,⁴⁵ will be transmitted through the inlet and flow into other regions of the sampling system, where they will either be collected or perhaps evaporate. Because the total water content of fog is typically 0.1 to 0.2 grams per cubic meter,⁴⁶ considerable water could be collected in the preseparator, by the collector, or in other regions of the sampler.

The performance of some omnidirectional inlets can be significantly affected by wind speed. Inertially affected aerosol particles can be lost in an inlet as a result of curvature of the streamlines when the flow turns the corners to pass through the rain-protective elements and when the aerosol takes on a vortex flow pattern. Because the phenomena that induce losses are related to airstreamline curvature, the losses can be characterized as Stokes number dependent. The Stokes number is proportional to the square of a particle's size and to velocity (e.g., wind speed) and is inversely proportional to the characteristic dimension of the part of the inlet system under consideration (e.g., the diameter of the flow exit port in the inlet).

Almost all of the development effort related to ambient inlets has been directed toward the goal of engineering systems that will mimic the performance of the extrathoracic region of the human respiratory system by stripping particles with sizes larger than $10\ \mu\text{m AD}$. Little information is available on the performance of inlets for particles of $30\ \mu\text{m AD}$. McFarland et al.⁴⁷ tested an EPA-approved total

⁴¹ Model 246b, ThermoAndersen, Inc., Smyrna, Ga.

⁴² M.P. Tolocka, T.M. Peters, R.W. Vanderpool, F.L. Chen, and R.W. Weiner. 2001. On the modification of the low flow-rate PM10 dichotomous sampler inlet. *Aerosol Sci. Tech.* 34:407-415.

⁴³ B.Y.H. Liu and D.Y.H. Pui. 1981. Aerosol sampling inlets and inhalable particles. *Atmos. Env.* 15:589-600.

A.R. McFarland and C.A. Ortiz. 1984. Characterization of Sierra-Andersen PM-10 inlet model 264B. Report 4716/02/02/84/ARM. College Station: Texas A&M University Air Quality Laboratory.

⁴⁴ Model 1200 inlet, ThermoAndersen, Inc., Smyrna, Ga.

⁴⁵ Fuchs, 1964. See note 24 above.

J.H. Seinfeld and S.N. Pandis. 1998. *Atmospheric Chemistry and Physics: From Air Pollution to Climate Change*. New York: John Wiley & Sons.

⁴⁶ Seinfeld and Pandis, 1998. See note 45 above.

⁴⁷ A.R. McFarland, C.A. Ortiz, and C.E. Rhodes. 1980. Characterization of sampling systems. *The Technical Basis for a Size*

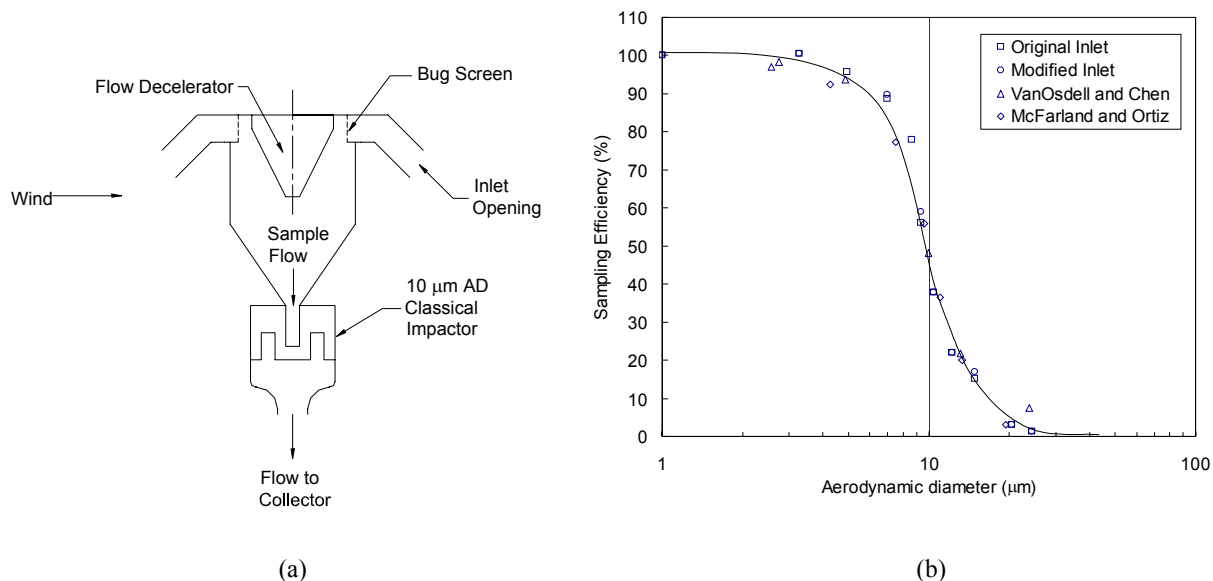

FIGURE 4.12 (a) An omnidirectional inlet with a bug screen and an internal fractionator, and (b) sampling performance of the inlet, flow rate equals 16.7 liters per minute.

suspended particle sampler,⁴⁸ which does not have an internal fractionator, and reported that the cutpoint was approximately 30 μm AD at a wind speed of 8 kilometers per hour.

To accommodate a particle cutpoint as large as 30 μm AD, new inlet designs need to be developed. Performance degradation of an inlet associated with larger particle sizes can be reduced by use of larger dimensions, or perhaps by use of a more effective means for decelerating the airflow inside the inlet before the point where the flow becomes entrained in the vortex zone.

AEROSOL CONCENTRATORS

The most critical component of existing ambient sampling systems is a concentrator that will enhance the concentration in the 1 to 10 μm AD range by as much as 1,000. SCP Dynamics of Minneapolis has developed a family of aerosol concentrators that are based on the principle of virtual impaction. A typical system is the SCP Model 1001, which samples air at a flow rate of 1,000 liter per minute and concentrates particles in the range of 2.5 to 10 μm AD into a flow stream of 1 liter per minute. MSP Corporation, also of Minneapolis, developed a virtual impactor that samples at a flow rate of 300 liters per minute and concentrates aerosol particles in the range of 2.5 to 10 μm AD into a coarse aerosol particle exhaust flow rate of 1 liter per minute.⁴⁹ The JBPDS has a cyclone concentrator that samples air at a flow rate of 780 liters per minute and concentrates the particulate matter into a hydrosol flow of 1 milliliter per minute, which is then subjected to near-real-time bioanalyses. In the 1960s, Aerojet-General Corporation in Rancho Cordova, California, developed a 1,000 liter per minute vertically oriented glass cyclone that uses an upstream water spray to wet the internal surface of the cyclone. The hydrosol is then aspirated from the bottom of the cyclone.⁵⁰

Specific Particulate Standard. Parts I and II. Pittsburgh, Pa.: Air Pollution Control Association.

⁴⁸ 40 CFR Part 50, Appendix B.

⁴⁹ F.J. Romay, D.L. Roberts, V.A. Marple, B.Y.H. Liu, and B. Olson. 2002. A high-performance aerosol concentrator for bioaerosol agent detection. *Aerosol Sci. Tech.* 36:217-226.

⁵⁰ J.M. Macher. 1999. *Bioaerosols: Assessment and control*. Cincinnati, Ohio: American Conference of Industrial Hygienists.

If the particle size range of interest for detect-to-warn ambient aerosol sampling systems is taken to be from 0.5 to 30 μm AD, effort will need to be devoted to develop new inlet and concentrator systems that will accommodate this extended range. Although both the air sampling flow rate and the flow rate of an enriched aerosol or a hydrosol stream are driven by the application and the performance of the detector, these numbers will typically be approximately a sampling flow rate of 500 liters per minute and a coarse particle flow rate of 1 liter per minute or a hydrosol flow rate of approximately 1 milliliter per minute.

Performance of Virtual Impactor Aerosol Concentrators

The effectiveness of a concentrator can be considered in terms of two parameters: the fractional penetration or efficiency and the concentration factor. For some detection concepts there can be problems with background contaminants in the submicrometer range, e.g., the fluorescence of diesel particulate matter. Because a cyclone essentially collects particles larger than the cutpoint size and exhausts particles smaller than the cutpoint with the airstream, the cyclone offers the advantage that it not only concentrates the particles of interest (sizes larger than the cutpoint) but also eliminates small background contaminants. On the other hand, in a virtual impactor, the concentration of particles with sizes smaller than the cutpoint is approximately the same in the coarse particle flow stream as it is in the ambient air. However, if the coarse particle flow stream is collected by a classical impactor or a cyclone prior to analysis, small background particles will be eliminated.

For a virtual impactor concentrator, the fractional efficiency is the ratio of the particle mass flow rate associated with a given small interval of particle size in the exhaust stream of a concentrator to the particle mass flow rate for the same size interval in the sampled airstream. Inadvertent losses of aerosol particles on the internal walls of a concentrator reduce the fractional penetration. In the case of a cyclonic concentrator, particle collection on the wetted internal walls of the device is the desired goal, so fractional efficiency is used to characterize performance. Fractional efficiency is the difference in value between unity and the fractional penetration.

The concentration factor is the ratio of aerosol mass concentration associated with a given small interval of particle sizes in the exhaust stream of the concentrator to the concentration of that same size interval in the inlet stream. Were it not for internal losses of aerosol particles, an ideal concentrator would produce a concentration factor for the particle size range of interest (particles larger than the cutpoint) that would be equal to the ratio of the volumetric flow rates of the inlet and outlet (containing particles of interest) flow streams.

Haglund et al.⁵¹ tested an SCP Model 1001 in an aerosol wind tunnel and reported the fractional penetration. Peak penetration of 78 percent is associated with a particle size of about 4 μm AD. Lower efficiencies are associated with smaller particles because of the fractionation characteristics of a virtual impactor, and lower efficiencies are associated with larger particles because of internal wall losses, which primarily occur in the nozzles and fractionation zones of the latter stages of the multistage system. This apparatus was designed to concentrate aerosol particles in the range 2.5 to 10 μm AD, and the mean penetration over that size interval is 48 percent. Because the ratio of flow rates for the device is 1,000:1 and the mean penetration is 48 percent, the mean concentration factor over the range 2.5 to 10 μm AD is 480. If an aerosol-to-hydrosol stage were added to the concentrator, it would transfer 25 percent of the particles (wall losses of 75 percent) in the 1 liter per minute flow rate at the exit port to a liquid flow rate of 0.5 milliliters per minute, and the overall concentration factor would be 240,000.

From the manufacturing point of view, it becomes increasingly difficult to fabricate virtual impactors as the cutpoint is reduced. Consider a slit virtual impactor for which the cutpoint is to be reduced by varying the slit width. Total flow rate would be held constant by maintaining a constant velocity, achieved by adjusting the slit length to compensate for changes in the slit width. The cutpoint is primarily dictated

⁵¹ J.S. Haglund, S. Chandra, and A.R. McFarland. 2002. Evaluation of a high volume aerosol concentrator. *Aerosol Sci. Tech.* 36:690-696.

by the Stokes number, and, as shown in Equation 1, the required slit width varies as the square of cutpoint size. To achieve a cutpoint of 2.5 μm AD will typically require a slit width of about 0.67 mm (0.03 in.); however, a cutpoint of 0.7 μm would imply a slit width of about 0.06 mm (0.002 in.). The latter width is extremely difficult to achieve with contemporary machining techniques.

Bergman⁵² patented a virtual impactor with multiple parallel slits that could be made from silicon, which has a cutpoint of 2.5 μm AD, and Haglund et al.⁵³ reported on a circumferential slit virtual impactor with a cutpoint of 1 μm AD. The circumferential impactor is fabricated on a lathe where close tolerances can be achieved; however, a cutpoint of 0.7 μm AD pushes the current limits of machining. Also, for virtual impactors with small slit or nozzle dimensions, there is a problem of cleaning, particularly for the latter stages of multistage devices where the concentration at the entrance plane is high.⁵⁴ Indeed, if the design cutpoint were 0.5 μm AD, the slit widths would be comparable in size to the upper end of the 0.5 to 30 μm range, which suggests the nozzle could be plugged by some of the very particles it is designed to transmit.

Performance of Cyclonic Concentrators

The Aerojet General cyclone is designed to sample air at a rate of 1,000 liters per minute and to concentrate the particulate matter into a liquid flow rate of 1 milliliter per minute, thereby providing an ideal aerosol-to-hydrosol concentration factor of 10^6 . Fractional efficiency for the cyclone is about 50 percent over the range of 1 to 10 μm AD.⁵⁵ Correspondingly, the average concentration factor over that size interval is approximately 500,000.⁵⁶ However, those test data were collected by comparing the aerosol concentration in the outlet airflow stream to that in the inlet airflow stream and do not provide information on whether the particles were actually transferred to the water. The water collection fluid in the cyclone does not uniformly wet the internal walls of the cyclone but rather tends to form rivulets on the internal cyclone wall, so the calculated concentration factor would be an overestimate of the hydrosol collection efficiency.

There are two important differences between existing virtual impactor and cyclonic concentrators. First, a virtual impactor concentrates particles with sizes greater than approximately its cutpoint. However, it also transmits smaller sizes at concentration values that are essentially equal to those in the sampled air. In contrast, the collection efficiency of a cyclone tends to zero for small particles. Second, and more important, is that with present technology, cyclones with submicrometer cutpoints are practical; however, virtual impactors with cutpoints smaller than about 2 μm AD, which have low internal wall losses and are easily cleaned, are not yet achievable on a commercial scale.

Novel Concentrators

Research is being conducted on two nonclassical approaches to aerosol concentration, ultrasonic and electrostatic. The ultrasonic approach involves subjecting an aerosol stream to a standing sound wave⁵⁷ that causes the aerosol particles to concentrate at the nodes. The physics of acoustic motion of aerosol particles has been studied in the context of ultrasonic coagulation,⁵⁸ however, the application to

⁵² W. Bergman. June 11, 2002. Low pressure drop, multi-slit virtual impactor. U.S. Patent 6,402,817.

⁵³ J.S. Haglund, S. Hari, H. Irshad, Y.A. Hassan, and A.R. McFarland. 2002. Bioaerosol sampling and collection. Presentation at Scientific Conference on Obscuration and Aerosol Research, Aberdeen Proving Ground, Md., June 25.

⁵⁴ J.S. Haglund, S. Chandra, and A.R. McFarland. 2002. Evaluation of a high volume aerosol concentrator. *Aerosol Sci. Tech.* 36:690-696.

⁵⁵ A.R. McFarland and H.W. Davis. 1998. Wetted wall biological aerosol sampling system. Report 4716/01/03/98ARM. College Station, Tex.: Texas A&M University.

⁵⁶ McFarland and Davis, 1998. See note 55 above.

⁵⁷ M.J. Anderson, R.S. Budwig, K.S. Line, and J.G. Frenkel. 2002. Ultrasonic concentration of aerosol particles. Scientific Conference on Obscuration and Aerosol Research, Aberdeen Proving Ground, Md., June 25.

M. McDonnell, Dstl. Presentation to the committee on June 12, 2002.

⁵⁸ Fuchs, 1964. See note 24 above.

aerosol concentrators is still of an investigatory nature. Electrostatic concentration is based on first imparting a unipolar charge on the aerosol particles and then focusing the particles in an electric field.⁵⁹

Both numerical and experimental techniques are being used to test the concept at the United Kingdom Porton Down facility. This concept has the potential to concentrate aerosols with a low expenditure of power, because the energy for causing particle motion is input directly to the aerosol particles rather than to the airstream, and it would not require special heating during cold weather. Also, electrostatic devices have the potential to concentrate submicrometer-sized aerosol particles.

Ideal Power to Draw Air Through a Concentrator

The consumption of power is an element of concern, particularly for those detection systems placed in the field and operated with portable electrical generation equipment. Experience with the JBPDS system has been that the aerosol concentrator uses more power than any other subsystem.⁶⁰ However, even if a concentrator were to be employed in an occupied environment, in general the higher the power consumption, the noisier the system, so for either field or indoor applications minimization of power consumption should be a goal.

The logistical requirements for placement and operation of a remote sampler can be dramatically affected by the power requirements. The sampler of the JBPDS requires 400 watts during nonfreezing conditions at a flow rate of 780 liters per minute,⁶¹ and it would require an additional 520 watts if the entire sampled airstream needs to be heated to prevent freezing when the outdoor air is at a design operational condition of -28°C . In the field, the JBPDS is connected to a 3-kilowatt generator that weighs approximately 90 kilograms (200 pounds). If the power requirements were less, not only would the weight of the generator be less, but also the generator would have a lower fuel consumption and thus lower logistical requirements.

The actual power requirement to draw air through the JBPDS concentrator is considerably in excess of the ideal power requirement, where the latter is the power to overcome frictional losses in the device. A specific measure of the ideal power is the pressure drop of the flow as it passes through a concentrator, where the pressure drop can be considered as equivalent to ideal power divided by sampling flow rate. The pressure drop value affords an opportunity to compare the ideal power consumption of two concentrators in a manner that is independent of airflow rate through the concentrator. For the JBPDS system, the pressure drop is 7.0 kPa (28 inches of water), which for a flow rate of 780 liters per minute, would require an ideal power of about 90 watts. The large difference between the actual (400) and ideal power consumption is primarily due to inefficiencies in the blower-motor combination. A more efficient blower-motor is needed for ambient sampling systems.

The ideal power requirement of a cyclonic sampling system depends strongly on the design cutpoint. Suppose a cyclone with a cutpoint of $2\ \mu\text{m AD}$ is used to sample the ambient air at a flow rate of 500 liters per minute. If it is desired to sample that same flow rate with a geometrically similar but smaller cyclone that has a cutpoint of $0.5\ \mu\text{m AD}$, the ideal power would increase from 190 pascals (0.75 inches of water) to 5.1 kilopascals (20 inches of water). Multiple small cyclones operated in parallel could be used to reduce the pressure loss; however, that would complicate the aerosol-to-hydrosol transfer process.

The pressure loss in virtual impactors can be kept low by use of extended slit lengths to accommodate both desired flow rate and cutpoint. In general, the pressure loss varies as the square of the velocity at the exit plane of the acceleration jet, but if the velocity is held approximately constant as the design cutpoint is reduced, the pressure drop will not be significantly affected.

⁵⁹ S.R. Preston, T.G. Foat, M.D. Walker, and J.M. Clark. 2002. The design for an electrostatic aerosol collector. Joint Service Scientific Conference on Chemical and Biological Defense Research. Hunt Valley, Md. November 21.

⁶⁰ T. Moshier, U.S. Army. Presentation to the committee on December 18, 2001.

⁶¹ R.S. Black and M.J. Shaw. 2002. Development of the wetted wall cyclone for the Joint Biological Point Detection System. Scientific Conference on Obscuration and Aerosol Research. Aberdeen Proving Ground, Md., June 25.

The pressure loss across virtual impactors depends on another consideration. The airstream from the acceleration jet reaches near-stagnation conditions at the entrance of the receiver nozzle, because only a small part (10 to 20 percent) of the total flow is drawn into that port. As a consequence, there will be recovery of pressure at the inlet of the coarse particle receiver, which reduces the pressure loss to near zero for that portion of the stream. Thus, as an approximation, the power loss in a virtual impactor (whether the impactor jets are circular or rectangular) is only the loss associated with the major, or fine-particle flow, of each stage.

Power Consumption to Prevent Freezing of Liquid

Concentrators such as the JBPDS system and the Aerojet General cyclone, which combine aerosol concentration with aerosol-to-hydrosol transfer, must have provisions for prevention of liquid freezing if the concentrators are used in ambient sampling applications. The simplest approach to precluding freezing is to heat the airstream before it enters the concentrator; however, that can require considerable power. If the design outdoor temperature is -28°C and the airstream is heated to 5°C , the power requirement is 2 to 3 watts per liter per minute of airflow. The JBPDS and the Aerojet General cyclones would require 520 and 670 watts, respectively, to accomplish this heating.

In contrast, virtual impactor concentrators, when used in series with aerosol-to-hydrosol transfer stages, require little extra power to prevent freezing of the liquid in the AHTS. In the case of a system such as the SCP Model 1001 concentrator, which has an airflow rate of 1 liter per minute at the exit port, only 2 to 3 watts would be needed to heat the airstream from -30°C to $+5^{\circ}\text{C}$.

AEROSOL-TO-HYDROSOL TRANSFER STAGES

SCP Dynamics, Inc., has developed a batch-type AHTS that is used with a virtual impactor that has an aerosol inlet flow rate of 1,000 liters per minute and a coarse-particle flow rate of 20 liters per minute. The AHTS collects the particulate matter in the coarse-particle airflow into 40 milliliters of liquid. This virtual impactor and AHTS both have cutpoints of about $2.5\ \mu\text{m AD}$. There are wall losses in both the virtual impactor and the aerosol-to-liquid collector, precluding efficiency values much greater than about 25 percent over the range 2.5 to $10\ \mu\text{m AD}$.⁶² If the penetration values can be increased, it may be possible to modify the SCP system to operate on a continuous flow basis.

Two AHTS devices utilize circular jet impactors to deposit the particles from a 1 liter per minute aerosol flow rate into a liquid film that flows at a rate of 0.5 milliliters per minute. The cutpoints of the two devices are 0.8 and $2.5\ \mu\text{m AD}$. The liquid film forms on a porous surface through which the liquid is transpired.

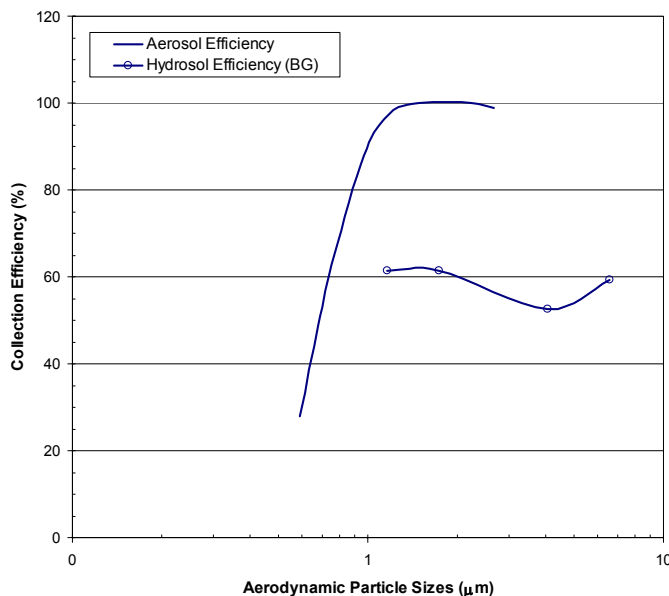

FIGURE 4.13 Collection efficiency of a combined concentrator using aerosol-to-hydrosol transfer stages (AHTS). The system is the JBPDS main sampler, which has an airflow rate of 780 liters per minute and a liquid flow rate of 1 milliliter per minute.

⁶² Kesavan and Doherty, 2001. See note 32 above.

Collection efficiency as a function of particle size is shown in Figure 4.13 for the AHTS with the 0.8 μm AD cutpoint.

The data in Figure 4.14 are for two types of experiments: One type was based on a comparison of the aerosol concentration of monodisperse liquid droplets upstream and downstream of the AHTS; the second was based on a comparison of the number of solid polystyrene aerosol particles collected per unit of time in the output liquid with the number of particles per unit time that enter the device in the aerosol state.

Results of the two experiments compare favorably and show that average efficiency over the range of interest (1 to 10 μm AD) is greater than 90 percent. The temporal response of the 0.8 μm AD cutpoint AHTS is shown in Figure 4.14, where the concentration of 2.3 μm polystyrene beads in the liquid was monitored as a function of time. The AHTS was subjected to a step increase of aerosol at a time of 0 minutes and to a step decrease at an elapsed time of 16 minutes. The time constant, which is the time

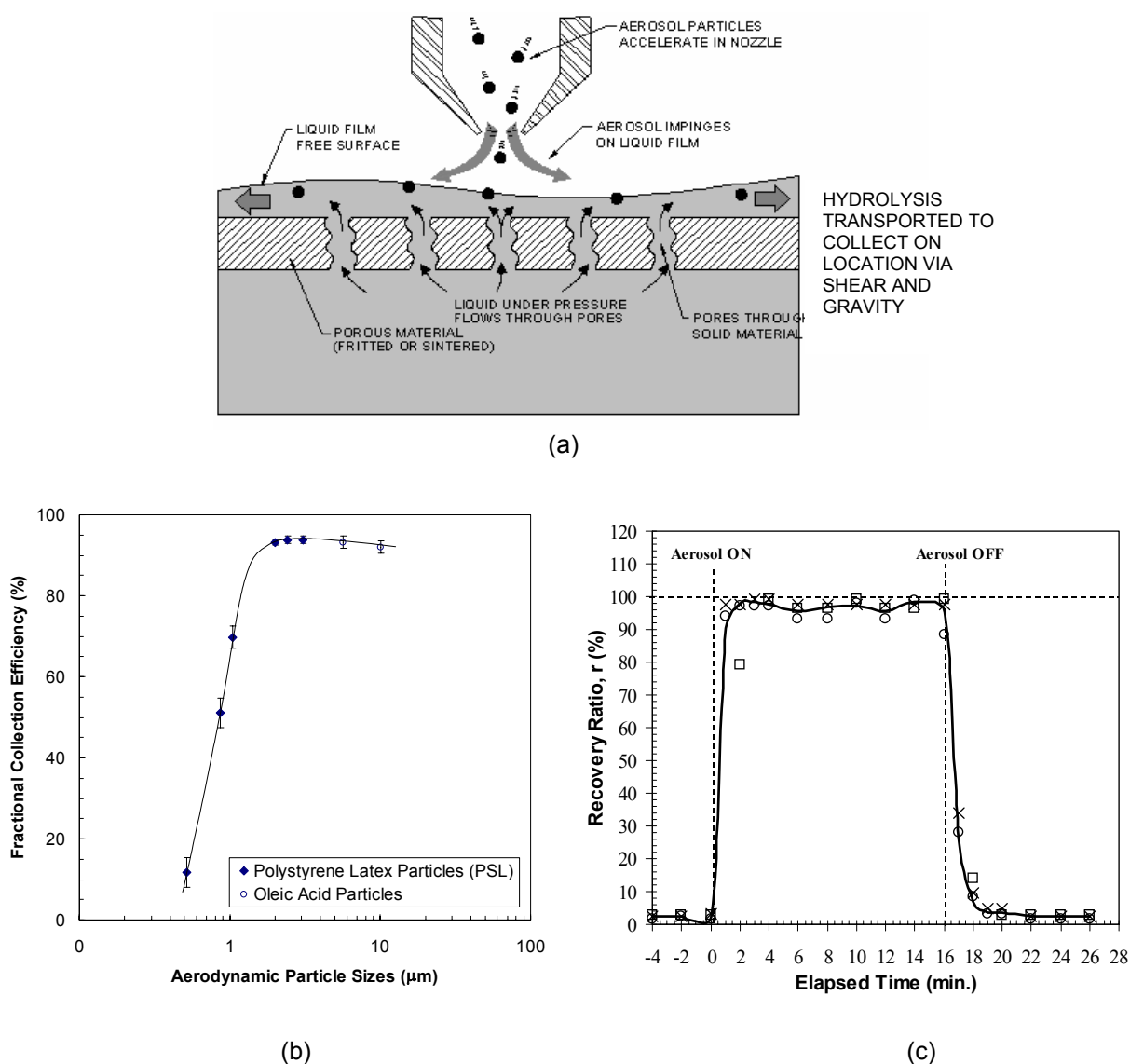

FIGURE 4.14 An aerosol-to-hydrosol transfer stage: (a) design, (b) collection efficiency, and (c) time response.

required for the hydrosol concentration to reach 63.2 percent of its equilibrium value following a step change, is about 0.8 minutes for either a step increase or a step decrease.

FINDINGS AND RECOMMENDATIONS

Below, the committee's findings and recommendations for sampling of bioaerosols in the context of detect-to-warn systems are presented for the three principal applications discussed in this chapter: ductwork, occupied environments, and ambient sampling.

Ductwork Sampling

The Department of Energy (DOE) confronted the need to continuously monitor emissions of radionuclides from stacks and ducts that could potentially emit significant amounts of radionuclides. To fulfill this requirement, the concept of single-point representative sampling was developed, and that concept is embodied in an ANSI standard method for extractive sampling of emission points in the nuclear industry.

Finding 4-1: The current ANSI standard provides methodology for extractive sampling of ducts; however, that work focused on an upper size cutpoint of 10 μm AD, whereas for bioaerosol sampling the upper size cutpoint of interest may be 30 μm AD.

Recommendation 4-1: The methodology given in ANSI N13.1 should be reviewed with reference to extraction of bioaerosol samples from building ductwork, and a comparable document should be prepared that would provide guidance to designers and users of detect-to-warn systems. Studies should be carried out to determine the advantages and disadvantages of extending the sampling capability to a cutpoint of 30 μm AD.

Finding 4-2: While the ANSI standard stipulates that samples must be extracted from locations where the velocity and contaminant concentration profiles are uniform, it does not provide guidance for selecting such locations on an a priori basis.

Recommendation 4-2: Numerical and experimental studies should be conducted to develop criteria for nozzle siting.

Finding 4-3: While work has been done on developing the individual components of bioaerosol sampling systems (e.g., nozzles, transport systems, and collectors), integration of the systems still needs to be accomplished.

Recommendation 4-3: The development of integrated, turnkey sampling systems should be supported for aerosol particles that are automatic, robust, and require little maintenance. Studies should be conducted on the advantages and disadvantages of developing systems that would extend the range for extraction, transport, and collection of aerosol particles, from 1 to 10 μm AD to 0.5 to 30 μm AD.

Finding 4-4: The time constants of current continuous flow aerosol-to-hydrosol devices are on the order of 1 minute or more, which is too long for DTW needs. Current ATHT stages have flow rates as low as 0.5 milliliters per minute; however, that is probably higher than would be desired from some DTW applications, especially those intended for use in the field.

Recommendation 4-4: Developmental efforts should be supported for ATHT stages that have shorter time constants and smaller liquid flow rates.

Occupied Area Sampling

Area sampling for protection of the occupied environment is a greater challenge at the present time than ductwork sampling. Because the probability of detection of a bioaerosol using samplers in an occupied area increases with the number of samplers, such devices must be inexpensive, unobtrusive, robust, require little maintenance, and not be prone to generating false alarms. The DOE uses near-real-time samplers in laboratories where radionuclides are handled, and the experience gained in that program should be of benefit in efforts to monitor occupied environments for bioaerosols.

Finding 4-5: There is currently no bioaerosol sampling system that is compatible with the occupied environment application.

Recommendation 4-5: In the long term, after low-cost, reliable detection systems are developed, effort should be directed to developing compact, fully automatic, low-cost, reliable, and unobtrusive area sampling systems. Studies should be conducted on the advantages and disadvantages of developing equipment with representative sampling of particles in the range 0.5 to 30 $\mu\text{m AD}$, where the values of 0.5 and 30 are to be regarded as cutpoint sizes.

Finding 4-6: Guidance is lacking on strategies for the placement of samplers to obtain the optimum trade-off between detection time and number (cost) of samplers in occupied environments.

Recommendation 4-6: Guidelines for optimum sampler placement should be developed for occupied environment applications.

Ambient Sampling

The military has undertaken an extensive effort to provide troops in the field with bioaerosol detection systems, which led initially to BIDS and now to JBPDS. The sampling and detection systems contain an inlet (with preseparation capabilities), a concentrator, and a detector.

Finding 4-7: The aerosol size range of most present interest is 1 to 10 $\mu\text{m AD}$.

Recommendation 4-7: A study should be conducted to evaluate the merits of considering sampling systems capable of detecting a 0.5 to 30 μm size range of particles.

Finding 4-8: The performance of current design ambient sampling inlets can vary with wind speed.

Recommendation 4-8: Design models should be developed that will allow users to construct optimized inlets that will provide robust performance in spite of variations in meteorological conditions and that will allow selection of a desired cutpoint size.

Finding 4-9: The currently available virtual impactor concentrators have cutpoint sizes $\geq 2 \mu\text{m AD}$, and it may be desirable to reduce the cutpoints to 0.5 $\mu\text{m AD}$. However, it may not be possible to accomplish this, because very small slit widths (or jet diameters for circular jet virtual impactors) are needed.

Cyclone concentrators with cutpoints of 0.5 $\mu\text{m AD}$ can be constructed with currently available technology; however, a single cyclone will consume considerable power and it will require more heating to prevent liquid freezing in cold weather. Also, the cyclone does not permit delivery of an aerosol sample to the detector, i.e., it is only compatible with hydrosol delivery. New concepts such as acoustic and electrostatic devices are being investigated; however, considerable work needs to be done before practical investments are realized.

Recommendation 4-9: High-capacity, easily cleanable, inexpensive, robust devices with submicrometer cutpoints and with the ability to transmit or collect (cyclone) particles as large as 30 μm AD should be developed. Use of new materials and fabrication techniques should be considered.

Finding 4-10: An aerosol concentrator can require the expenditure of considerable power.

Recommendation 4-10: The development of more efficient blowers and concentrators should be supported.

5

Point and Standoff Detection Technologies

Environmental detection of biological agents in real time is a difficult process. Not only are there a large number of different possible biological agents to detect, but many of them are similar to nonhazardous organisms normally found in the environment.¹ Once the biological agents have been transported away from their release point, their concentration may be very low compared with the background against which they must be detected. For this reason, detection at or near the point and time of release offers the best opportunity for distinguishing a potential biological agent attack from fluctuations in the natural background. Simulant tests and modeling results using a nominal density of biological agents of 10^{12} organisms per gram demonstrate that a concentration of 1,000 particles per liter or greater will remain in the vicinity of a biological agent release with a source term of approximately 1 kilogram for 5 to 20 minutes.² The actual times are extremely dependent on wind speed and proper formulation of agent. Faster wind speeds result in a more rapid dispersion of the cloud.

As discussed in Chapter 1, the detection of an aerosol cloud is distinct from the identification of the contents of that cloud. Depending on their cost and level of sophistication, detectors can provide rapid but nonspecific information about the aerosol particles, such as:

- Number of particles within a given size distribution.
- Distinction between biological and nonbiological particles.
- Possibly, in the future, distinction between viable and nonviable organisms.

The ability to distinguish biological from nonbiological particles is important for reducing false alarm rates. By contrast, identification techniques are capable of determining the specific organism or toxin used in a biological agent attack, though usually with a longer response time than detectors. As discussed in Chapter 2, detector alarms could trigger low-regret responses as well as the initiation of more specific identification procedures in a cascaded sensor architecture.

Detection technologies can be employed either as point or standoff devices. In point detection applications, the biological organisms must pass through the actual detection element. Standoff detection is detection of a biological agent cloud at some distance (on the order of kilometers) from the target and

¹ National Research Council. 1999. Chemical and Biological Terrorism: Research and Development to Improve Civilian Medical Response. Washington, D.C.: National Academy Press.

² E.W. Stuebing, U.S. Army. Presentation to the committee on April 16, 2002.

from the detector itself.³ Spectroscopic point detectors may be deployed outside at strategic locations around an extended potential target or inside buildings, either in HVAC ductwork or open occupied areas. Standoff detectors are generally considered for outdoor applications; however, this same technology can be employed for line-of-sight detection within open air structures as well. This chapter examines the current state of the art of both point and standoff detection technologies.

POINT DETECTION TECHNOLOGIES

Nonspecific spectroscopic point detectors typically consist of a particle collection and concentration system, a laser light source, and appropriate electronics for determination of the size, shape, and spectral signature of aerosol particles. Aerosol collectors and concentrators play a key role in a rapid detection system. In order for airborne particles to be characterized by a laser light source, the particles must be brought to the laser. This step sometimes involves concentration of the particles through the use of a multistage virtual impactor, discussed in Chapter 4. The virtual impactor generates an airstream of concentrated particles in the desired size range.⁴ The airflow maintains a constant velocity during the measurement period.

The measurement of a particle's size is based on its inertial behavior in the airstream; smaller particles accelerate faster than larger particles.⁵ Using a dual laser system, the time of flight of a single particle can be determined. These times are compared with reference tables generated using particles of unit density (1 gram per cubic centimeter) and defined diameters to determine particle size. Utilizing both forward and backscattered light collected by multielement intensified solid-state arrays, one can ascertain key shape information. As long as the wavelength of light is shorter than the diameter of the particle, this scattering provides useful information. Resolution of shape information can be performed to about 1 μm . Current systems can analyze between 5,000 and 10,000 particles per second.

The U.K. Dstl has developed an operation system for the simultaneous measurement of particle shape, size, and number by the spatial analysis of the scattered light pattern. Utilizing high-angle spatial scattering data from a triple photomultiplier tube (PMT) detector, researchers have demonstrated differential light-scattering patterns that allow discrimination of cubes, spheres, curved fibers, flakes, straight fibers, and an irregular background. As with most optical interrogations, the analysis is simplified for a homogeneous population.

Biological and nonbiological particles can be distinguished from one another by their light absorption and fluorescence characteristics. Standard excitation between 260 and 280 nm excites the amino acids with conjugated double bonds: tryptophan, tyrosine, and phenylalanine. Of these three, tryptophan has a fivefold greater absorption cross section than the other two (see Figure 5.1) and is the principal component of protein absorption and emission at these wavelengths.

Other sources of fluorescence that absorb at longer wavelengths are the nicotinamides and riboflavins. The fact that the reduced form of nicotinamide adenine dinucleotide phosphate, [NAD(P)H], absorbs at a different wavelength from the oxidized form, NAD(P), provides a potential method for distinguishing between viable and nonviable bacteria. When bacteria die, they convert to the oxidized state. Therefore, the differential between NAD(P)H and NAD(P) can provide viability information in near real time. Current laboratory efforts are under way to exploit this parameter. If successful, this would significantly enhance the current ability to determine viability at the same time as discriminating biological from nonbiological particles in the environment.

An example of mature particle detection apparatus is the Met One Instruments line of particle counters. These systems are representative of multichannel particle size characterization devices that can accurately count particles in a variety of size distribution windows. These systems are reliable and

³ National Institute of Justice. 2001. An Introduction to Biological Agent Detection Equipment for Emergency First Responders, NIJ Guide 101-00. Available online at <http://www.ncjrs.org/pdffiles1/nij/190747.pdf>. Accessed August 2003.

⁴ Stuebing, 2002. See note 2 above.

⁵ Stuebing, 2002. See note 2 above.

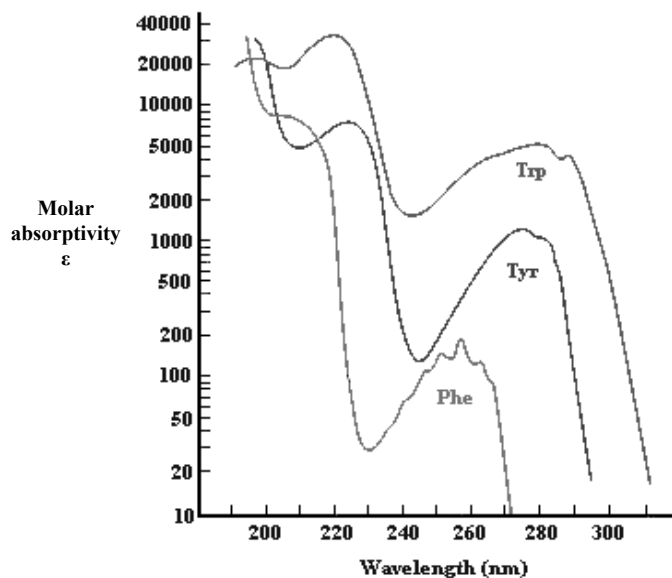

FIGURE 5.1 Ultraviolet absorption spectra of conjugated amino acids tryptophan, tyrosine, and phenylalanine.

are sold as elements of a larger system or as individual handheld devices. Although the acquisition of particle size and shape information is rapid, these systems do not provide information about the biological nature of the detected particles.

Current Instrumentation

Researchers at MIT's Lincoln Laboratory are currently funded for the development and field-testing of the Biological Agent Warning Sensor (BAWS). The BAWS system began development in 1996 and was transitioned to the Joint Program Office for Biological Defense in 1999. The current version is BAWS III, incorporating design improvements and decreases in size and power requirements relative to earlier versions. The system uses a pulsed ultraviolet laser and makes three measurements: ultraviolet energy absorbance and fluorescence, visible light absorption, and elastic scattering of ultraviolet light. The system can discriminate among dirt, bacteria, and pollen. It has also been demonstrated to detect protein-containing airborne particles that are representative of protein toxins. This system has been field-tested many times in various environments. The BAWS costs about \$100,000 per device. A recent commercial product, the Bioni, costs around \$25,000 per device. In addition, there is a DARPA program to develop ultraviolet light-emitting diodes and laser diodes.

Particle detection and discrimination systems are plagued by the reality that the environmental load of bacteria fluctuates significantly. The fluctuations frequently are related to environmental conditions and usually have a predictable variation, but this is not always the case. Indoor environments, although cleaner, also have significant variances related to the cycling of the air circulation system and movement of personnel. The approach the BAWS researchers have taken to address these natural fluctuations is to compare the current signal with that obtained over the preceding 10 to 15 minutes. This provides an internal reference to correct for ambient fluctuations. The design goal for the BAWS detection threshold was 25 agent-containing particles per liter of air (ACPLA) or better with a 1-minute response time. The system is reported to have between 1 and 20 false alarms per day, depending on the environmental conditions. A similar system has been developed jointly by the Canadian and U.S. governments and industries.

Fluorescence aerodynamic particle sizing (FLAPS) is a technology developed by TSI Incorporated and Canadian Defense Research and Development at Suffield. The technology is similar to that

employed by the BAWS system. The FLAPS system is based on the characterization of individual particles concentrated by a three-stage virtual impactor (discussed earlier). Threat determinations are based on particle size and fluorescence intensity. Size is determined using a dual laser and making calculations based on particle acceleration rates. Excitation is accomplished using a near-ultraviolet laser. The researchers have chosen the near-ultraviolet rather than the far-ultraviolet energies in an attempt to improve signal to noise ratios. The FLAPS system is reported to have a sensitivity of less than 15 ACPLA within 18 seconds with a near 100 percent probability of detection. The most recent version, FLAPS3, uses a diode laser exciting the particles at 405 nm.

The U.K. Ministry of Defence is conducting research and development on a fluorescence and shape analysis system.⁶ This system uses a dual laser that generates fluorescence as described above but adds an element that analyzes asymmetry to provide further confidence in the detection of biological particles. The log-scale plotting of fluorescence against shape analysis provides a scatter plot that can distinguish biological agents from a variety of molecules that commonly interfere in the analysis.

One approach for determining whether biological organisms are living or dead is based on detection of the presence of adenosine triphosphate (ATP) in living cells. This system requires the bacteria to be in an aqueous medium for analysis. Vegetative bacteria are lysed and the ATP interacts with an enzyme to generate light. A photomultiplier tube captures the light and generates an output proportional to the number of bacteria present. The device is called a luminometer because it determines the amount of light produced using ATP as the energy source. This approach can detect spores if the spores have had time to germinate into vegetative organisms, but ungerminated spores do not contain sufficient levels of ATP to be detected by this method. Furthermore, this technology cannot detect the presence of toxins or nonliving bacteria. Advances in technology have resulted in the production and sales of handheld luminometers from both New Horizons and Biotrace. Current sensitivity ranges for these systems are in the range of 10^5 to 10^7 organisms per milliliter (depending on the specific system), with response times of 1 to 2 minutes. These systems cannot discriminate between pathological and nonpathological bacterial species and do not provide identification.

The U.K. Ministry of Defence has an operational biological particle system that uses yet another approach. This system uses orthogonal detection techniques to discriminate biological from nonbiological as well as bacteria from pollen. The first discrimination is based on high-angle, special light-scattering properties. Different shaped particles produce characteristic scattering patterns. Particles are collected into an aqueous medium by a cyclone sampler. This particle discrimination and collection system is in line with a continuous flow luminometer for further characterization of the particulate material. The luminometer performs a differential extraction to distinguish between pollen and bacteria. During the harsh extraction, ATP is released from both bacteria and nonbacterial cells. During the weak extraction, ATP is released only from the nonbacterial cells. The difference between the two measurements represents the bacterial content of the sample. While this system provides near-real-time detection (less than a minute) of biological material, it is reagent intensive and therefore presents a logistical challenge. Efforts are under way to generate technologies to minimize reagent requirements.⁷

Point Detection Summary

Point detection technologies have shown promise of providing detect-to-warn (DTW) capability, both within a building and outside a facility. Although the aerosol background in both scenarios fluctuates significantly, as highlighted in Chapter 3, the committee believes these systems provide significant value. The size, shape, and fluorescent properties of background particles can be characterized, and their fluctuations modeled and histories incorporated into the analysis algorithm, so as to minimize their effects on the system.

⁶ V. Foot, Dstl. Presentation to the committee on April 15, 2002.

⁷ Foot, 2002. See note 6 above.

Point detection systems present less of a manufacturing challenge than the larger and more powerful standoff detection systems, discussed below. Aerosol particle counting systems are commercially available but on their own do not provide the fidelity of information required for detection of biological components. However, further information regarding particle shape can be obtained without the incorporation of additional laser sources. If additional laser sources are used, the absorption and fluorescence properties of biological material can be exploited to yield a system with rapid detection and a much lower false alarm rate. The key enabling technology appears to be low-cost, robust ultraviolet sources (e.g., light emitting and laser diodes), which are being pursued in ongoing DARPA-funded research programs.

Of the two scenarios considered in this report (internal and external release), the point detection capability is best suited for detection of an internal release of biological agent. One reason is that the internal concentration of biological aerosol particles is likely to be higher for a longer period after the release due to the limited air volumes in enclosed spaces and the lack of weather. A second major distinction between the two scenarios is the fluctuation of the background environments. The fluctuations are frequently associated with discrete events such as people entering or leaving a room.⁸ Such events and associated fluctuations can be incorporated into an analysis system to normalize the values. Background fluctuations in the outside release scenario are less predictable and therefore harder to normalize. Accurate detection will require protocols for minimizing extraneous aerosols.

STANDOFF DETECTION TECHNOLOGIES

Standoff detection technology relies on the measurement of energy transmission through the atmosphere to detect and distinguish biological agents from other atmospheric pollutants.⁹ The atmosphere has two main components: the molecular atmosphere (primarily oxygen and nitrogen) and aerosol particles, with the concentration of the latter being highly variable on a short time scale.¹⁰ Laser remote sensing, known as light detection and ranging (lidar) has been used successfully for years to detect and measure atmospheric properties of both gases and particulates.¹¹ One of the major limitations to remote sensing is the variable transparency of the atmosphere to transmitted light of different wavelengths. There is significant atmospheric absorption of the light by the various gases in the atmosphere, as well as scattering of light by natural aerosols.

Figure 5.2 shows the vertical spectral transmittance from the top of the atmosphere to ground level.¹² Similar spectral trends are expected for the actual transmittance paths and distances used in biological standoff detection, though the actual transmittance values will be different and depend on the details of the observation path. Transmittance may be reduced due to the presence of pollen, fungi, protozoa, bacteria, viruses, particulate matter, and chemicals from plants, soils, farming, human and animal activity, industrial pollution, and pollution from internal combustion engines.¹³ Airborne organic pollutants can

⁸ There are exceptions, such as sites where environmental growth of organisms is occurring or where water spray devices are operating.

⁹ NIJ, 2001. See note 3 above.

¹⁰ M.D. Roberts. 2001. Atmospheric analysis techniques at HiRes. Proceedings of the International Cosmic Ray Conference, 645-648.

¹¹ Chemical and Biological Defense Information Analysis Center (CBIAC). 2001. Artemis Analysis of Alternatives Final Report. Aberdeen Proving Ground, Md.: CBIAC.

S.N. Mikhailenko, V.L.G. Tyuterev, V.I. Starikov, K.K. Albert, B.P. Winnewisser, M. Winnewisser, G. Mellau, C. Camy-Peyret, R. Lanquetin, J.M. Flaud, and J.W. Brault. 2002. Water spectra in the region 4200-6250 cm^{-1} : Extended analysis of $\nu_1 + \nu_2$, $\nu_2 + \nu_3$, and $3\nu_2$ and bands and conformation of highly excited states from flame spectra and from atmospheric long-path observations. *Journal of Molecular Spectroscopy* 213:91-121.

M. Sasano, N. Hayashida, T. Minagawa, M. Teshima, T. Yamamoto, M. Chikawa, Y. Morizane, K. Yasui, S. Kawakama, P. Sokolsky, L. Wiencke, and M. Roberts. 2001. Atmospheric monitoring in Utah using the back scatter lidar method. Proceedings of International Cosmic Ray Conference, 653-656.

¹² G. Guyot. 1998. *Physics of the Environment and Climate*. New York: John Wiley & Sons.

¹³ P. Biggins, Dstl. Presentation to the committee on April 15, 2002.

J. Ho, P. Hairston, and M. Spence. 2001. Biological Detector Performance with a 402 nm Laser Diode. DRES TR 2000-190.

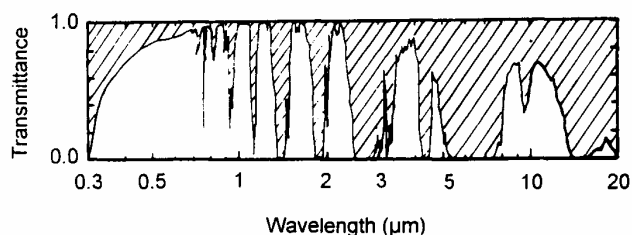

FIGURE 5.2 Mean spectral transmittance of the atmosphere between 0.2 and 20 μm .

react with ozone to form species that fluoresce broadly at 300 to 800 nanometers (nm) after excitation at short wavelength ultraviolet radiation.¹⁴

The concentrations and compositions of natural aerosols are variable, depending on the part of the world, the season, meteorological conditions, solar flux, and time of day (see

Chapter 3). There are diurnal and annual cycle variations, especially in amounts of airborne, culturable bacteria.¹⁵ Not all of the airborne bacteria are culturable; one estimate suggested that less than 10 percent can be cultured. Of those cultured, approximately 28 percent are not identifiable and 31 percent are from the genus *Bacillus*.¹⁶ For one set of outdoor measurements, the average outdoor background in an urban area varies from 10^1 to 10^4 organisms per liter, depending on the time of day.¹⁷

All aerosol particles in the atmosphere illuminated by light both absorb and scatter that energy, diminishing the energy of the incident light. The attenuation process or extinction measured is concerned with attenuation along the optical path. Scattering from molecules in the air is known as Rayleigh scattering, while scattering from aerosol particulates is Mie scattering.¹⁸ Scattering is a function of the ratio of the molecular or particle diameter to the wavelength of incident light; all aerosol particles will scatter light, but absorption can occur only at specific wavelengths at which electronic transitions can occur in the absorbing species.¹⁹

Standoff detection systems use lasers to illuminate the biological agent aerosol cloud. The incident laser pulse will undergo elastic Mie scattering, with some of the energy being back-scattered to the laser receiver, giving rise to so called elastic backscatter lidar. In this case, the amplitude of the return signal is proportional to the number of aerosol particles present, and the time delay of the return signal with respect to the original laser pulse yields the distance of the cloud. In those cases where the wavelength of the laser pulse corresponds to an absorption band in the aerosol, some of the laser energy will be absorbed and can then be reemitted at a different wavelength characteristic of the chemical composition of the aerosol (fluorescence). This is the basis of laser-induced fluorescence lidar. Elastic backscatter lidars typically operate in the infrared (1 to 10 μm), while ultraviolet-laser-induced fluorescence lidars (UV-LIF) typically operate at wavelengths of 200 to 400 nm.²⁰ The Department of Defense is currently pursuing an elastic backscatter lidar to detect suspicious aerosol clouds out to distances up to 50 kilometers and a UV-LIF lidar to then interrogate these clouds at distances of several kilometers to determine whether they contain significant amounts of biological aerosols. These and other remote sensing systems are described in the sections below.

Suffield, Canada: Defence Research Establishment Suffield.

S.R. Long, U.S. Army. Presentation to the committee on April 15, 2002.

¹⁴ NIJ, 2001. See note 3 above.

¹⁵ Long, 2002. See note 13 above.

Biggins, 2002. See note 13 above.

¹⁶ Long, 2002. See note 13 above.

¹⁷ Biggins, 2002. See note 13 above.

¹⁸ Guyot, 1998. See note 12 above.

¹⁹ V. Butalov, M. Fischer, and I. Schecter. 2002. Aerosol analysis by cavity-ring-down laser spectroscopy. *Analytica Chimica Acta* 466:1-9.

²⁰ NIJ, 2001. See note 3 above.

G. Rubel, U.S. Army. Presentation to the committee on April 15, 2002.

Ultraviolet Systems

An ultraviolet lidar system that causes amino acids and other biomolecules present in biological materials to fluoresce is currently under development by the DoD Program Executive Office (BioDefense) (PEO-BD).²¹ In one implementation, a short-range UV-LIF lidar actively irradiates a suspected biological agent aerosol cloud with light at 280 nm; the induced fluorescence return is measured at 350 nm. This methodology is based on conventional analytical techniques historically used to measure protein concentration.²² Tyrosine, tryptophan, and phenylalanine, which are present in the cell material of all biological organisms and the cell wall of bacterial spores, all absorb energy between 260 and 280 nm. The fluorescence signal seen is from the amino acid tryptophan, which absorbs strongly at 280 nm and fluoresces at 348 nm.²³

A short-wavelength UV-LIF system (e.g., 260 to 280 nm) is likely to be most effective at night or during low light periods because of the relative opacity of the air to these wavelengths and to the high ultraviolet background during the day. It is important to note that the UV-LIF does work for standoff detection during daylight hours, but its range is not as great as during nondaylight hours. For this reason, the design of any battlefield defensive architecture should be preceded by a significant amount of systems analysis to examine possible architectures, their cost-benefit trade-offs, and their concept of operations. Addition of longer wavelength excitation may extend the daytime range and provide additional spectral information to aid in the discrimination of clouds of biological agents. A 355-nm excitation wavelength causes reduced nicotinamide adenine dinucleotide (NADH) to fluoresce. The resulting spectrum has a maximum at approximately 475 nm, although the fluorescence emission is quite broad, spread from 400 nm to 525 nm.²⁴ Using a 400 nm excitation wavelength causes fluorescence in riboflavin; that emission is centered around 525 nm (see Figure 5.3).²⁵

The advantage of a UV-LIF system over an IR system is that it can detect fluorescence emissions in wavelength regions characteristic of biological molecules such as riboflavin and therefore can distinguish a biological aerosol from nonbiological particulates. It is available now as a prototype and it has been demonstrated to detect biological aerosols up to approximately 1 kilometer away.²⁶ Selection of the appropriate excitation wavelength depends on the species being interrogated as well as the desired range. Backscatter intensity is greater at shorter wavelengths, but so is atmospheric attenuation. The net effect is that maximum ranges are reduced for shorter wavelengths.²⁷ For 355 nm wavelengths, the range can be 2 to 4 kilometers. There are other systems used for meteorological observation that employ three wavelengths (355 nm, 532 nm, and 1064 nm), with reported ranges up to 10 kilometers.²⁸

UV-LIF may not specifically distinguish biological agents from other biological material; a fluorescence response at 350 nm after excitation at 260-280 nm only means that protein with tryptophan is probably present. It is not an indication of living organisms, nor is it necessarily distinctive of bacteria. In principle, a fluorescence peak centered at 475 nm after excitation at 355 nm, which is attributed to NAD(P)H, could be used to distinguish living from dead bacteria. As bacteria die, their NAD(P)H becomes oxidized to NAD, so this peak could indicate living organisms. However, there are conflicting reports about the source of the fluorescence from irradiation at 355 nm; some researchers²⁹ suggest that

²¹ Rubel, 2002. See note 20 above.

²² Ho et al., 2001. See note 13 above.

²³ A.L. Lehninger. 1975. *Biochemistry*. New York: Worth Publishers, Inc.

CBIAC. 1995. *State of the Art Report: Biological Warfare Agent Detection Technologies*. Aberdeen Proving Ground, Md.: CBIAC.

²⁴ Ho et al., 2001. See note 13 above.

²⁵ Ho et al., 2001. See note 13 above.

²⁶ Rubel, 2002. See note 20 above.

²⁷ CBIAC, 2001. See note 11 above.

²⁸ EARLINT. 2000. *A European Aerosol Research LIDAR Network to Establish an Aerosol Climatology*. Handbook of Instruction, Max-Planck-Institut für Meteorologie, Hamburg, Germany. Available at <http://LIDARb.dkrz.de/earlinet/handbkinstr.pdf>.

²⁹ J.D. Eversole, W.K. Cary, Jr., C.S. Scotto, R. Pierson, M. Spence, and A.J. Campillo. 2001. Continuous bioaerosol monitoring

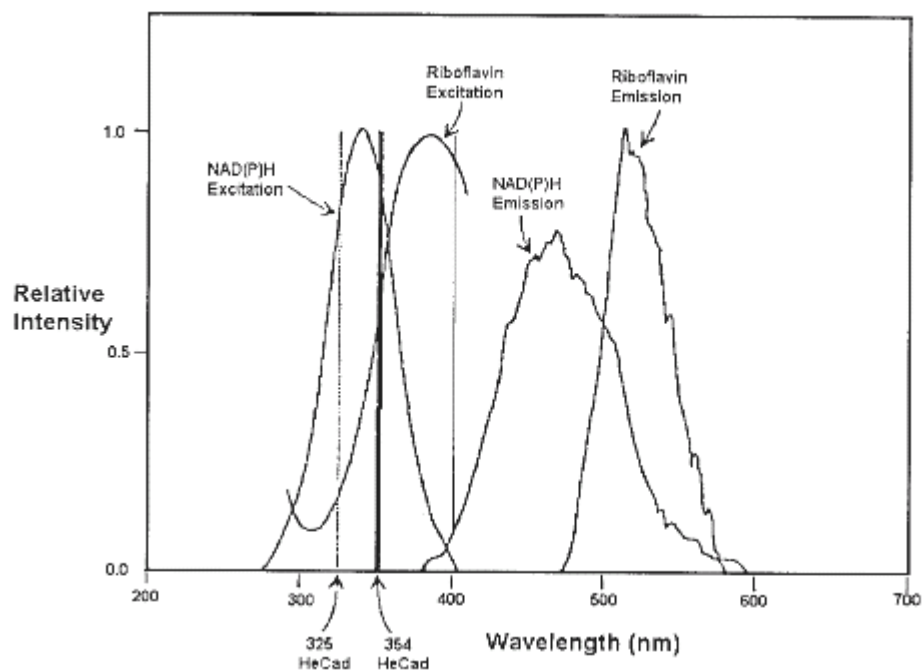

FIGURE 5.3 Excitation and emission spectra of two biomolecules associated with cellular metabolism.

the fluorescence is from NAD(P)H or flavins. Other reports propose that the fluorescence is from growth media, which contains proteins, or at least peptides.³⁰ The fluorescence return from irradiation at 260-280 nm is more intense than the return from irradiation at 355 nm; shorter wavelength (and higher energy) photons excite more molecules.³¹ However, this more energetic return is offset by atmospheric degradation.³²

Standoff Detection Summary

The reported effective nighttime ranges for UV-LIF prototype systems operating at 260-280 nm excitation wavelength are approximately 1 km, using approximately 1,000 particles per liter in a clear atmosphere (visibility 23 km) as the detection limit.³³ Projected ranges for a comparable system operating at excitation wavelengths of 355 nm are 2 to 4 kilometers, with sensitivity limits of hundreds of particles per liter of air.³⁴

While UV-LIF systems do allow the discrimination of biological from nonbiological aerosols, they have several shortcomings. They have a shorter range than infrared-based systems, because the shorter ultraviolet wavelengths are more attenuated by the atmosphere.³⁵ They are nonspecific in that they

using UV excitation fluorescence: Outdoor test results. *Field Analytical Chemistry and Technology* 15:205-212.

Jim Ho. 2002. Future of biological aerosol detection. *Analytica Chimica Acta* 457:127-150.

Ho et al., 2001. See note 13 above.

³⁰ CBIAC, 2001. See note 11 above.

³¹ P. Hairston and J. Ho, Defense Research Establishment Suffield, Canada. Biological particle discrimination based on individual particle measurements using near UV fluorescence excitation. Presentation to the committee on April 15, 2002.

³² Hairston and Ho, 2002. See note 31 above.

CBIAC, 2001. See note 11 above.

³³ Hairston and Ho, 2002. See note 31 above.

Rubel, 2002. See note 20 above.

³⁴ John Vitko, Department of Homeland Security. 2002. Discussions with the committee.

³⁵ CBIAC, 2001. See note 11 above.

cannot identify the specific biological organism or discriminate nonpathogenic from pathogenic.³⁶ Further, the source of the fluorescence signal is uncertain.³⁷ There may be some backscatter signals from natural aerosols that could interfere with the detection. It is unlikely that chemicals present in the atmosphere interfere, since they do not fluoresce as efficiently as particles.³⁸

NOVEL OR ADVANCED STANDOFF DETECTION TECHNIQUES

The Department of Defense is conducting basic and applied research into a broad range of electromagnetic techniques to see whether they have the potential for extending the detection range and increasing the specificity for remote detection of biological agents. At this writing, they are all in the early research stage and require significant laboratory analysis and systems modeling before they would warrant moving to a breadboard stage. Representative examples of these novel approaches are given below.

Ultraviolet Resonance Raman Spectroscopy

In this technique, ultraviolet light is used to enhance Raman spectral lines at wavelengths corresponding to electronic vibrational mode transitions of the target molecule.³⁹ In the laboratory, this ultraviolet resonance Raman (UVRR) technique uses ultraviolet energy to excite DNA⁴⁰ or protein amino acids⁴¹ to excited state saturation, then measures the Raman spectral shift. The UVRR shift is usually measured in the range of 600 to 1,800 per centimeter, using conventional ultraviolet-visible IR instruments.⁴² The method has a distinct advantage over conventional Raman spectroscopy in that emission intensity is enhanced by a factor of 10^3 to 10^6 .⁴³ Additionally, UVRR reduces the complexity of peptide and protein Raman spectra because it selectively enhances only a few of the first excited state vibrational transition modes.⁴⁴ Consequently there are fewer spectral lines for analysis. Further, the spectral bands are much narrower (~10 per centimeter) than usually seen with absorption spectroscopy, with little overlap. Resonant Raman scattering is limited to those vibrational modes for which the excited state is in resonance with the excitation wavelength.⁴⁵ Use of ultraviolet excitation wavelengths below

³⁶ CBIAC, 2001. See note 11 above.

Rubel, 2002. See note 20 above.

³⁷ Ho, 2002. See note 29 above.

³⁸ A number of polyaromatic hydrocarbons do fluoresce, and the potential of these compounds to interfere in the analysis should be studied further.

CBIAC, 2001. See note 11 above.

³⁹ Q. Wu, W.H. Nelson, S. Elliot, J.F. Sperry, M. Feld, and R. Manoharan. 2000. Intensities of *E. coli* nucleic acid Raman spectra excited selectively from whole cells with 251 nm light. *Anal. Chem.* 72:2981-2986.

Q. Wu, T. Hamilton, W.H. Nelson, S. Elliot, J.F. Sperry, and M. Wu. 2001. UV Raman spectral intensities of *E. coli* and other bacteria excited at 228.9, 244.0, and 248.2 nm. *Anal. Chem.* 73(14):3432-3440.

⁴⁰ Wu et al., 2000. See note 39 above.

⁴¹ S.P.A. Fodor, R.P. Rava, T.R. Hays, and T.G. Spiro. 1985. Ultraviolet resonance Raman spectroscopy of the nucleotides with 260-, 240-, 2180, and 2-nm pulsed laser excitation. *J. Am. Chem. Soc.* 107:1520-1529.

P.A. Harmon, J. Teraoka, and S.A. Asher. 1990. UV resonance Raman saturation spectroscopy measures protein aromatic amino acid excited state relaxation rates. *J. Am. Chem. Soc.* 112:8789-8799.

J. Teraoka, P.A. Harmon, and S.A. Asher. 1990. UV resonance Raman saturation spectroscopy of tryptophan derivatives: Photophysical relaxation measurements with vibrational band resolution. *J. Am. Chem. Soc.* 112:2892-2900.

⁴² X.G. Chen, S.A. Asher, R. Sweitzer-Stenner, N.G. Mirkin, and S. Krimm. 1995. UV Raman determination of the $\pi \pi^*$ excited state geometry of N-methylacetamide: Vibrational enhancement pattern. *J. Am. Chem. Soc.* 117:2884-2895.

Z.Q. Wen, S.A. Overman, G.J. Thomas. 1997. Structure and interactions of single-stranded DNA genome of filamentous virus *fd*. investigation by ultraviolet resonance Raman spectroscopy. *Biochemistry* 36:7810-7820.

⁴³ H.A. Strubel and W.R. Heineman. 1989. *Chemical Instrumentation: A Systematic Approach*. New York: John Wiley & Sons.

D.P. Strommen. 1997. Raman Spectroscopy. In *Handbook of Instrumental Techniques for Analytical Chemistry*. F.A. Settle, ed. Upper Saddle River, N.J.: Prentice-Hall.

⁴⁴ R. Schweitzer-Stenner. 2001. Visible and UV-resonance Raman spectroscopy of model peptides. *J. Raman. Spectrosc.* 32:711-732.

⁴⁵ H. Tyakuechi, M. Matsuno, S.A. Overman, and G.J. Thomas, Jr. 1996. Raman linear intensity difference of flow-oriented macromolecules: Orientation of the indole ring of tryptophan-26 in filamentous virus *fd*. *J. Am. Chem. Soc.* 118:3498-3507.

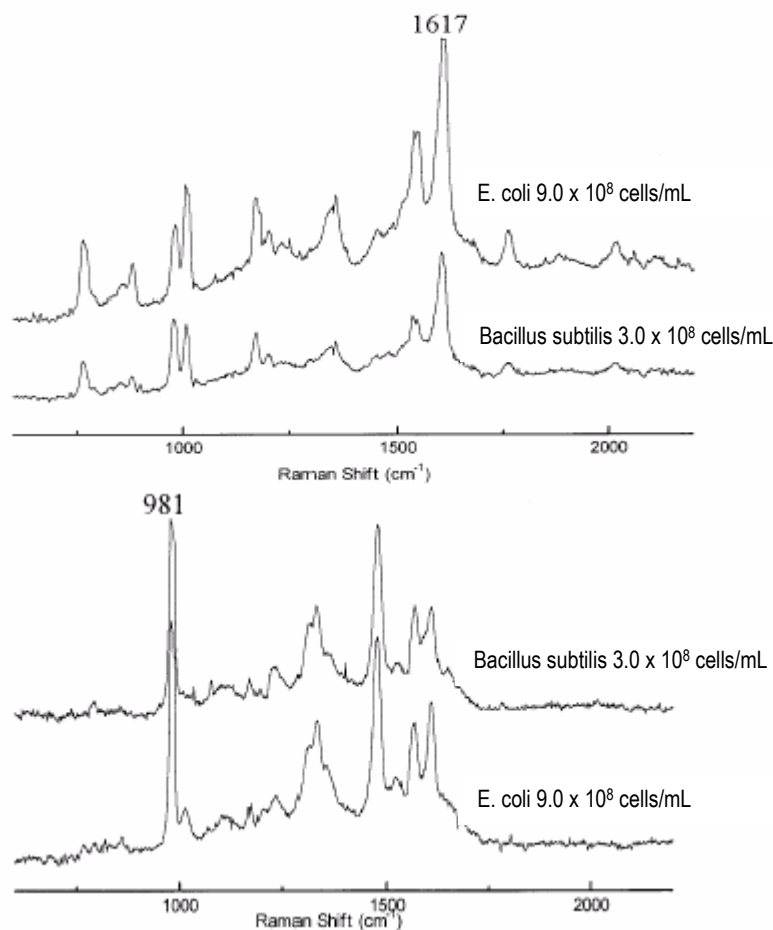

FIGURE 5.4 Different intensities of UV resonance Raman spectral shift from *E. coli* and *B. subtilis*.

257 nm results in very little fluorescence interference, but these shorter wavelengths propagate even less than the 260 to 280 nm wavelengths discussed above.⁴⁶

Preliminary results⁴⁷ suggest that it may be possible to distinguish different bacterial genera by the differences in intensity of Raman emissions at a specific spectral peak position. Using 228.9 nm as the excitation wavelength results in identical Raman peaks for all genera observed (*E. coli*, *B. subtilis*, *C. freundii*, *E. aerogenes*, *S. epidermidis*), but with significant differences in the intensities for different organisms. Figure 5.4 shows this difference in intensity.

Although there are significant differences in the peak intensities between the two organisms whose spectra are shown in Figure 5.4, at least some of the difference can be attributed to conditions under which the organisms were grown.⁴⁸ Furthermore, such intensity differences cannot be used to distinguish between species unless there is some other information that provides their concentration levels.

⁴⁶ Wu et al., 2000. See note 39 above.

⁴⁷ Wu et al., 2001. See note 39 above.

⁴⁸ Wu et al., 2000, 2001. See note 39 above.

Other Ultraviolet Systems

One of the near-term approaches is to match a short-range UV lidar system with a long-range IR lidar. This hybrid system is the basis for the DoD's Joint Biological Standoff Detection System.⁴⁹ The IR lidar will detect a possible biological agent cloud at a greater distance than the UV lidar. Once the particulate cloud is detected, the UV lidar can be used to indicate whether or not the cloud is biological.⁵⁰ However, this still does not determine whether a biological agent is present. Further, much more work is needed on the concepts of operation that prescribe how the system will be employed or what the response will be to positive alarms.

Because of the high and highly variable biological background, there may be a high false alarm rate; for example, when the dew point is reached, there can be a nearly instantaneous release of spores from fungi that mimics very closely a typical biological attack. Such natural releases can cause a rapid increase in the bioaerosol background by 10^4 particles per liter (see Chapter 3). Such false alarms can be reduced through study and modeling of the fluctuations of the natural background under various conditions and use of appropriate computer algorithms to normalize the detector signal.

TERAHERTZ SPECTROSCOPY

There is little information available concerning terahertz technologies for biological agent aerosol detection. Reportedly, the spectra obtained are high in information content but very difficult to interpret because of the low absorption cross sections.⁵¹

While point detection systems for particles are commercially available and relatively inexpensive, the point detection systems that can discriminate biological particles require significantly more sophisticated hardware and manufacturing. These systems are commercially available and undergoing continual refinement. The shift from point to standoff detection requires significant increases in sophistication of both hardware and software. Prototype systems exist in a variety of laboratories around the world, but this remains basically a research area. Progress has been made in the laser sources for these systems, allowing for greater strength of signal in an atmospheric window. These advances will increase both sensitivity and range of standoff systems.

One of the most important issues for standoff systems is the generation and acceptance of a usage doctrine for this projected capability. Without a clear understanding of the requirements and subsequent benefits, it is difficult to assess the major manufacturing challenges for these systems. Most likely challenges will be in the areas of improved laser sources and data acquisition and processing of the returned signal.

FINDINGS AND RECOMMENDATIONS

Spectroscopic Point Detectors

Finding 5-1a: Spectroscopic point detectors based only on aerosol particle counting with size discrimination are likely to yield an unacceptable rate of false positive alarms if they are used by themselves as the first stage in a detect-to-warn sensor system.

Although the information provided by these detectors is accurate and rapid, they are unable to distinguish between an increase in the number of particles due to biological agent attack and an increase caused by normal fluctuations in background particles in the 1 to 10 μm diameter range.

Finding 5-1b: Point detection systems using both particle size and shape analysis as well as UV-LIF as

⁴⁹ DoD. 2002. Joint Service Chemical and Biological Defense Program, FY 02-03 Overview. Washington, D.C.

⁵⁰ David Walt, Tufts University. Presentation to the committee on June 12, 2002.

⁵¹ Rubel, 2002. See note 20 above.

a detector of biologically relevant material have the greatest promise for rapid detection using existing technology. This type of system is most valuable when used within buildings, where the fluctuations in background may be mitigated by filtering and also by smart algorithms that correlate remaining fluctuations with factors such as changes in building occupancy and cleaning.

Recommendation 5-1: Combination (particle characterization technology and UV-LIF) detectors should be developed and fielded as rapidly as possible to provide a detect-to-warn capability for high-value buildings, especially when low-regret responses are available (see Chapter 10). Studies should be performed to characterize the false positive rates of these enhanced bioaerosol detectors at a variety of detection thresholds, including the higher concentrations expected for many building scenarios.

Finding 5-2: The oxidation level of organisms, as determined by the NAD(P)H fluorescence, is a potentially exploitable signature to provide information on their viability in near real time. Viability and discrimination information can also be obtained by making determinations of the cellular ATP levels of collected samples. Currently this latter assay takes minutes and requires a relatively concentrated sample. The spectral combination of size, biological content, and viability in near real time will significantly increase the detect-to-warn capability.

Recommendation 5-2: Further research should be supported to exploit the detection of oxidative state and ATP levels of organisms as indicators of their viability.

Standoff Detectors

Finding 5-3a: Active infrared lidar systems offer the greatest range (and hence the greatest warning time) for detection of aerosol clouds in the atmosphere but do not distinguish biological from nonbiological particles. They also have a significant potential for false alarms due to fluctuations in the concentration of particulate matter in the atmosphere.

Finding 5-3b: Short-range use of UV-LIF provides near-real-time discrimination of biological from nonbiological particles.

The ability to use shorter excitation wavelengths for short distances where atmospheric propagation is not an issue allows information-containing spectral properties to be gathered from aerosolized particles. Current operational systems employ temporal comparisons of spectral signatures to decrease false positive readings due to fluctuations in background signatures.

Finding 5-3c: There is no currently fielded standoff biological agent aerosol detection capability, nor is there a clear concept of operations for use of such a system. The technology closest to fielding is the Joint Biological Standoff Detection System.

Recommendation 5-3: A clear concept of operations for IR-UV-LIF hybrid systems should be developed, and, if promising, development of such a system should be expedited to provide an interim warning capability against biological aerosol attack on extended facilities. Expedite development and fielding of a system such as the JBSDS.

Finding 5-4: There is no currently fielded standoff capability to identify threat biological agents once a biological aerosol has been detected. This is a highly desirable capability that would reduce false alarms from the large amounts of biological material normally present in the atmosphere.

Recommendation 5-4: Laboratory investigations into techniques that might extend the range or increase the specificity of biological standoff detection should be performed. Modeling should be used to understand the performance of the more promising techniques in realistic simulations of standoff applications (e.g., multicomponent clouds with possible interferences). If the new techniques pass the modeling and simulation test, consider moving on to prototyping.

Finding 5-5: There are technologies and systems currently in use by meteorologists and atmospheric scientists that are similar to those developed by the Department of Defense.

Recommendation 5-5: Close monitoring and evaluation should continue of instrumentation, technologies, and techniques (especially those in ultraviolet systems) used in atmospheric studies to determine their applicability to DoD systems.

6

Nucleic Acid Sequence-Based Identification for Detect-to-Warn Applications

Culture-based assays, which typically run for 12 to 24 hours or longer, are normally viewed as an unimpeachable standard for the identification (ID) of microbes. However, nucleic acid-based assays offer a relatively faster response time combined with high sensitivity and specificity, and this has catapulted them to the forefront for laboratory analysis and, in some cases, field analysis. The sequence of nucleic acids has been successfully used in laboratory settings to identify both nonpathogenic¹ and pathogenic bacteria.² Similar studies of microbial diversity have been performed using ribosomal RNA methods.³

It is the view of this committee that sequence-based ID using nucleic acid assays will play a critical role in any defensive architecture against biological agent attack, to confirm whether or not an attack has occurred and if it has, what types of biological agents were used.⁴ This confirmatory role is essential even if the response time of the assay is relatively slow—on the order of 15-30 minutes. This chapter examines whether DNA or RNA sequence-based detection and ID assays can be accelerated to provide a detect-to-warn capability with a response time on the order of 1 minute starting from aerosolized agent—and if so, how much specificity and sensitivity must be sacrificed in limiting the duration of the process and in automating the overall procedures for unattended field operation.

As discussed in Chapter 1, the sequence of processes that must be included within this response time is as follows:

- Collecting the sample.
- Preparing the sample for analysis. This includes removal of assay inhibitors and lysis of the target cells. For dirty samples or for nucleic acid analysis of a spore, these can be significant problems.
- Performing the assay itself.
- Analyzing and reporting the results of the assay.

¹ K.E. Nelson, I.T. Paulsen, J. F. Heidelberg, and C.M. Fraser. 2000. Status of genome projects for nonpathogenic bacteria and archaea. *Nature Biotechnology* 18:1049-1054.

² L. Radnedge, S. Gamez-Chin, P.M. McCreedy, P.L. Worsham, and G.L. Andersen. 2001. Identification of nucleotide sequences for the specific and rapid detection of *Yersinia pestis*. *Appl. and Env. Microbio.* 67:3759-3762.

³ Susan M. Barns, C.F. Delwiche, J.D. Palmer, and N.R. Pace. 1996. Microbiology perspectives on archaeal diversity, thermophily and monophyly from environmental rRNA sequences. *Proc. Natl. Acad. Sci.* 93:9188-9193.

⁴ It is important to note that nucleic acid sequence-based detection would not detect molecular toxins.

At this writing, the committee is not aware of any existing nucleic acid analysis system that performs the full set of tasks described above for relevant aerosol concentrations of pathogenic organisms within the detect-to-warn time constraint of 1 minute. Presently, this type of multistep analysis is performed manually in laboratory settings by highly trained personnel and requires an hour or more to accomplish. Recent advances in the miniaturization of instrumentation, however, offer the possibility that such nucleic acid-based analysis protocols could be automated and performed in the field by dedicated stand-alone sensors, given much additional development.

This chapter describes representative present-day technologies that perform each of the functions listed above (in sequential order, as a sensor system would operate) and evaluates their potential for use in detect-to-warn applications. Aside from technological feasibility, other factors must also be considered: e.g., sensitivity, specificity, robustness to environmental contaminants, requirements for sample preparation, cost, storage and logistics, ease of implementation into field equipment, and level of multiplexing of the assays. The chapter concludes with the committee's key findings and recommendations.

SAMPLE COLLECTION

As with any other sensor methodology discussed in this report, a nucleic acid sensor would first need to collect an air sample of sufficient volume and pathogen density to be detectable in the assay. For most of the techniques described below, the assay is performed with the organism and target nucleic acid sequence in aqueous solution. Therefore, the air-collection devices (wetted-wall cyclones, air-to-air concentrators, etc.) described in Chapter 4 must convert the air sample to a fluid (hydrosol) and provide it to the assay instrumentation.

For nucleic acid-based detection and identification technologies, one can expect some trade-off between the time required for detection and the starting concentration. Rugged, field-tested aerosol collectors such as the XM-2 have been demonstrated to capture particles in the 1 to 10 μm range with an efficiency of 50 percent or higher, with an effective concentration factor on the order of 5×10^5 (that is, one captured particle per 500 liters of air is concentrated into 1 milliliter of collection fluid.) Bioaerosol collectors of even higher performance have been developed under the guidance of the U.S. Army Edgewood Chem-Bio Center (ECBC) at Aberdeen Proving Grounds.⁵

From the standpoint of system analysis for the detect-to-warn application, some miniaturization of the overall system dimensions will decrease the time required to transport and prepare the samples for their detection assays, so collection into 1 milliliter is probably less desirable than collection into a 100 microliter or smaller liquid volume. It is important to remember that decreasing the size of the system may lead to more rapid clogging of the fluidics, so that shorter maintenance intervals may be required with the reduction in system size. The same considerations apply to the use of multistage precollection fractionators that could provide concentration factors exceeding 10^6 ; improved overall performance is likely to come at the expense of more frequent maintenance.

SAMPLE PREPARATION

Nucleic acid amplification and analysis methods are sensitive to contamination by inhibitors, which can often accompany samples that are collected from the open environment. Furthermore, the nucleic acid of interest typically resides within a cell or spore and must be liberated or made available to the other chemical components of the assay. (While it is true that there is often some detectable, exogenous DNA that was trapped on or within the exosporium during the process of sporulation, assays based solely on this source of DNA may be less sensitive and less reliable.) For reliable assays based on nucleic acid sequences, other than assays that are intracellular, the nucleic acid must be separated from interfering or inhibiting components before the assay is performed.

⁵ E. Stuebing, U.S. Army. Discussions with the committee in 2003.

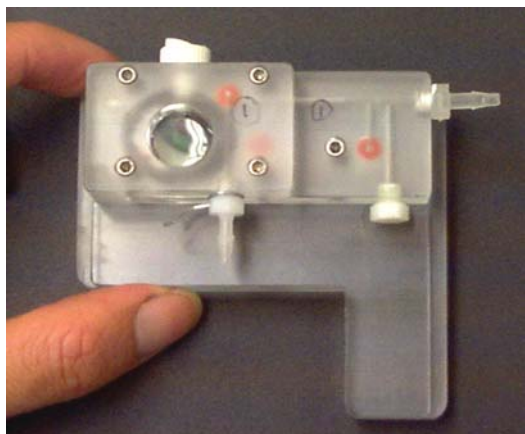

FIGURE 6.1 Cepheid ultrasonic fluidic component for lysing spores to get access to DNA.

A number of effective methods have been developed over the years to lyse cells and remove contaminants from samples. Cell lysis using chaotropic salts (e.g., guanidinium isothiocyanate) is one effective method and is often followed by capture of the DNA (and not the dirt) on some silica-based substrate under high-salt conditions.⁶ Once the dirt is washed away, the DNA is then eluted from the silica in a low-salt buffer and then analyzed. This and similar methods are available commercially, and they are often performed in plastic tubes using a centrifuge⁷ or vacuum or pressure to transport and process the samples. These commercial techniques, while effective, require between 30 minutes and 2 hours and are therefore not suitable, in the committee's view, for consideration for the detect-to-warn application.

Recently, the chemistry that is described in the patent by W. Boom has been implemented using microfabricated silica surfaces within microfluidic systems.⁸ The committee is not aware, however, of any studies on the rates or kinetics involved in the use of such microfluidic silica surfaces for the overall process of trapping, washing, and releasing nucleic acids from lysed bacteria. Using the chemistry of Boom, Ness and Belgrader have demonstrated the polymerase chain reaction (PCR) of *F. tularensis* spiked into raw sewage water, which normally inhibits any PCR.⁹

One rapid method to lyse cells, including spores—which are difficult to disrupt—is ultrasonication with glass or composite microbeads (Figure 6.1). This method has been shown to open spores in as little as 10 seconds¹⁰ and has been integrated into an existing commercial DNA analysis instrument (Figure 6.2).¹¹ This continues to be an area of



FIGURE 6.2 Arrays of microfabricated pillars with silica surfaces.

⁶ W.R. Boom, H.M.A. Adriaanse, T. Kievits, and P.F. Lens. August 10, 1993. Process for isolating nucleic acid. U.S. Patent 5,234,809.

⁷ Qiagen at <http://www.Qiagen.com> and MoBio at <http://www.Mobio.com>.

⁸ D.D. Hansmann, J.P. Grace, M.G. Lower, G.M. Oosta, N.W. Loomis, E.B. Shain, and T.G. Schapira. Devices and methods utilizing arrays of structure for analyte capture. January 13, 1998. U.S. Patent 5,707,799.

D.D. Hansmann, J.P. Grace, M.G. Lower, G.M. Oosta, N.W. Loomis, E.B. Shain, and T.G. Schapira. Devices and methods utilizing arrays of structure for analyte capture. September 14, 1999. U.S. Patent 5,952,173.

⁹ K. Ness and P. Belgrader, Lawrence Livermore National Laboratory. Unpublished data communicated to the committee in 2003.

¹⁰ P. Belgrader, W. Benett, D. Hadley, J. Richards, P. Stratton, R. Mariella, Jr., and F. Milanovich. 1999. PCR detection of bacteria in seven minutes. *Science* 284:449-450.

P. Belgrader, D. Hansford, G. Kovacs, K. Ventkateswaran, R. Mariella, Jr., F. Milanovich, S. Nasarabadi, M. Okuzumi, F. Pourahamadi, and M. Northrup. 1999. A minisonicator to rapidly disrupt bacterial spores for DNA analysis. *Anal. Chem.* 71:4232-4236.

¹¹ P. Belgrader, M. Okuzumi, F. Pourahamadi, D.A. Borkholder, and M.A. Northrup. 2000. A microfluidic cartridge to prepare spores

active research. For the purposes of this report, the committee expects that it will be possible to implement an ultrasonication procedure with a duration of 10 seconds. There are no data regarding the percent of DNA or RNA that will be released by this process, but a reasonable guess might be that roughly 30 percent of the nucleic acids from spores or vegetative bacteria could be released within a sample volume of 100 microliters or less (see Box 6.1).

In other research, a flow-through high-frequency lysis module has been demonstrated to release DNA from spores without the addition of microbeads or chemicals.¹² Processing without additives and in a flow-through manner will simplify integration with other sample processing modules and decrease cost due to consumables, which is important for detect-to-warn applications. The residence time of the continuously moving sample in the flow-through lysis module was not optimized; it ranged from about 10 to 60 seconds in the initial studies. The use of standing waves of ultrasound within a microfluidic channel has also been demonstrated to separate and concentrate particles that are suspended in an aqueous solution.¹³ This could be employed as a processing step within a detect-to-warn system.¹⁴

Methods for using electric fields to attract, focus, or separate bacteria, cells, and DNA in solution have been demonstrated and may work within time scales that have benefit for this application as well. The electrophoretic concentration and fractionation of bacteria are well documented in the literature. Typical electrophoretic mobility values for bacteria are on the order of 2×10^{-4} square centimeters per volt-second.¹⁵ A field strength of 100 volts per centimeter can result in an average velocity of 0.2 millimeter per second, which may be fast enough to be useful for detect-to-warn applications.¹⁶

The majority of biological particles are amphoteric; that is, they can be net negative, net positive, or net neutral, depending on the local pH. The pH at which a particle is neutral is called the isoelectric point (pI)—at this pH the particle experiences no net force when an electric field is applied. By generating a suitable pH gradient parallel to an electric field, particles in the field will migrate to their pI and remain fixed at that position. This technique has been used successfully to concentrate bacteria in flowing conditions.¹⁷

Finally, biological particles also become polarized when placed in an electric field. These induced dipoles can lead to net migration in an applied, nonuniform field, which is referred to as dielectrophoresis.¹⁸ The net velocity of a particle within such a nonuniform field depends on its dielectric

for PCR analysis. *Biosensors and Bioelectronics* 14:849-852.

M.T. Taylor, P. Belgrader, B.J. Furman, F. Pourahamdi, G.T.A. Kovacs, and M.A. Northrup. 2001. Lysing bacterial spores by sonication through a flexible interface in a microfluidic system. *Anal. Chem.* 73:492-496.

¹² D.P. Chandler, J. Brown, C.J. Bruckner-Lea, L. Olson, G.J. Posakony, J.R. Stults, N.B. Valentine, and L.J. Bond. 2001. Continuous spore disruption using radially focused, high-frequency ultrasound. *Anal. Chem.* 73:3784-3789.

¹³ H. Wang, J. Li, H. Liu, Q. Liu, Q. Mei, Y. Wang, J. Zhu, N. He, and Z. Lu. 2002. Label-free hybridization detection of a single nucleotide mismatch by immobilization of molecular beacons on an agarose film. *Molecular and Cellular Probes* 16:119-127; C. Lowe, University of Cambridge. Presentation to the committee on September 26, 2002.

M. McDonnell, Dstl. Presentation to the committee on June 12, 2002.

¹⁴ K. Yasuda, M. Kiyama, and S. Umemura. 1996. Deoxyribonucleic acid concentration using acoustic radiation force. *J. Acoust. Soc. Amer.* 99:1248-1251.

K. Yasuda, S. Umemura, and K. Takeda. 1996. Particle separation using acoustic radiation force and electrostatic force. *J. Acoust. Soc. Amer.* 99:1965-1970.

K. Yasuda, S.S. Haupt, S. Umemura, T. Yagi, M. Nishida, and Y. Shibata. 1997. Using acoustic radiation force as a concentration method for erythrocytes. *J. Acoust. Soc. Am.* 102:642-645.

¹⁵ A. Pfetsch and T. Welsch. 1997. Determination of the electrophoretic mobility of bacteria and their separation by capillary zone electrophoresis. *Fresenius J. Anal. Chem.* 359:198-201.

¹⁶ Even in a microfluidic environment, high fields will require relatively high voltages and may cause electrolysis of the water. Electrolysis can lead to bubbles that will interfere with the desired transport processes.

¹⁷ C.R. Cabrera and P. Yager. 2001. Continuous concentration of bacteria in a microfluidic flow cell using electrokinetic techniques. *Electrophoresis* 22(2):355-362.

¹⁸ P.R.C. Gascoyne and J. Vykoukal. 2002. Particle separation by dielectrophoresis. *Electrophoresis* 23(13):1973-1983.

A. Pohl. 1978. *Dielectrophoresis*. Cambridge, U.K.: Cambridge University Press.

M.S. Talary, K.I. Mills, T. Hoy, A.K. Burnett, and R. Pethig. 1995. Dielectrophoretic separation and enrichment of CD34+ cell subpopulation from bone marrow and peripheral blood stem cells. *Med. Biol. Eng. Comput.* 33(2):235-237.

G.H. Marx, P.A. Dyda, and R. Pethig. 1996. Dielectrophoretic separation of bacteria using a conductivity gradient. *J. Biotech.* 51:175-180.

Box 6.1**Three-Minute Detection and Identification System Based on PCR**

Below, the committee outlines a detection system that is only slightly beyond what has already been demonstrated in controlled laboratory settings. The committee is relatively confident that a system could be produced that would be able to perform a single-target (selectable), real-time PCR assay within 3 minutes, starting with the collection of an aerosol sample. There are no data that would allow an extrapolation of such a system to the use of a deeply multiplexed (15 target organisms) PCR assay with any confidence.

The assay proceeds through the following steps, with a time budget of 180 seconds: sample collection, sample preparation, performance of an assay, and analysis and reporting.

- Use 20 seconds to collect a sample from the air into an aqueous solution, using a collector with a two-stage, precollection fractionator possessing an overall capture efficiency of 50 percent and a collection rate of 90 liters of air per minute into 50 microliters of aqueous volume; 100 spores per liter of air would produce 1,500 spores in the 50 microliters of solution.
- Use 10 seconds to extract 25 microliters of the solution for analysis, archiving the remaining 25 microliters and/or providing it for parallel assays.
- Ultrasonicate for 20 seconds to get access to the nucleic acids inside the spores. Assume access is gained to 80 percent of the DNA. With a single copy of the genome per bacterium, there are 600 target sequences.
- For 20 seconds, use a pressure-driven or electrophoretic or other voltage-driven transport mechanism to move the DNA onto a sample preparation surface. About 80 percent of the DNA is estimated to be captured onto a silica-pillar preparation surface, 480 copies.
- For 10 seconds, wash the captured DNA and then release it.
- For 20 seconds, use pressure to move the DNA with master mix and fluorogenic probe into a 5-microliter chamber of a thermal cycler. In its purified and concentrated form, assume 80 percent of the DNA reaches the thermal cycler, 384 copies.
- Perform eight cycles at 10 seconds per cycle, assuming an optimized, high-performance thermal cycler. After these 80 seconds, 128×384 copies = 49,152 copies of the target will have been created.
- No wash step is required, and the fluorescent readout occurs within a second per cycle.

function relative to that of the surrounding media as well as on the frequency and strength of the applied electric field. In batch mode, cells can travel at velocities up to 0.1 millimeter per second.¹⁹ Early prototypes of dielectrophoresis-based devices can be rather small and simple in appearance (Figure 6.3).

Y. Huang, J. Yang, X.B. Wang, F.F. Becker, and P.R. Gascoyne. 1999. The removal of human breast cancer cells from hematopoietic CD34+ stem cells by dielectrophoretic field-flow-fractionation. *J. Hemat. Stem Cell Res.* 8:481-490.

T. Schnelle, T. Muller, R. Hagedorn, A. Voight, and G. Fuhr. 1999. Single micro electrode dielectrophoretic tweezers for manipulation of suspended cells and particles. *Biochem. Biophys. Acta* 1428(1):99-105.

H. Morgan, M.P. Hughs, and N.G. Green. 1999. Separation of submicron bioparticles by dielectrophoresis. *Biophysical Journal* 77:516-525.

T. Schnelle, T. Muller, G. Gradl, S.G. Shirley, and G. Fuhr. 2000. Dielectrophoretic manipulation of suspended submicron particles. *Electrophoresis* 21:66-73.

R. Miles, P. Belgrader, K. Bettencourt, J. Hamilton, and S. Nasarabadi. 1999. Dielectrophoretic manipulation of particles for use in microfluidic devices. *J. Microelectromechanical Systems* 1:497-501.

¹⁹ J. Schwartz. 2002. Discussions with the committee.

NUCLEIC ACID ASSAYS

Assays based on nucleic acid sequencing can be divided into two main groups:

- Group I: techniques that use amplification of one or more target sequences of the nucleic acid (RNA and DNA require different protocols) and
- Group II: techniques that do not use amplification of the nucleic acid.

The following sections describe assays in each category, with specific comments on the potential for detect-to-warn applications. For each of the techniques described, there may be multiple methods to detect the presence of the target sequence(s). These may be based on use of fluorescent labels, chemiluminescent reporters, colorimetric labels, mass-spectrometric tags, or other sensing means. The committee tried to consider and describe the tagging or sensing methods that seem most useful for rapid detection and to identify areas in which further improvements in speed and sensitivity are required in order to enhance the potential of the technology for detect-to-warn applications.

Both Group I and Group II techniques can use hybridization (binding) of single-stranded target DNA of unknown sequence to arrays of potentially complementary sequences of single-stranded DNA.²⁰ The concept of hybridization to DNA arrays fabricated on flat substrates such as plastic or glass is illustrated in Figure 6.4. Short strands of single-stranded DNA, so-called oligonucleotides ("oligos") are synthesized in known sequences and attached to spots in the array in a known and predetermined way. Detection of the spots that contain hybridized target DNA after the hybridization event allows one to infer the sequence of DNA in the unknown target. The utility of this technique, in combination with other DNA and RNA manipulation techniques, is discussed in greater detail in the remainder of this chapter. RNA readily



FIGURE 6.3 Photograph of hybrid microfluidic circuit that contains a commercial micropump (Mainz, Germany), a dielectrophoresis chip, load and waste wells, and fluidic interconnects, potted in silicone rubber.

²⁰ R.T. Drmanac and R.B. Crkvenjakov, Hyseq Technology. April 13, 1993. Method of sequencing genomes by hybridization of oligonucleotide probes. U.S. Patent 5,202,231.
 R.T. Drmanac and R.B. Crkvenjakov, Hyseq Technology. February 20, 1996. Method of determining an ordered sequence of subfragments of a nucleic acid fragment by hybridization of oligonucleotide particles. U.S. Patent 5,492, 806.
 R.T. Drmanac and R.B. Crkvenjakov, Hyseq Technology. June 11, 1996. Method of sequencing by oligonucleotide probes. U.S. Patent 5,525,464.
 R.T. Drmanac and R.B. Crkvenjakov, Hyseq Technology. September 16, 1997. Method of sequencing genomes by hybridization of oligonucleotide probes. U.S. Patent 5,667,972.
 R.T. Drmanac and R.B. Crkvenjakov, Hyseq Technology. December 9, 1997. Method of sequencing by hybridization of oligonucleotide probes. U.S. Patent 5,695,940.
 J. Baier, Hyseq Technology. March 16, 1999. Reagent transfer device. U.S. Patent 5,882,930.
 R.T. Drmanac and R.B. Crkvenjakov, Hyseq Technology. October 26, 1999. Computer-aided analysis system for sequencing by hybridization. U.S. Patent 5,972,619.
 R.T. Drmanac and R.B. Crkvenjakov, Hyseq Technology. January 25, 2000. Method of sequencing genomes by hybridization of oligonucleotide probes. U.S. Patent 6,018,041.
 R. Drmanac, Hyseq Technology. February 15, 2000. Methods and apparatus for DNA sequencing and DNA identification. U.S. Patent 6,025,136.
 J. Eggers, K.M. Beattie, J. Shumaker, M. Hogan, R. Varma, J. Lamture, M.A. Hollis, D. Ehrlich, and D. Rathman. 1993. Genosensor technology. *Clinical Chemistry* 39:719-722.
 S.P.A. Fodor. 1997. DNA sequencing—Massively parallel genomics. *Science* 277:393.
 E.M. Southern. 1982. Application of DNA analysis to mapping the human genome. *Cytogenet. Cell Genet.* 32:52-57.
 E.M. Southern. 1982. New methods for analyzing DNA make genetics simpler. *Biochemistry Society* 10:1-4.

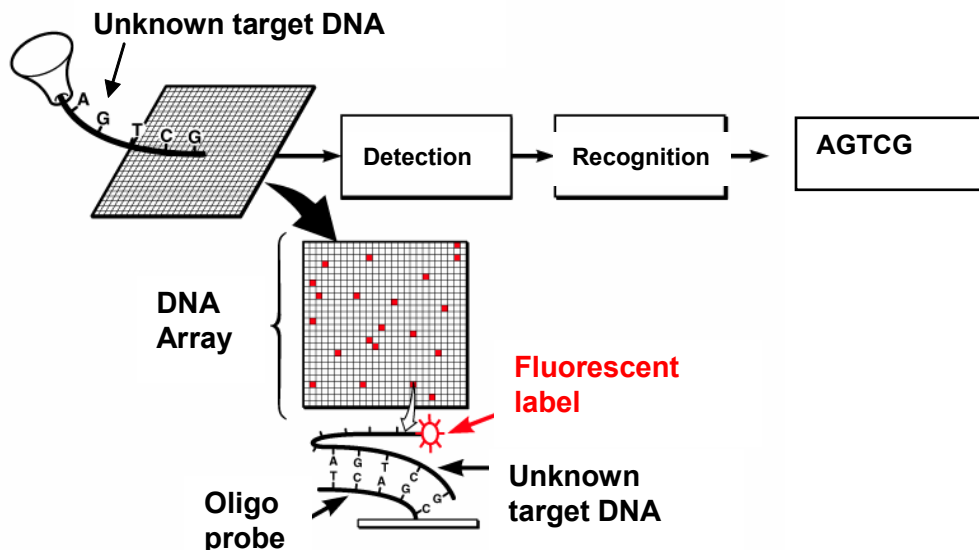

FIGURE 6.4 Concept of the detection of the sequence of unknown target DNA via hybridization to oligonucleotides in an array. This has become a popular method to detect DNA sequences, identify organisms, and study gene expression.

hybridizes to form double-stranded structures to its complementary sequence (A-T, C-G, G-C, U-A). Thus, arrays of single-stranded DNA can be used to detect RNA via hybridization.

Work has been published²¹ that describes a large acceleration of the process of hybridization of nucleic acids to surface-immobilized DNA using electrophoretic transport of the nucleic acid in solution to specific sites on the array (Figure 6.4).

Group I: Assays That Use Amplification Techniques

The majority of nucleic acid-sequence-based assays that are performed today rely on amplification of target sequences at some point in their procedures. The reason for this is that a number of amplification techniques have been demonstrated to perform, under reproducible conditions, selective amplification and copying of target sequences of DNA or RNA by factors of 10^9 or higher. This ability to generate such high numbers of the selected sequence permits the detection of the sequence of interest using relatively easy methods, even when few copies of the sequence of interest were originally present. Single-copy amplification and detection have been reported routinely, although the risk of false negative results due to Poissonian sampling errors normally compels the practitioners to avoid working at such low starting numbers.²²

All of the amplification techniques employ enzymes or engineered fragments of enzymes as critical, consumable reagents. Also, all of these techniques consume nucleotides A, C, G, and T or U as part of the chemical reactions that copy the sequence of interest. The PCR method (see below) requires both

²¹ Y. Huang, K.L. Ewalt, M. Tirado, T.R. Haigis, A. Forster, D. Ackley, M.J. Heller, J.P. O'Connell, and M. Krihak. 2001. Electric manipulation of bioparticles and macromolecules on microfabricated electrodes. *Anal. Chem.* 73(7):1549-1559.

²² Although a well-developed PCR assay is capable of detecting a single target DNA sequence, one cannot reliably detect unknowns at such low levels, even when inhibitors have been removed. This can be understood simply by Poisson's distribution, assuming a random sampling process. If the average number of target DNA sequences in a sample is 1 (the product of concentration times sample volume = 1), then the probability that you will have zero targets in the sample is given by $P(0) = 1/e = 37$ percent. (Although the average number may be 1, some samples will contain 2 or more, and some will contain none.) This has been well known amongst practitioners of PCR for a decade, according to Gary Long and Bill Nelson of Tetracore (2002). Based on Poissonian statistics, one needs an average of 10 copies of target DNA in a PCR reaction in order to detect the target with 99.99 percent certainty (again, assuming an absence of inhibitors).

short oligomers, known as primers, as well as the individual nucleotides, while the ligase chain reaction (LCR),²³ for example, requires oligomers, but does not require individual nucleotides. One could contemplate the reclamation and reuse of some reagents, such as the enzymes, salts, and nucleotides, but repeated operation of any of the amplification techniques tends to generate spurious products, even in the absence of the official target sequence.

Single-target assays have been performed using well-characterized samples (known to have no inhibitors), wherein results have been observed within 5 to 7 minutes of the time of starting the assay.²⁴ As performed in typical laboratory settings, however, the overall process of collecting a sample, preparing it, performing the assay and detection process, and analyzing the results requires at least 1 hour.

Polymerase Chain Reaction Method

The vast influence of PCR is reflected by the fact that the PubMed search engine found more than 30,000 publications in 2001 and 2002 (as of August 2002) with the word PCR in their titles. PCR is an enzyme-based chemical reaction²⁵ that manufactures copies of one or more selected regions of double-stranded DNA sequences, known as target sequences, on samples of DNA, referred to as substrates. Not surprisingly, the enzyme that is the heart of PCR is polymerase, which is found in various forms in all bacteria and higher organisms. PCR per se does not work with RNA.²⁶

Numerous commercial versions of the polymerase enzyme or its engineered fragment are available today. The one feature that all commercial polymerases used in PCR have in common is that they are thermally stable, so they are not destroyed when heated to 96°C or 97°C for a few seconds per cycle. They can perform their copying and amplification process over a range of temperatures from 50°C to above 70°C. The process of copying the DNA sequence of interest, known as extension, may proceed at a rate of roughly 100 bases per second, depending upon the conditions. In linear amplification, only one strand of a double-stranded Watson-Crick pair is copied. However, in typical PCR, both complementary sequences of a Watson-Crick pair are copied during each cycle of the PCR. Thus, after N cycles, assuming that the process has worked efficiently (high productivity), for each copy of target DNA sequence that was present when the reaction process began, the reaction will have manufactured $(2N-1)$ copies. If the productivity of the system is low, however, one may find little or no amplification after N cycles.²⁷

Cycling times of 15 to 20 seconds have been reported with high productivity for a single-target PCR assay using 25-microliter reaction volumes in a polypropylene sample tube, starting with 50 through 5,000 bacteria.²⁸ If the appropriate reagents are used so that more than one sequence and its complement are

²³ D.Y. Wu. 1989. The ligation amplification reaction (LAR)—Amplification of specific DNA sequences using sequential rounds of template-dependent ligation. *Genomics* 4:560-569.

K. Backman. 1992. Ligase chain reaction: Diagnostic technology for the 1990s and beyond. *Clinical Chemistry* 38(3) 457-458.

²⁴ Belgrader et al., 1999. See note 10 above.

²⁵ K. Mullis, F. Faloona, S. Scharf, R. Saiki, G. Horn, and H. Erlich. 1986. Specific enzymatic amplification of DNA in vitro: The polymerase chain reaction. *Cold Spring Harbor Symposia on Quantitative Biology* 51:263-273.

K.B. Mullis, H.A. Erlich, N. Arnheim, G.T. Horn, R.K. Saiki, and S.J. Scharf, Cetus Corporation. July 28, 1987. Process for amplifying, detecting, and/or cloning nucleic acid sequences. U.S. Patent 4,683,195.

R.K. Saiki, D.H. Gelfand, S. Stoffel, S.J. Scarf, R. Higuchi, G.T. Horn, K.B. Mullis, and H.A. Ehrlich. 1988. Primer-directed enzymatic amplification of DNA with thermostable DNA polymerase. *Science* 239:487-491.

²⁶ Roche Molecular Systems has developed an RNA assay, AMPLICOR, which detects HIV, an RNA virus, using the reverse transcriptase activity of one polymerase enzyme in a single-tube assay. There are also single-tube assays that use a separate reverse transcriptase enzyme to convert RNA into DNA. Once this step is performed, the reaction mixture can be heated to 96°C, at which point the PCR may begin, and the reverse transcriptase enzyme is permanently denatured.

²⁷ In this publication, even starting with 10^8 copies of target DNA in a well-characterized sample, running only a single-target assay showed a rapid decrease in detectable product when 20 cycles were performed with a total duration below 3 to 4 minutes; See, for example, M.U. Kopp, A.J. Mello, and A. Manz. 1998. Chemical amplification: Continuous flow PCR on a chip. *Science* 280:1046-1048.

²⁸ Belgrader et al., 1999. See note 10 above.

copied, the process is referred to as multiplex PCR. It is commonly found that multiplex PCR requires longer cycling times.²⁹

There are several methods of monitoring the products of PCR. One of the most accurate is the use of fluorogenic probes. Examples are Taqman³⁰ or Molecular Beacons.³¹ These reactions are sometimes referred to as real-time PCR, since it is possible to monitor the reaction yield after every cycle of the PCR.³² When compared with the original PCR procedure that required electrophoresis to determine the presence of product(s), real-time PCR has provided increased sensitivity, specificity, and rapidity of the assay.³³ When the samples are well characterized, it is possible both to detect and to quantify the number of starting copies of target DNA in the PCR.

When PCR is used without fluorogenic probes, the product is typically detected using gel or capillary electrophoresis or via hybridization against an array or microarray of probes (see discussion below on microarrays and HySeq patents and Affymax patents). The overwhelming majority of PCR that is performed around the world today is not real-time PCR.

Reliable PCR has several requirements. First, the reagents and cycling temperatures that are used to perform the assay must have been thoroughly tested and optimized. The instrument that is used must perform as required in terms of cycling times and temperatures. Finally, the sample must have been thoroughly evaluated by experts,³⁴ who then guide the necessary sample preparation³⁵ prior to the PCR.

One exciting recent development has been the use of PCR with other techniques in order to increase the power of the overall procedure. For example, *in situ* PCR is being used with flow cytometry.³⁶ Also, PCR has been integrated with electrophoresis to increase the throughput of the assays.³⁷ Similarly, the use of mass spectroscopy has enabled rapid throughput of PCR analyses.³⁸

²⁹ S. Nasarabadi, Lawrence Livermore National Laboratory. Discussions with the committee in 2002.

³⁰ R. Higuchi, C. Fockler, G. Dollinger, and R. Watson. 1993. Kinetic PCR analysis: Real-time monitoring of DNA amplification reactions. *Biotechnology* 11:1026-1030.

M.S. Ibrahim, R.S. Lofts, P.B. Jahrling, E.A. Henchal, V.W. Weedn, M.A. Northrup, and P. Belgrader. 1998. Real-time microchip PCR for detecting single-base differences in viral and human DNA. *Anal. Chem.* 70:2013-2017.

Belgrader et al., 1999. See note 10 above.

P. Belgrader, W. Bennett, D. Hadley, G. Long, R. Mariella, Jr., F. Milanovich, S. Nasarabadi, W. Nelson, J. Richards, and P. Stratton. 1998. Rapid pathogen detection using a microchip PCR array instrument. *Clinical Chemistry* 44:2191-2194.

³¹ S. Tyagi and F.R. Kramer. 1996. Molecular beacons: Probes that fluoresce upon hybridization. *Nature Biotechnology* 14:303-308.

³² One of the most powerful Taqman instruments in terms of spectroscopic analyses and depth of possible multiplexing does not provide real-time data after each cycle. One must wait until all of the preprogrammed thermal cycles have run and the analysis software has performed its functions before one may view the data. Total elapsed time has typically been 2 to 3 hours.

³³ Higuchi et al., 1993. See note 30 above.

Belgrader et al., 1999. See note 10 above.

Belgrader et al., 1998. See note 30 above.

³⁴ T. Moretti, B. Koons, and B. Budowle. 1998. Enhancement of PCR amplification yield and specificity using *ampliTaQ Gold* DNA polymerase. *Biotechniques* 25:716-722.

³⁵ P. Belgrader, D. Hansford, G. Kovacs, K. Ventkateswaran, R. Mariella, Jr., F. Milanovich, S. Nasarabadi, M. Okuzumi, F. Pourahamadi, and M. Northrup. 1999. A minisonicator to rapidly disrupt bacterial spores for DNA analysis. *Anal. Chem.* 71:4232-4236.

³⁶ B.K. Patterson, C. Goolsby, V. Hodara, K.L. Lohman, and S.M. Wolinsky. 1995. Detection of CD4+ T cells harboring human immunodeficiency virus type 1 DNA by flow cytometry using simultaneous immunophenotyping and PCR-driven *in situ* hybridization: Evidence of epitope masking of the CD4 cell surface molecule *in vivo*. *Journal of Virology* 69:4316-4322.
D.E. Gibellini, M.C. Re, G. Furlini, and M. La Placa. 1997. Flow cytometry analysis of an *in situ* PCR for the detection of human immunodeficiency virus type-1 (HIV-1) proviral DNA. *Methods in Molecular Biology* 71:113-122.
E.M. Gaynor, M.L. Mirsky, and H.A. Lewin. 1996. Use of flow cytometry and RT-PCR for detecting gene expression by single cells. *Biotechniques* 21:286-291.

³⁷ J. Cheng, E.L. Shelton, L.Wu, A. Uribe, L.O. Gerrue, J. Carrino, M.J. Heller, and J.P. O'Connell. 1998. Preparation and hybridization analysis of DNA/RNA from *E. coli* on microfabricated bioelectronic chips. *Nature Biotechnology* 16:541-546.

³⁸ N.H. Chiu, K. Tang, P. Yip, A. Braun, H. Koster, and C.R. Cantor. 2000. Mass spectrometry of single-stranded restriction fragments captured by an undigested complementary sequence. *Nucleic Acids Research* 28:e31.

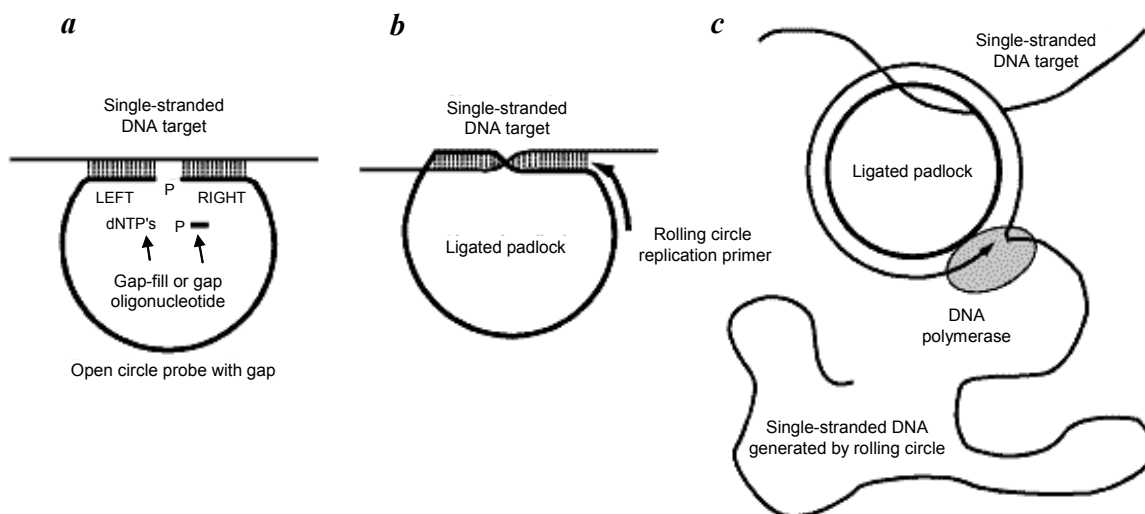

FIGURE 6.5 Rolling-circle amplification (RCA) technique: (a) a single-stranded DNA oligonucleotide probe with recognition sequences on each end binds to (recognizes) complementary target sequences in a single-stranded DNA target. A small gap-fill oligonucleotide fills the gap in the probe and completes a double-strand section to make a so-called ligated padlock, or circle of DNA hybridized to the target; (b) and (c) a DNA polymerase replication primer is added that continuously runs around the ligated padlock circle, replicating a long strand of DNA that contains many repeats of sequence complementary to that of the circle. SOURCE: P.M. Lizardi, X. Huang, Z. Zhu, P. Bray-Ward, D.C. Thomas, and D.C. Ward. 1998. Mutation detection and single-molecule counting using isothermal rolling-circle amplification. *Nature Genetics* 19:225-232.

Techniques Based on Amplification That Do Not Use PCR

There are a number of techniques that use amplification of the nucleic acid target sequence that do not employ what is strictly defined as classical PCR. For example, as shown in Figure 6.5, rolling circle amplification (RCA) uses a relatively small circular template of single-stranded DNA in a mixture of polymerase and appropriate reagents to generate long strands of complementary DNA (cDNA) that contain many repeats of the sequence in the circular template.³⁹ The small circular template can be used as a probe to bind to and thereby identify unknown target DNA. After the RCA is completed, the target DNA ends up being attached to a long strand of cDNA. RCA has been demonstrated to work with intracellular RNA as the template (in situ detection), but this requires the use of multiple enzymes and does not proceed quickly enough to be applicable in the detect-to-warn application.⁴⁰

Copy strands containing hundreds of repeats can be generated in as few as 2 minutes,⁴¹ although the reaction presently requires 1 to 2 hours of preparation and ligation time. An important advantage of RCA over PCR is that it does not require thermal cycling—the copying reaction can proceed isothermally once it begins—which simplifies the instrumentation. RCA is a linear amplification process, while PCR is an exponential amplification process. The fact that RCA produces a substantial amount of cDNA (thereby making the detection easier) in a few minutes gives it some far-term promise as a technology for fast DNA

³⁹ P.M. Lizardi, X. Huang, Z. Zhu, P. Bray-Ward, D.C. Thomas, and D.C. Ward. 1998. Mutation detection and single-molecule counting using isothermal rolling-circle amplification. *Nature Genetics* 19:225-232.

B. Schweitzer, S. Wiltshire, J. Lambert, S. O'Malley, K. Kukanskis, Z. Zhu, S.F. Kingsmore, P. M. Lizardi, and D.C. Ward. 2000. Immunoassays with rolling circle DNA amplification: A versatile platform for ultrasensitive antigen detection. *Proc. Natl. Acad. Sci.* 97:10113-10119.

⁴⁰ A.T. Christian, M.S. Pattee, C.M. Attix, B.E. Reed, K.J. Sorensen, and J.D. Tucker. 2001. Single-base and mRNA detection by rolling circle amplification in individual cells. *Proc. Natl. Acad. Sci.* 98:14238-14243.

⁴¹ Lizardi et al., 1998. See note 39 above.

detection, provided there is substantial additional development. If one started with a relatively high number of copies of the sequence of interest, RCA might produce a detectable amount of product before PCR did.

Strand-displacement amplification (SDA) uses a recognition sequence such as 5'-GTTGAC-3' that is hybridized to the end of the target DNA via a primer. This recognition sequence is nicked in each cycle and a fragment of an appropriate polymerase binds to this site, replicates the complementary 3'-5' target strand, and the enzyme displaces the original 5'-3' strand, freeing it to diffuse away in solution (see Figure 6.6).⁴² After an initial heating step to denature the original target DNA, this process proceeds isothermally without heating cycles and can produce 10^{12} copies of a single target DNA sequence in 30 minutes at 37°C.⁴³ An in situ hybridization version of the technique has been used to detect as few as one gene copy of human immunodeficiency virus (HIV) DNA in individual cells.⁴⁴ Though reasonably fast in its amplification and very sensitive, this technique so far requires more than 2 hours of sample and reagent preparation time.

As shown in Figures 6.7 and 6.8, a hybrid of RCA and SDA can be achieved by first replicating cDNA from a circular template and then using SDA on the resulting cDNA strands to create dendritic trees of cDNA (so-called branched DNA or bDNA), all bound to a central core.⁴⁵ Such techniques may merit further monitoring and consideration, simply because of their ability to produce copious quantities of cDNA in a few minutes.

Another technique that can amplify DNA or RNA is nucleic acid-sequence-based amplification (NASBA).⁴⁶ The process uses a collection of enzymes (T7 RNA polymerase, Ribonuclease (RNase) H,

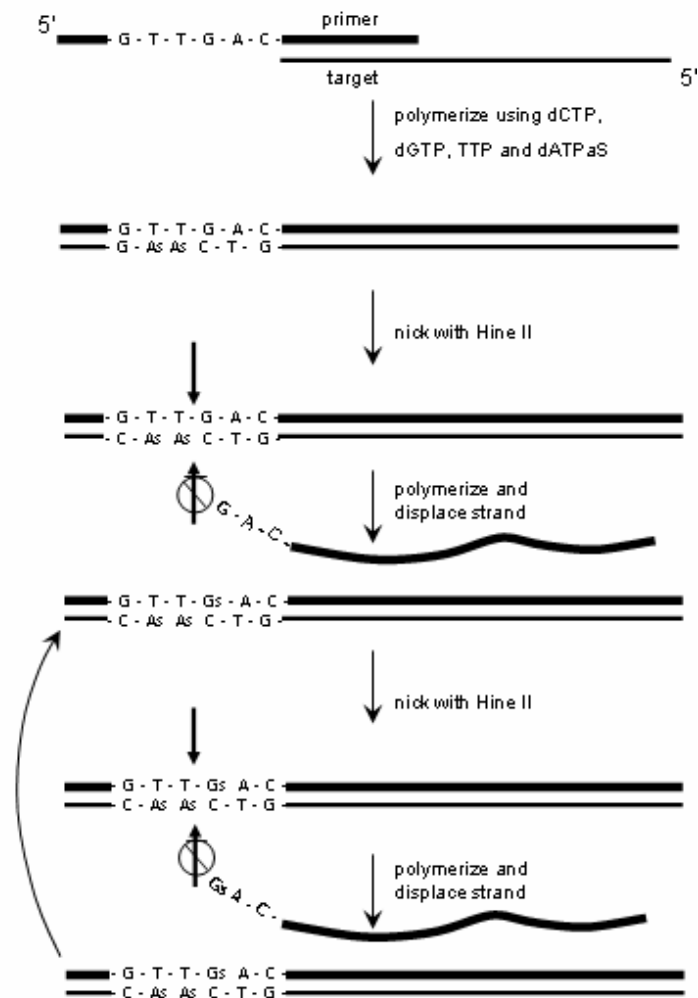

FIGURE 6.6 Strand-displacement amplification (SDA).

⁴² T.G. Walker. 1992. Isothermal in vitro amplification of DNA by a restriction enzyme/DNA polymerase system. *Proc. Natl. Acad. Sci.* 89:392-396.

T.G. Walker. 1992. Strand displacement amplification—An isothermal, in vitro DNA amplification technique. *Nucleic Acids Research* 20(7):1691-1696.

⁴³ G. Nuovo. 2000. In-situ strand displacement amplification: An improved technique for the detection of low copy nucleic acids. *Diagnostic Molecular Pathology* 9(4):195-202.

⁴⁴ Walker, 1992. See note 42 above.

⁴⁵ Lizardi et al., 1998. See note 39 above.

F.B. Dean, J.R. Nelson, T.L. Giesler, and R.S. Laskin. 2001. Rapid amplification of plasmid and phage DNA using Phi29 DNA polymerase and multiply-primed rolling circle amplification. *Genome Res.* 11:1095-1099.

⁴⁶ J. Compton. 1991. Nucleic acid sequence-based amplification. *Nature* 350:91-92.

L. Malek, S. Darash, C. Davey, G. Henderson, M. Howes, P. Lens, and R. Sooknanan. 1992. Application of NASBA isothermal nucleic-acid amplification method to the diagnosis of HIV-1. *Clinical Chemistry* 38:458.

alfalfa mosaic virus (AMV) reverse transcriptase, and other reagents) to copy RNA or DNA isothermally at room temperature. Amplification factors of 10^8 can be obtained in 60 minutes. Because it can replicate messenger RNA (mRNA), which is present typically in viable organisms only, nucleic acid sequence-based amplification (NASBA) has been used not only for detection and identification but also for the detection, identification, and discrimination of viable organisms via the detection of mRNA expressed due to a heat-shock step.⁴⁷ The fact that this technique is isothermal, can replicate RNA as well as DNA, and can be used as a viability test might allow it to be used as a second confirmation step following a detect-to-warn stage.

Another non-PCR amplification method considered is the ligase amplification reaction (LAR), also known as the ligase chain reaction (LCR).⁴⁸ This method, mentioned briefly above, is similar to PCR in its need for thermal cycling but uses two oligonucleotide probes that bind to adjacent sites on the target DNA at the lower temperature of the thermal cycle. The two oligonucleotides then ligate and are driven off (denatured) as the temperature cycles to the peak. This process is repeated to create many copies of the ligated oligo

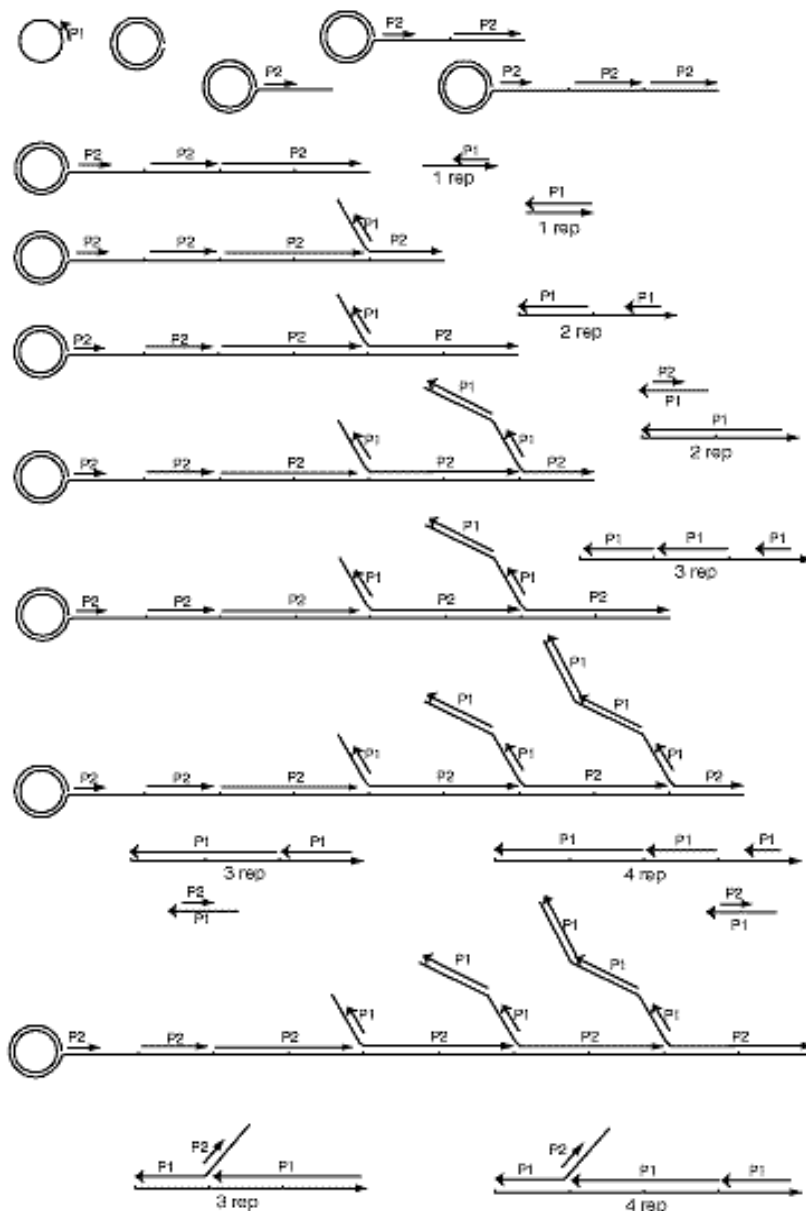

FIGURE 6.7 A combination of RCA and SDA.

- H. Revets, D. Marissens, S. de Wit, P. Lacor, N. Clumeck, S. Lauwers, and G. Zissis. 1996. Comparative evaluation of NASBA HIV-1 RNA QT, AMPLICOR-HIV monitor, and QUANTIPLEX HIV RNA assay, three methods for quantification of human immunodeficiency virus type 1 RNA in plasma. *J. Clin. Microbiol.* 34:1058-1064.
- ⁴⁷ A.J. Baeumner, M.C. Humiston, R.A. Montagna, and R.A. Durst. 2001. Detection of viable oocysts of cryptosporidium parvum following nucleic acid sequence based amplification. *Anal. Chem.* 73(6):1176-1180.
- M.B. Esch, A.J. Baeumner, and R.A. Durst. 2001. Detection of cryptosporidium parvum using oligonucleotide-tagged liposomes in a competitive assay format. *Anal. Chem.* 73(13):3162-3167.
- A.J. Baeumner, N.A. Schlesinger, N.S. Slutzki, J. Romano, E.M. Lee, and R.A. Montagna. 2002. Biosensor for dengue virus detection: Sensitive, rapid, and serotype specific. *Anal. Chem.* 74(6):1442-1448.
- ⁴⁸ D.Y. Wu and R.B. Wallace. 1989. The ligation amplification reaction (LAR)—Amplification of specific DNA sequences using sequential rounds of template-dependent ligation. *Genomics* 4(4):560-569.
- K. Backman. 1992. Ligase chain reaction: Diagnostic technology for the 1990s and beyond. *Clinical Chemistry* 38(3):457-458.



FIGURE 6.8 Another combination of RCA and SDA.

molecules and is claimed to have the ability for single-base-mutation discrimination (i.e., the oligos do not ligate if there is a mutation at the juncture site). Since this method requires thermal cycling and the accurate hybridization and ligation of relatively long oligomers of DNA for each cycle, the committee does not believe it is a contender for use in a 1-minute detection system.

Finally, rapid doubling times for RNA have been reported with the use of Q β replicase. For example, the MDV fragment has been copied using Q β replicase in 12 seconds. The conditions for which this was achieved were limited, and the majority of RNA fragments that were studied in this research did not display such rapid doubling times.⁴⁹ Until this technique is shown to work with RNA from lysed cells and in a multiplex format, the committee cannot include it as a likely component of a 1-minute detection system.

Finally, rapid doubling times for RNA have been reported with the use of Q β replicase. For

The idea of producing an integrated system that does rapid identification using PCR or other target-amplification assay in under 5 minutes is already being pursued at the research stage around the world. Although this research is still ongoing, the committee judges that the probability of a first prototype demonstration being realized within 2 years is reasonably high.

Detection of Amplified Target Sequences Using Array Technologies

Since the late 1980s, DNA microarray (so-called "DNA chip") technology has been developed to provide a method for the parallel analysis of target DNA strands.⁵⁰ The technique builds upon the work of Southern⁵¹ and typically deposits an array of synthesized oligos in spots on a two-dimensional surface of silica or various polymers (Figure 6.4). The coding sequence of oligos in each site is the same and is known, and it differs from site to site in a known and designed way.

Target DNA strands that are washed onto the array and allowed to settle will hybridize to oligos having an exactly complementary sequence but will only weakly bind to oligos that do not have an exact match if the chemistry of the solution is properly adjusted. The hybridized target DNA is usually labeled in some manner such as with a fluorescent dye molecule so that the pattern of hybridization across the array can be detected. The sequence of the original target DNA can then be inferred using a computer algorithm, provided that the coding sequence of the oligos in the array was properly designed and that the target DNA strands are not too long and do not have large repeats of sequence. Much work has been put into the development of this technology over the past 10 years, and it is now used ubiquitously in gene-expression studies, drug development, bioagent analysis and detection, and many other fields. The concept of using such an array of oligos to determine the sequence of a sample is known as sequencing by hybridization.⁵²

⁴⁹ J.L. Burg, A.M. Juffras, Y.Wu, L. Blomquist, and Y. Du. 1996. Single molecule detection of RNA reporter probes by amplification with Q β replicase. *Mol. and Cellular Probes* 10:357-271.

J.S. Shah, J. Liu, J. Smith, S. Popoff, G. Radcliffe, W. J. O'Brien, G. Serpe, D.M. Olive, and W. King. 1994. Novel, ultrasensitive, Q-beta replicase amplified hybridization assay for detection of Chlamydia trachomatis. *J. Clin. Microbiol.* 32:2718-2724.

S. Paillason, S.M. Van De Corput, R.W. Dirks, H.J. Tanke, M. Robert-Nicoud, and X. Ronot. 1997. In-situ hybridization in living cells: Detection of RNA molecules. *Experimental Cell Research* 231:226-233.

⁵⁰ Eggers et al., 1993. See note 20 above.

J.B. Lamature, K.L. Beattie, B.E. Burke, M.D. Eggers, D.J. Ehrlich, R. Fowler, M.A. Hollis, B.B. Kosicki, R.K. Reich, S.R. Smith, R.S. Varma, and M.E. Hogan. 1994. Direct detection of nucleic acid hybridization on the surface of a charge coupled device. *Nucleic Acids Research* 22(11):2121-2125.

S.P.A. Fodor. 1997. DNA sequencing—Massively parallel genomics. *Science* 277(5324):393.

⁵¹ Southern, 1982. See note 20 above.

⁵² M.C. Pirrung, J.L. Read, S.P.A. Fodor, and L. Stryer, Affymax Technologies. September 1, 1992. Large scale photolithographic solid phase synthesis of polypeptides and receptor binding screening thereof. U.S. Patent No. 5,143,854.

One of the drawbacks of conventional DNA microarray technology for the detect-to-warn application is that the conventional hybridization step and subsequent rinses typically can take several hours. Another drawback is that nonspecific binding of target DNA to oligos can occur, and one typically needs well-controlled experiments and good imaging and computer algorithms to correct for this. One of the most important drawbacks is that the technology typically uses PCR to amplify the amount of target DNA before applying it to the array to maximize the signal. These factors all combine to make the conventional DNA microarray technology unsuitable for detect-to-warn applications.

To address these drawbacks, workers have improved the speed of hybridization to times of less than 5 minutes by using electrophoretic transport to draw the target DNA to the oligo sites quickly, as discussed with Figure 6.4.⁵³ This particular approach has still required the use of PCR-amplified and -labeled target DNA, and the amplification steps take time. Others have developed alternative labeling systems that use electrically or optically sensed labels to try to improve the speed and sensitivity of detection,⁵⁴ but these methods do not meet the time requirements for detect-to-warn and still require PCR-amplified DNA for trace-level detection. To try to eliminate the effort and time required for the labeling of target DNA, workers have also developed a hybridization-detection method using permittivity sensing of changes in the electrochemical boundary layer on electrodes in the test sites to which the oligos are attached.⁵⁵ The relative signal change sensed by this method using even PCR-amplified target DNA was relatively small (less than 20 percent), and it does not seem to be a sufficiently robust candidate to improve microarray performance. Surface-plasmon resonance has also been reported in the literature as a technique that can detect hybridization without the use of labels.⁵⁶ Direct, unlabeled detection of 16S rRNA on DNA microarrays has also been reported on a notional detector, as described in Box 6.2.

Techniques based on mass spectrometry have also been developed to detect nucleic acid sequences.⁵⁷ While these work quite well in the laboratory, they do require about 10^8 molecules for detection and thus PCR amplification, which slows them down, as well as vacuum pumps and sophisticated instrumentation. In addition, they require significant sample preparation and cleanup for contaminated samples and have difficulty deconvolving the signals from mixtures of DNA from different organisms that may be present in environmental samples if the selectivity of the PCR amplification is insufficient. It is difficult to see how these mass-spectrometry techniques could be implemented conveniently and inexpensively in field- or building-monitoring situations for detect-to-warn requirements.

W.J. Dower, S.E. Cwirla, and R.W. Barrett, Affymax Technologies. July 11, 1995. Peptide library and screening systems. U.S. Patent No. 5,432,018.

M.C. Pirrung, J.L. Read, S.P.A. Fodor, and L. Stryer, Affymax Technologies. April 11, 1995. Large scale photolithographic solid phase synthesis of an array of polymers. U.S. Patent No. 5,405,783.

D. Campbell, Affymax Technologies. November 8, 1994. Chiral synthesis of alpha-aminophosphonic acids. U.S. Patent 5,362,899.

⁵³ Y. Huang, K.L. Ewalt, M. Tirado, T.R. Haigis, A. Forster, D. Ackley, M.J. Heller, J.P. O'Connell, and M. Krihak. 2001. Electric manipulation of bioparticles and macromolecules on microfabricated electrodes. *Anal. Chem.* 73:1549-1559.

J. Cheng, E.L. Shelton, L. Wu, A. Uribe, L.O. Gerrue, J. Carrino, M.J. Heller, and J.P. O'Connell. 1998. Preparation and hybridization analysis of DNA/RNA from E-Coli on microfabricated bioelectronic chips. *Nature Biotechnology* 16:541-546.

J. Yang, Y. Huang, X.B. Wang, F.F. Becker, and P.R. Gascoyne. 1999. The removal of human breast cancer cells from hematopoietic CD34+ stem cells by dielectrophoretic field-flow-fractionation. *J. Hemat. Stem Cell Res.* 8:481-490.

⁵⁴ C.J. Yu, Y.J. Wan, H. Yowanto, J. Li, C.L. Tao, M.D. James, C.L. Tan, G.F. Blackburn, and T.J. Meade. 2001. Electron detection of single-base mismatches in DNA with ferrocene-modified probes. *Journal of the American Chemical Society* 123:11155-11161.

T.A. Taton, C.A. Mirkin, and R.L. Letsinger. 2000. Scanometric DNA array detection with nanoparticle probes. *Science* 289:1757-1760.

S.J. Park, T.A. Taton, and C.A. Mirkin. 2002. Array-based electrical detection of DNA with nanoparticle probes. *Science* 295:1503-1506.

Y.C. Cao, R. Jin, and C.A. Mirkin. 2002. Nanoparticles with Raman spectroscopic fingerprints for DNA and RNA detection. *Science* 297:1536-1540.

⁵⁵ M. Hollis, MIT Lincoln Laboratory, 1998. Unpublished data communicated to the committee in 2002.

D. Hodko, Lynntech, Inc. Unpublished data, 2002.

⁵⁶ K.E. Nelson, I.T. Paulsen, J. F. Heidelberg, and C.M. Fraser. 2000. Status of genome projects for nonpathogenic bacteria and archaea. *Nature Biotechnology* 18:1049-1054.

⁵⁷ Ibis Therapeutics and SAIC, San Diego, Calif. C. Cantor, Sequenom. Presentation to the committee on June 12, 2002.

Box 6.2**Notional Detection and Identification System Based on Ribosomal RNA**

Below, the committee describes an identification system that does not exist but that might, conceivably, be created to function within the 1-minute time limit that is desired for the detect-to-warn (DTW) application. An estimate is made of the performance requirement of a conceptual DTW system against a hypothetical aerosol challenge. The committee first estimates the physiologically relevant concentration of this agent in air, looking at the required sensitivity that this DTW system must have to detect the minimum concentration of agent that would present a hazard if it is breathed for 5 minutes. It is assumed that the individuals involved would take protective action within a few minutes of being warned. The lower limit of sensitivity is examined, because a system with poor performance in terms of sensitivity would be relatively prone to false negatives, even for hazardous levels of agent.

The committee starts by estimating the physiologically relevant concentration of an aerosolized pathogenic agent inside of a building, for a person not particularly exerting herself or himself. The exchange of air within the alveoli (the innermost surface of the lungs) is approximately 15 liters per minute. It is also assumed that the agent is present in its spore form, with a physiologically hazardous (LD_{50}) dose of roughly 8,000 spores. For a worst case analysis, it is assumed that 100 percent of the spores are viable and 100 percent of the spores that are breathed into the alveoli are captured and can begin their infective actions. Based on these assumptions, the aerosol concentration of these spores that would present an LD_{50} dose within 5 minutes of breathing would be 100 spores per liter of air.^a If the capture efficiency in the lungs is lower or if the percent of viable spores is lower, then the corresponding aerosol concentration that would present a hazard within a time frame of 5 minutes would be higher.

The assay proceeds through the following steps, with a time budget of 60 seconds: sample collection, sample preparation, performance of an assay, and analysis and reporting.

- Use 10 seconds to collect a sample from the air into an aqueous solution, using a collector with a two-stage, precollection fractionator possessing an overall capture efficiency of 50 percent and a collection rate of 90 liters of air per minute into 50 microliters of aqueous volume; 100 spores per liter of air would produce 750 spores in the 50 microliters of solution.^b
- Use 5 seconds to extract 10 microliters of the solution for analysis, archiving the remaining 40 microliters and/or providing it for parallel assays.^c
- Ultrasonicate for 10 seconds to get access to the nucleic acids inside the spores. Due to the short time, assume access is gained to only 33 percent of the ribosomal RNA. Assume that each spore has roughly 10,000 copies of its rRNA. This would provide roughly 500,000 copies of the rRNA for assaying.^d
- For 5 seconds, use a pressure-driven or electrophoretic or other voltage-driven transport mechanism to move the RNA onto a sample preparation surface. It is estimated that only about 20 percent of the RNA will be captured onto the preparation surface, 100,000 copies.^e
- For 10 seconds, wash the captured RNA and then release it.^f
- For 5 seconds, use an electrophoretic or other voltage-driven transport mechanism to move the RNA onto a hybridization array for analysis via sequencing by hybridization. Assume that in its purified/concentrated form, 50 percent of the RNA reaches the array surface, 50,000 copies.^g
- Hybridize for 10 seconds, under the influence of voltage-assisted hybridization to an array of single-stranded DNA with sequences complementary to identifying ribosomal RNA sequences of threat agents. Perhaps 20 percent of RNA will hybridize, producing 10,000 correctly hybridized RNA/DNA paired strands for the identification of the organism(s).^h
- For 3 seconds, use a negative surface voltage to drive off unhybridized nucleic acids, possibly combined with a pressure-driven stringency wash.ⁱ
- In 2 seconds, detect the presence of 10,000 hybridized RNA strands using surface plasmon

resonance, or use fluorescence-resonant energy transfer probes such as Molecular Beacons^j as the immobilized probes or another label-free technique.^k

^a The typical background concentration of nonpathogenic bacteria in the air we breathe ranges from nearly zero bacteria per liter (outdoors, during a snowstorm, for example) to 100 or more bacteria per liter indoors with many people or animals present.

^b The well-known DoD bioaerosol collector, the XM-2, collects 1,000 liters of air per minute into 1 mL, using a single-stage precollection fractionator. Therefore, the committee believes that it is possible to create an aerosol collector that performs at least roughly as desired.

^c Depending upon the size of the fluidics and the distances, moving 10 microliters in 5 seconds should be possible.

^d There are no hard data on rapid release of rRNA from spores using ultrasonication. This step may easily fail.

^e Pressure-driven or electrophoretic velocities of 1 mm/s for nucleic acids are achievable in such a system, ignoring the problems of electrolysis at electrodes, which might disrupt the operation of the fluidics. If the transport distances are only 1 or 2 mm, this step may be possible. Moreover, if the capture surface is optimally designed, a much larger fraction of the RNA could be captured and released for the assay. Clogging or degradation of the capture surface may be a deleterious result of reuse.

^f The committee is not aware of rate studies for silica or other surface-based cleanup procedures in a microfluidic system. Ten seconds may not be sufficient time for this process.

^g Again, using voltage to drive the RNA off the cleanup surface and onto an array of target oligonucleotides may be possible in 5 seconds, depending upon channel dimensions, for example.

^h Accurate hybridization within 10 seconds, even with a miniature format and optimized temperature and voltage control, may not be attainable.

ⁱ A "stringency" washing of unhybridized (or mishybridized) nucleic acids would only have to move them a fraction of a millimeter away from the surface to remove their interfering effects on the readout process, since they will be unlabeled. Two or three seconds may suffice if voltage- and pressure-driven flows are combined.

^j C. Xi, M. Balberg, S.A. Boppart, and L. Raskin. 2003. Use of DNA and peptide nucleic acid molecular beacons for detection and quantification of rRNA in solution and in whole cells. *Appl. Environ. Microbiol.* 69(9):5673–5678.

^k Readout and analysis in 2 seconds may be possible using high-speed instrumentation. Surface-plasmon resonance has shown response times of a few seconds, under limited conditions. The committee is unaware of the demonstration of a few-second hybridization assay using Molecular Beacons. Also, although the committee has seen data on label-free hybridization of nucleic acids using a swelling of a holographic-grating film (Christopher Lowe, University of Cambridge, presentation to the committee on September 26, 2002), it has not seen time response data for this process.

Group II: Sequence-Based Assays That Do Not Use Amplification Techniques

Although there have been musings about directly reading the sequence of DNA by using a mass spectrometer or a scanning-probe microscope or a nanometer orifice, the techniques that are used today to determine the sequence of RNA or DNA are based upon hybridization.⁵⁸ These techniques include sequencing by hybridization, such as array-based techniques.⁵⁹ Multiple signal-transduction mechanisms are also possible, including signal amplification, which the committee views as different from sequence amplification. One example of a signal amplification technique is the use of a label that chemiluminesces or that can undergo repeated electrochemical oxidation-reduction reactions. Thus, if a single hybridization event occurs with DNA that is carrying this label, the label can emit many photons via chemiluminescence—horseradish peroxidase/substrate reactions, used in enzyme-linked immunosorbent assay (ELISA) or the Origen biodetector—or can participate in cyclic voltammetry using ruthenium complexes,⁶⁰ ferrocene complexes,⁶¹ or osmium tetroxide-2,2'-bipyridine.⁶²

⁵⁸ The nucleic acid sequencing work in the Human Genome Project relies primarily on capillary electrophoresis. However, all that is necessary for identification of the agents considered here is the detection of small fragments of virulent genes or plasmids. This is commonly done via hybridization.

⁵⁹ W.J. Wilson, C.L. Strout, T.Z. DeSantis, J.L. Stilwell, A.V. Carrano, and G.L. Andersen. 2002. Sequence-specific identification of 18 pathogenic microorganisms using microarray technology. *Mol. Cell Probes* 16:119-127.

⁶⁰ J. Miller, N. Frank, and T.J. Mead. 2001. Investigations of 5'-labeled ruthenium nucleotides as electron acceptor complexes. *Abstr. Papers Am. Chem. Soc.* 221:150.

⁶¹ Yu et al., 2001. See note 54 above.

⁶² E. Paleček, M. Fojta, and F. Jelen. 2002. New approaches in the development of DNA sensors: Hybridization and electrochemical detection of DNA and RNA at two different surfaces. *Bioelectrochemistry* 56:85-90.

An alternative to the sample preparation strategy described in the previous section (that of lysing the cells or spores and freeing the DNA from them) is to try to insert or diffuse the appropriate amplification/detection reagents into cells that are still intact or have had their outer membranes permeabilized. This method may avoid some of the time required for sample preparation. This so-called *in situ* detection (also known as *in situ* hybridization if it uses labeled single-stranded DNA probes) has been tried successfully with modifications of the RCA technique described above.⁶³ A similar method has also been demonstrated using a technique known as catalyzed signal amplification (CSA). This technique employs biotinylated DNA probes and a colorimetric detection process based on peroxidase-conjugated streptavidin, which is activated by application of the chromogenic substrate diaminobenzidine.⁶⁴ In this latter method the DNA is not amplified; instead, many copies of a marker dye are generated via the peroxidase/diaminobenzidine reaction. Very sensitive single-gene-copy detection within a cell has been demonstrated, though the cell preparation time is far too long (assay time of more than 2 hours in these cases) for the detect-to-warn application,⁶⁵ showing that single molecules can be probed and imaged inside single cells, though much work remains to develop this technique further.

In a more positive vein, molecular beacons (Figure 6.9) are molecules that exhibit relatively little fluorescence when unbound to target DNA but fluoresce when bound to their complementary sequence.⁶⁶ Molecular beacons could be attractive for the detect-to-warn application if means could be found to bring them together with the DNA or RNA in cells quickly, perhaps using electric-field effects or other methods

to overcome the time lag due to diffusion as described above. Trace-level detection could be enhanced for the molecular beacons via development of quenchable Stokes-shift dyes (similar to Cy3 or Cy5) to minimize signal background and/or via development of more strongly emitting dyes.

In an idea similar to molecular beacons and depicted schematically in Figure 6.10, Nie and coworkers have demonstrated the use of gold and silver nanoparticles as both attachment substrates and quenchers for fluorescently labeled oligonucleotides.⁶⁷ They report enhanced discrimination of single-base mismatches between oligo probes and the target DNA, although the hybridization kinetics are slow for both the nanoparticle-based probes and molecular beacons (50 percent hybridization is achieved in about 10 minutes). The slow hybridization is explained by a strong stability of the fluor-oligo-nanoparticle (or quencher) complex, limiting the tendency of the oligo to unfold and bind with the target. These are attractive areas and might merit further consideration, but they will need much additional work to improve the speed of the assay.

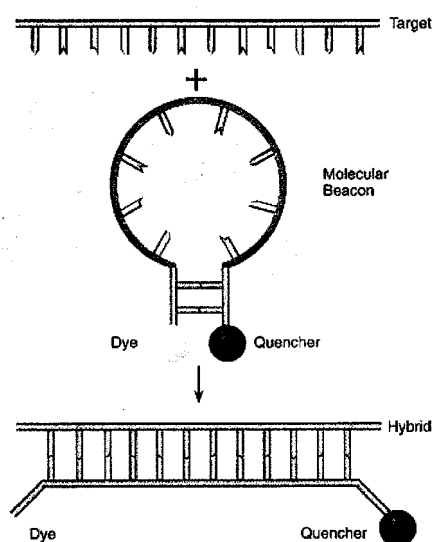

FIGURE 6.9 Concept of a molecular beacon.

⁶³ A.T. Christian, M.S. Pattee, C.M. Attix, B.E. Reed, K.J. Sorensen, and J.D. Tucker. 2001. Detection of DNA point mutations and mRNA expression levels by rolling circle amplification in individual cells. *Proc. Natl. Acad. Sci.* 98:14238-14243.

⁶⁴ G. Lizard, M.J. Demares-Poulet, P. Roinot, and P. Gambert. 2001. *In situ* hybridization detection of single-copy human papillomavirus on isolated cells, using a catalyzed signal amplification system: GenPoint. *Diagnostic Cytopathology* 24:112-116.

⁶⁵ T.A. Byassee, W.C.W. Chan, and S. Nie. 2000. Probing single molecules in single living cells. *Anal. Chem.* 72(22):5606-5611.

⁶⁶ S. Tyagi and F.R. Kramer. 1996. Molecular beacons: Probes that fluoresce upon hybridization. *Nature Biotechnology* 14:303-308.

⁶⁷ W.C.W. Chan, D.J. Maxwell, X. Gao, R.E. Bailey, M. Han, and S.N. Maxwell. 2002. Luminescent quantum dots for multiplexed biological detection and imaging. *Current Opinion in Biotechnology* 13:40-46.

D.J. Maxwell. 2002. Self-assembled nanoparticle probes for recognition and detection of biomolecules. *J. Am. Chem. Soc.* 124:9606-9612.

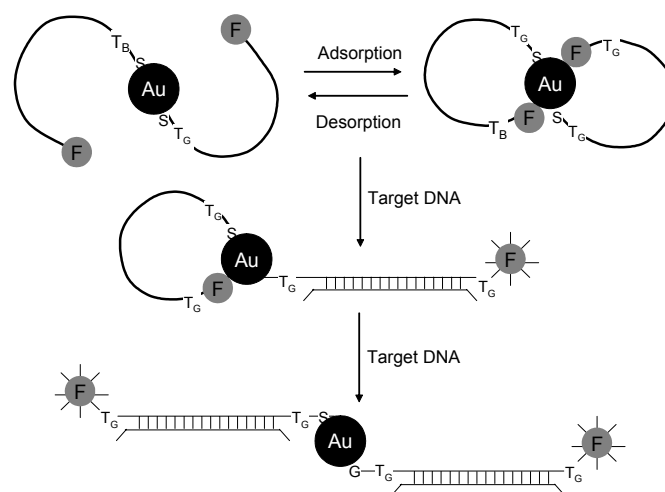

FIGURE 6.10 Nanoparticles used for DNA labeling and detection. In this method, oligos are tethered on one end to Au or Ag nanoparticles (dark circles) and are conjugated to fluorophores on their other end (grey circles). The fluorophores have some tendency to adhere to the nanoparticles under quiescent conditions, and their fluorescence is quenched in this mode. When a short single strand of target DNA hybridizes to the oligo, however, a rigid double-stranded section of DNA is formed that pulls the fluorophore from the surface of the nanoparticle, allowing it to emit light again.

Nie and coworkers have also shown that 20-nanometer fluorescent nanoparticles can be conjugated to DNA-binding proteins such as the restriction enzyme EcoRI, bound to specific sites on target DNA strands, and imaged once bound.⁶⁸ This is interesting work, but so far the experimental preparation times far exceed that required for detect-to-warn.

Another approach to signal amplification would be to use a probe with a complementary sequence for rolling circle amplification. If such a probe hybridized to a surface-immobilized sequence but maintained its RCA target sequence as unhybridized, one could, after washing the array, add a circular template that was complementary to the unhybridized portion and run RCA to generate long strands of linear sequence, complementary to the circular probe. If the circular probe possesses a sequence that is complementary to a Molecular Beacon probe, then these could attach at every corresponding complementary sequence on the growing linear strand, producing hundreds of fluorescent labels for each original hybridization event.

Detection of the hybridization of DNA is the heart of both the Taqman and Molecular Beacon probes. There has been a report of the use of surface-bound Molecular Beacon probes that detect the hybridization of unlabeled DNA. The surface-bound probes exhibit reduced levels of fluorescence until the hybridization event makes them fluorescent.⁶⁹ This has potential for the direct detection of ribosomal RNA (see Box 6.2 on a notional detector).

DETECTION, IDENTIFICATION, ANALYSIS, AND REPORTING

The specific labeling and detection methods appropriate to each technique were discussed as each technique was presented. The assay signal that is detected is either an electronic signal or a photonic

⁶⁸ Taylor et al., 2001. See note 10 above.

⁶⁹ H. Wang, J. Li, H. Liu, Q. Liu, Q. Mei, Y. Wang, J. Zhu, N. He, and Z. Lu. 2002. Label-free hybridization detection of a single nucleotide mismatch by immobilization of molecular beacons on an agarose film. *Molecular and Cellular Probes* 16:119-127.

one that is then converted into an electrical signal. Compared with the difficulty of the assays themselves, the analysis and reporting of any of these signals are relatively straightforward with present instrumentation and computers and, in the committee's view, do not pose a significant technical challenge for detect-to-warn applications, even in a miniaturized format.

Nucleic acid sequence detection technology provides a powerful set of tools to advance science and medicine. However, the concept of detect-to-warn operation in a biosensor is an extremely challenging goal for this type of technology, primarily due to the demand for speed. The committee cannot say with any confidence that a nucleic acid sequence-based technology will be able to play a role in a 1-minute detection/identification system. However, if existing technologies can be pushed beyond what has yet been done, and if they can be integrated into a system, then one can at least imagine a system that could include a nucleic acid-based detection/identification assay. For example, a sequence-based technology that could provide confirmation of an attack and identify the organisms involved could play a vital role in resolving alarms from faster, nonspecific detectors, even if the sequence-based technology had a response time on the order of several minutes. Box 6.1 describes a hypothetical 3-minute detection/identification system based on PCR.

The committee notes several promising developments that could help to reduce the response times of sequence-based detector/identifier systems. The basic process that leads to spore disruption and cell lysis during ultrasonication with beads is becoming better understood—beads may not be necessary at all; nano- or microbubbles may be all that are needed—and it may be possible to design a sample-processing front end to extract ribosomal RNA rapidly. Also, the implementation of the chemistry of Willem Boom in a microfluidic format may be customized to extract, purify, concentrate, and release RNA in a microfluidic system in seconds. Using electrophoresis, rapid transport of nucleic acids for stringent hybridization can be achieved. Significant progress has also been made using DNA arrays⁷⁰ to detect and identify organisms using ribosomal RNA. Finally, several label-free technologies could conceivably provide a readout of hybridization in seconds: surface-plasmon resonance, immobilized fluorescence-resonant-energy-transfer probes, and holographic films. It may be that research into one or more of these technologies will ultimately break the challenging kinetic barrier that currently prevents detection/identification systems based on these technologies from achieving anything close to a 1-minute overall performance. Of course, a label-free method would only be effective if it had a high detection sensitivity; otherwise, although the readout time might be reduced, the overall analysis time might be increased, since a larger volume of sample would need to be collected to provide sufficient target organisms for detection.

If the nucleic acid-based assay is to run unattended, the stability of reagents becomes a major issue. Many reagents for nucleic acid-based chemistries need to be refrigerated until use and lose their activity within hours. Reagents with poor stability would lead to signals that change over time even when detecting the same levels of targeted organisms. Highly stable reagents would not only increase the time a detector could operate unattended, but would also improve the overall reproducibility/reliability of the system.

STRAWMAN CONCEPT FOR A FAST RNA DETECTION/IDENTIFICATION SYSTEM

If any detection/identification system based on a nucleic acid sequence assay can come close to meeting a 1-minute detect-to-warn requirement, it may be one based on the sequence determination of unamplified ribosomal RNA. One such notional detection and identification system is described in Box 6.2. The basic technique has been used for the identification and categorization of bacteria,⁷¹ but the proposed methods for accelerating the assay in Box 6.2 are hypothetical and as yet untried.

⁷⁰ J. Jackman, W. Bethea, D. Chandler, and K. Chumakov. 2002. Evaluation and database development of magichip microarrays. Poster at the 23rd Army Science Conference, December 2-5, 2002, Orlando, Fla.

⁷¹ G.E. Fox. 1980. The phylogeny of prokaryotes. *Science* 209:457-463.

The ribosomes are organelles, found in all bacteria (prokaryotes) as well as in organisms with nuclei (eukaryotes). Typically, there are about 10,000 ribosomes per bacterium.⁷² The RNA that occurs in the ribosomes (rRNA) is single-stranded and has three characteristic subunits consisting of roughly 120 nucleotides, 1,540 nucleotides, and 3,000 nucleotides, respectively. By contrast, the genomic DNA in a bacterium typically has about 4 million base pairs. Due to the much greater length of the bacterial genomic DNA, the DNA affords better identification of both species and strain of a bacterium than does the rRNA, and an rRNA assay alone may be more appropriate as a rapid screening tool than as a tool for the precise identification of the bioagent.⁷³ However, the committee suggests a notional detector that uses a hybridization assay with a sequence of rRNA as its identifier because the presence of 10,000 copies of the rRNA in each bacterium may enable detection without resorting to the more time-consuming step of amplification of the nucleic acid.

FINDINGS AND RECOMMENDATIONS

Detection and identification of organisms by assays based on nucleic acid sequencing are accepted worldwide as offering the greatest information content and sensitivity of any single technology. In the committee's view, the detect-to-warn biosensor application is extremely challenging for such detection technologies, primarily because they are presently too slow. Substantial basic research on nucleic acid detection has already been conducted, funded by many agencies, companies, and governments, but there has never before been an urgent reason to develop techniques that could respond in less than 1 minute. The committee's major findings and recommendations are as follows:

Finding 6-1: Sample preparation, including sample handling, transport, and system integration, represents the single most important challenge to be faced in the production of a detect-to-warn (DTW) system that performs an identification assay.

Recommendation 6-1: Support research on sample handling, transport, and system integration for assays that are compatible with DTW system requirements. This research may include, but is not limited to, the following:

- Fabrication and interconnection of miniature components and fluidics that serve DTW.
- Pressure-driven and electrophoretic transport.
- Acoustics or ultrasonics for sample handling and preparation.
- Dielectrophoresis for transport and separations.
- Surface-chemistry-based techniques for rapid cleanup and concentration of nucleic acids (such as described by the Boom patent).
- Manufacture and use of hybridization arrays for identification within a few seconds.

Finding 6-2: Neither the front end (sample collectors) nor the back end (fluorescent labels, diode lasers, and detection hardware) of nucleic acid sequence detection systems present fundamental obstacles to the development of detect-to-warn systems. However, even if it proves to be technically feasible to perform the detect-to-warn function in an autonomous fashion, the additional difficulty of manufacturing a reliable, fieldable autonomous system poses an important obstacle.

Recommendation 6-2: Support R&D on collection and detection systems that is consistent with overall system requirements for a detect-to-warn system. Special attention should be paid to the interfacing of modern, complex collector technologies with the sample handling system, avoidance of sampling errors

⁷² G.J. Olsen, D.J. Lane, S.J. Giovannoni, N.R. Pace, and D.A. Stahl. 1986. Microbial ecology and evolution: A ribosomal RNA approach. *Annu. Rev. Microbiol.* 40:337-365.

⁷³ At the very least, for example, one would not be able to distinguish between fully virulent *Bacillus anthracis* and a vaccine strain that is missing one or more plasmids.

(e.g., those that result from having low numbers of target sequences in the sample volume), miniaturization of components, and prevention of clogging in any system that would continuously sample the environment.

Finding 6-3: Highly stable reagents not only improve on the time a particular system may operate unattended but also may improve the overall reproducibility and reliability of the detection as well as the logistics and storage requirements to support the detector.

Recommendation 6-3: R&D should be conducted to develop reagents for nucleic acid assays with improved chemical stability.

Finding 6-4: Although a detect-to-warn system has its highest impact if it can initiate responses within approximately 1 minute of an attack, technologies that provide confirmation of the attack and identify the organisms involved will serve a vital function in the overall defensive architecture, even if their response times are several minutes.

Recommendation 6-4: R&D should be conducted to develop an integrated, fully automated PCR system, including sample collection, preparation, and analysis, initially with a 15-minute or so overall confirmation time and later with a 5-minute or so confirmation time.

Finding 6-5: Of the technologies considered, the determination of the sequence of unamplified target ribosomal RNA appears to offer the best potential for a 1-minute DTW system. However, cost and maintenance factors associated with required reagents would still be important issues.

Recommendation 6-5: Support research on an integrated assay for rapid sequence determination of ribosomal RNA (rRNA). This would include the selection of appropriate processing steps, their proper order, and minimum acceptable duration.

7

Structure-Based Identification for Detect-to-Warn Applications

Structure-based sensors—sometimes referred to as affinity-based sensors—represent a marriage of biology, biotechnology, physics, and instrumentation technology. Their function involves the following sequence of discrete steps:

- Direct binding of the target to a specific molecular recognition element,
- Transduction of the binding event into a measurable signal,
- Evaluation of that signal to determine the amount of target bound, and
- Use of that result to determine the amount of target present in the sampled environment.

The molecular recognition event is typically a specific interaction that is reversible, analogous to the interaction between a lock and a key, although in many cases the binding would more accurately be described as induced fit, during which the recognition element changes shape upon binding. This mode can be exploited in the sensor; detection of binding could rely on observation of that shape change. There are several factors that influence detection in signature-based sensors. These factors include the affinity of the target for the molecular recognition elements, nonspecific binding of extraneous material at the binding site, and the sensitivity of detection. Understanding how all these components influence the response of the sensing system is critical, especially when low (e.g., attomolar) detection limits are required. To achieve this goal, one should use high-affinity molecular recognition elements, reduce nonspecific binding by appropriate selection of the material that comes in contact with the sensor system, and employ high-sensitivity detection methods. Table 7.1 lists some transduction methods used in biosensors. The committee recognizes that many technologies involved in sensor signal transduction, such as optical fibers and waveguides, are rapidly evolving to enable the development of small, low cost, sensitive sensor systems. However, a review and evaluation of all sensor system transduction methods is beyond the scope of this report. Some specific examples of structure-based sensor systems that have been investigated for pathogen detection are given later in this chapter.

Table 7.2 lists some molecular recognition systems that could potentially be used for biothreat detection. DNA hybridization is another common molecular recognition approach used for biothreat detection. As it is covered in the previous chapter, it will not be repeated here.

TABLE 7.1 Transduction Modes in Biosensors

Transduction Mode and Device	Observed Output
Optical Fiber-optic and planar devices utilizing absorption, fluorescence, scattering, polarization, reflectivity, and/or interference of light	Changes in wavelength, intensity, emission profile, reflectivity, fringe patterns, polarization state, and refractive index.
Electrochemical Potentiometric devices (e.g., ion-selective electrodes), amperometric devices, and conductometric devices	Changes in voltage, current, impedance and/or resistance.
Gravimetric Acoustic wave devices, magnetic acoustic resonator sensors	Changes in mass and surface viscosity through shifts in frequency or phase of resonant vibrations.
Thermal Thermistor devices	Changes in temperature through shifts in electrical output.
Magnetic Magnetic field detectors	Changes in magnetic properties of paramagnetic particle reporters.

In many ways, structure-based biosensors mirror the highly effective *in vivo* processes that enable living organisms to respond appropriately to their environment. For example, cells respond rapidly and specifically to other cells, bacteria, viruses, hormones and other molecules and do so in proportion to the concentration of those signaling agents. In these signal transduction systems, the cell produces and displays its molecular recognition elements on its surface, embedded in its membrane. Each such element binds a specific target, usually to an extent that reflects the amount that is present. The binding activates a "reporter" function—usually a conformational change in the membrane-embedded molecular recognition molecule itself—that is then either detected directly or leads to a change in the molecular balance in the cell. Some structure-based sensors are modeled after biological systems, but are simpler, retaining only the specific binding components of the biological system. In general, they are easily replicated independent of the organisms (see Table 7.2 for some examples). The most common types of structure-based biosensors are immunosensors, which employ antibodies or antibody fragments as the recognition elements.¹ Antibodies are proteins that are generated within organisms to bind molecules (antigens) that the organism recognizes as foreign. Thus, they will bind to the surfaces of potentially dangerous viruses, cells, or nonbiological chemicals. Given that vertebrates produce in excess of 10^{11} different antibodies, it is highly likely that one or more antibodies can be found to bind any given target.

Antibodies have historically been produced by inoculating animals (often rabbits) with the target analyte of interest and isolating the antibodies from the serum or the specific cells that generate them. This is a relatively costly and laborious process, and methods have recently been developed for generating antibodies *in vitro*, without the inoculation of vertebrates. For example, methods have been developed for generating antibodies on the surface of a bacteriophage,² and a library of 10^9 human antibody fragments has been generated on the surface of yeast.³ Once these libraries of antibodies are

¹ B. Hock. 1997. Antibodies for immunosensors: A review. *Analytica Chimica Acta* 347:177-186.

P.B. Lippa, L.J. Sokoll, and D.W. Chan. 2001. Immunosenors: Principles and applications to clinical chemistry. *Clin. Chem. Acta* 314:1-26.

² I. Benhar. 2001. Biotechnological applications of phage and cell display. *Biotechnology Advances* 19:1-33.

³ M.J. Feldhaus, R.W. Siegel, L.K. Opresko, J.R. Coleman, T.M. Feldhaus, Y.A. Yeung, J.R. Cochran, P. Heinzelman, D. Colby, J. Swers, C. Graff, H.S. Wiley, and K.D. Wittrup. 2003. Flow-cytometric isolation of human antibodies from a nonimmune *Saccharomyces cerevisiae* surface display library. *Nature Biotechnology* 21:163-170.

TABLE 7.2 Molecular Recognition Systems for Biosensing

Molecular Recognition Element	Target Inhibitor	Comments
Single-stranded DNA	Complementary sequence of DNA	DNA hybridization is the basis for DNA biochip arrays and DNA amplification methods such as polymerase chain reaction (PCR), which are used for trace detection.
Antibody (a protein)	Proteins, carbohydrates, small organic molecules, etc.	Basis for immunoassays and immunosensors. Whole antibodies and parts of antibodies can now be developed in vitro.
Peptide (small part of a protein)	Proteins, carbohydrates, small organic molecules, etc.	Analogous to antibodies but much smaller and developed in vitro.
Enzyme (a protein)	Substrate (such biochemicals as urea, glucose, acetic acid).	Catalyzes the conversion of the substrate to a detectable product.
Lectin (a protein)	Carbohydrate	Lectins bind to polysaccharides on cell surfaces. Lectins typically bind to at least several types of organisms. This approach is expected to be most useful for sample preparation and general biodetection rather than for specific pathogen identification.
Receptor (a protein)	Proteins, carbohydrates, small molecules	In nature, receptors are often embedded in the membranes of cells. Ligand binding to a receptor causes a conformational change in the receptor that triggers detectable intracellular events.
Aptamer (a nucleic acid sequence)	Proteins, small organic molecules, etc.	Recognition is analogous to ligand-receptor binding, in contrast to sequence-specific hybridization between complementary strands of DNA.
Small molecules	Proteins, cells, etc.	Recognition is analogous to the interaction between an antibody and small antigen molecule; however, the small molecule is used as the molecular recognition element, and a biomolecule such as a protein on the surface of a cell is the target.
Imprinted polymers	Proteins, small organic molecules, whole cells, etc.	Under development but not yet proven for biodetection.

generated, high-throughput selection processes can be used to select the cells that contain antibodies that selectively bind the antigens of interest, and the selected cells can then be used to rapidly generate large quantities of the antibodies for sensor development. There is potential for these types of high-throughput in vitro methods to generate low-cost molecular recognition reagents for biothreat detection.

In addition to antibodies, a wide variety of other molecular recognition elements can be used for biosensing,⁴ some of which are summarized in Table 7.2. Many of these molecular recognition elements are proteins (e.g., enzymes, lectins, receptors), but some other types of molecular recognition elements under development may have properties (e.g., greater temperature and chemical stability) that make them better suited for use in environmental biosensors than are proteins. In the sections below, the committee describes the key features required for structure-based detection of biothreats, discusses some structure-based biosensor systems that have been investigated for biothreat detection, and highlights the areas that are promising and/or need development in order to achieve reliable operation in detect-to-warn situations, which will require rapid, reliable, and sensitive detection.

⁴ S.S. Iqbal, M.W. Mayo, J.G. Bruno, B.V. Bronk, C.A. Batt, and J.P. Chambers. 2000. A review of molecular recognition technologies for detection of biological threat agents. *Biosensors and Bioelectronics* 15:549-578.

THE STRUCTURE-BASED BIOSENSOR: BASIC ELEMENTS

Implementation of a structure-based sensor involves performing several steps in sequence:

- Sample collection,
- Sample concentration,
- Binding of the target to the molecular recognition element,
- Possible addition and removal of "reporter" groups,
- Detection of target molecular recognition element complex,
- Analysis of the output signal, and
- Renewal of the sensor surface for repeated monitoring.

Each of these steps imposes its own unique constraints on the system, as discussed below.

Sample Collection

As in the case of all other sensors, the first step in identifying a foreign agent involves the collection of the sample. Much of the discussion of collection methods in Chapter 4 applies directly to structure-based biosensors. It is critical, however, that the process of collection not alter the structure of that portion of the target that is to be bound by the molecular recognition element. Thus, cell surface proteins, or protein toxins in particular, must not be denatured in the collection process.

For some sensors, particularly those that are function-based (see Chapter 9), there is concern that the collection process might damage or kill the cellular target. This is not likely to be a problem with structure-based sensors. The molecular-level cell surface structures to be bound typically appear repeatedly on the surface of the cellular target and, individually, cover a very small area. Thus even if the cell surface were disrupted, the surface structures would remain intact, albeit on many particles (rather than one), and would retain their ability to bind the molecular recognition elements.

The breaking of the cells could introduce other factors, however. One possibility is that this could release large numbers of molecules from inside the cell that are common to a variety of organisms and may resemble surface molecules and compete with them for the binding sites. Other interfering components that could be released upon breaking of cells are proteases. Proteases are enzymes that will interfere with the detection of proteinacious components, and they could also hydrolyze protein-based reagents. On the other hand, fragmentation could simplify the molecular recognition element's access to the binding site or even expose unique groups that were inaccessible in whole, intact cells.

Collection techniques that kill cellular targets would not typically bring about structure-based detection. Dead cells generally exhibit the same surface molecules as live cells. This actually confers an advantage for structure-based sensors compared with those that depend on target cell function, in that there would be more targets to bind and detect. The presence of dead cells would usually indicate the presence of live cells elsewhere in the sample or physical environment from which the sample was taken, so their detection is often of value.

Sample Concentration

Sample concentration is a significant consideration for structure-based recognition. Currently deployed immunosensors typically require 10^4 binding events or more for detection. Therefore, to attain a detection threshold of 10 to 100 agent-containing particles per liter of air (ACPLA) or better, these sensors must collect and concentrate thousands of liters of air. For example, once triggered, the Joint Biological Point Detection System (JBPDS) collects air at 800 liters per minute for 2.5 minutes before conducting immunoassays. This time would have to be shortened in order to achieve a total detect-to-warn time (from sample collection to answer) of 1 minute or less. Fortunately, improvements in structure-based assays have the potential to improve the level of detection (LOD) to 100 (or even fewer) binding events. If actualized, this will greatly reduce the demand on the collector/concentrator prior to detection.

Sample purification also must be considered, especially if there is a desire to obtain low detection limits in samples with a high background concentration of particles. Sample components that nonspecifically bind to a sensor surface can effectively block binding sites. In some sensor configurations, nonspecific binding of matrix components also contributes a background signal, which can result in a false positive if the matrix composition changes over time.

Binding of Target to the Molecular Recognition Element

To meet the constraints for detect-to-warn systems that report in 1 to 2 minutes, the binding of the molecular recognition elements, the target, and other required reagents must occur as quickly as possible. If there are multiple binding steps required for detection, the time constraints for each binding step are even more severe.

There have been many reports investigating the kinetics of binding targets to molecular recognition elements immobilized onto biosensor surfaces.⁵ These results show that under flowing conditions and with sufficient target concentration, detectable one-step binding can be achieved in a few seconds.^{6,7,8} However, the results to date indicate that 1-minute analysis time is a challenge and will require a sensor design that minimizes the number of binding and processing steps and enhances mass transport of the target to the sensor surface.

For example, it has been shown that at a protein concentration of 1 microgram per milliliter (about 7 nanomoles for a protein of 150,000 daltons), protein binding to an antibody-coated sensor can be detected within 20 seconds when the sample is flowing over the sensor surface.⁹ However, several minutes were required to achieve a response that was 50 percent of the steady-state response. The response would be faster if the target concentration were higher, if the rate of target transport to the sensor surface were increased, or if the target were smaller in size (to increase its rate of diffusion to the sensor surface). The time required to obtain a detectable signal can be several minutes or longer if there is no flow, if the target concentration is further decreased, and/or if the target diffuses slowly in the sample fluid and artificial mixing cannot be achieved.¹⁰

-
- ⁵ A. Sadana. 1998. An analysis of analyte-receptor binding kinetics for biosensor applications: Influence of the fractal dimension on the binding rate coefficient. *Biosensors and Bioelectronics* 13:1127-1140.
 Y.Y. Yu, B.J. Van Wie, A.R. Koch, D.F. Moffett, and W.C. Davis. 1998. Real-time analysis of immunogen complex reaction kinetics using surface plasmon resonance. *Analytical Biochemistry* 263:158-168.
 B. Goldstein, D. Coombs, X. He, A.R. Pineda, and C. Wofsy. 1999. The influence of transport on the kinetics of binding to surface receptors: Application to cells and BIAcore. *J. Mol. Recognit.* 12:293-299.
 R.A. Vijayendran, F.S. Ligler, and D.E. Leckband. 1999. A computational reaction-diffusion model for the analysis of transport-limited kinetics. *Anal. Chem.* 71:5405-5412.
 A. Ramakrishnan and A. Sadana. 2000. An evaluation of cellular analyte-receptor binding kinetics utilizing biosensors: A fractal analysis. *J. Colloid. Interface Sci.* 224:219-230.
 H.P. Jennissen and T. Zumbink. 2001. Mass transport-free protein adsorption kinetics in biosensor systems. *FASEB Journal* 15:A531.
 A. Sadana. 2001. A kinetic study of analyte-receptor binding and dissociation, and dissociation alone, for biosensor applications: A fractal analysis. *Analytical Biochemistry* 291:34-47.
 K.E. Sapsford, Z. Liron, Y.S. Shubin, and F.S. Ligler. 2001. Kinetics of antigen binding to arrays of antibodies in different sized spots. *Anal. Chem.* 73:5518-5524.
 Y.S.N. Day, C.L. Baird, R.L. Rich, and D.G. Myszka. 2002. Direct comparison of binding equilibrium, thermodynamic, and rate constants determined by surface- and solution-based biophysical methods. *Protein Sci.* 11:1017-1025.
 C.C. Fong, M.S. Wong, W.F. Fong, and M. Yang. 2002. Effect of hydrogel matrix on binding kinetics of protein-protein interactions on sensor surface. *Analytica Chimica Acta* 456:201-208.
 P. Gomes and D. Andreu. 2002. Direct kinetic assay of interactions between small peptides and immobilized antibodies using a surface plasmon resonance biosensor. *Journal of Immunological Methods* 259:217-230.
- ⁶ A. Sadana and A. Ramakrishnan. 2002. A kinetic study of analyte-receptor binding and dissociation for biosensor applications: A fractal analysis for cholera toxin and peptide-protein interactions. *Sens. Actuator B-Chem.* 85:61-72.
- ⁷ M. Abrantes, M.T. Magone, L.F. Boyd, and P. Shuck. 2001. Adaptation of a surface plasmon resonance biosensor with microfluidics for use with small sample volumes and long contact times. *Anal. Chem.* 73:2828-2835.
- ⁸ Sapsford et al., 2001. See note 5 above.
- ⁹ Sapsford et al., 2001. See note 5 above.
- ¹⁰ Vijayendran et al., 1999. See note 5 above.

The relationship between target concentration and analysis time has implications for biodetection in detect-to-warn situations, because to rapidly detect trace concentrations, it is necessary to transport the target to the biosensor surface rapidly and therefore to increase the target concentration near the sensor surface. In addition, even for the example above (1 microgram per milliliter protein target), in which a signal was detectable in a few seconds (and within the 1 minute time constraint), a much larger detection signal could be obtained by locally increasing the target concentration at the sensor surface. A larger signal would be desirable to increase the signal-to-noise ratio and therefore decrease the number of false positives and also to improve the sensitivity to low concentration. In fact, the committee expects that detect-to-warn applications will require the detection of concentrations at least as low as 1 nanogram per milliliter (about 10 pM, or 10^{-12} moles per liter) for toxins and concentrations on the order of attomoles (10^{-18} moles per liter) for other biothreats (for examples, see Boxes 7.1 and 7.2).

One method of avoiding transport-limited kinetics is to increase the flow rate. However, this is not always feasible since it requires larger sample volumes. Oscillatory flow has been shown to perform just as well as increasing the flow rate in some situations, resulting in detectable signals in a few seconds.¹¹ Some other methods that could be used to transport the analyte to the sensor surface include ultrasonic focusing, electrophoretic focusing, and centrifugation. All of these methods have inherent limitations that depend upon factors such as the molecule size and surface charge, so the method of choice depends upon the analyte to be detected and the composition of the sample matrix.

Specific Detection and False Alarms

Specificity is also a critical issue, especially when the identification of biothreats is desired. The choice of biomarkers for detection will determine the potential selectivity of a structure-based bioagent detector. For example, if one develops antibodies or aptamers for cell surface epitopes that are present on all *Bacillus* species, even a perfectly operating sensor will respond to all *Bacillus* species and not specifically to *Bacillus anthracis*. However, if one develops a structural recognition element for a virulence marker protein, with proper sample preparation, the virulence marker protein will be detected, even if the virulence is engineered into a completely different organism. Therefore, careful selection of biomarkers and the use of multiple biomarkers are important considerations to enable specific bioagent detection. Research to determine the appropriate biomarkers for bioagents of interest and develop structural recognition elements for those biomarkers is critical for selective bioagent detection.

Another important consideration for sensor specificity is the binding of untargeted substances to the sensor surfaces. Binding of nontarget substances will result in false positive responses and is likely to be caused by two major factors: (1) the difficulty in achieving absolute specificity on the part of the molecular recognition elements and (2) the ubiquitous, nonspecific binding of extraneous material in the sample to the molecular recognition element or to the surfaces of the sensor itself. Both of these undesirable effects can be mitigated with improved design. In the former case, for example, it is known that extremely specific proteins can be designed, as shown by the existence of the exceptionally high specificity of proteolytic enzymes involved in blood clotting or proenzyme activation. In the latter case, engineering of the sample or the surfaces of the sensor, or adjustment of the pH, ionic strength, or other conditions of the assay, would likely be of great value.

Lack of specificity could also be mitigated if the system is designed to respond not to a single binding event but to two or more that arise independently. In one such scheme, two or more molecular recognition elements would be used, each designed to bind to its own distinct target epitope (binding structure on the target). A positive response would be recorded only when all recognition elements are bound simultaneously. Since each binding event is independent of the other, and they occur in parallel,

¹¹ Abrantes et al., 2001. See note 7 above.

Box 7.1**Notional Structure-Based Detection and Identification System:
Reliable Level of Detection at 10,000 Targets Bound to the Sensor Surface**

Below, the committee outlines a detection system that includes system components that are only slightly beyond what has already been demonstrated in a few laboratory systems. This notional system highlights the fact that a dramatic improvement in system-level detection limit beyond what is now achievable is desirable for detection in 2 minutes or less. This notional system assumes that an approximately 1 femtomolar concentration of analyte (3×10^4 analyte molecules in 50 microliters) is required for reliable detection. This detection limit has been demonstrated using several structure-based detection systems currently available.

Sample Collection

- Collect the sample for 400 seconds from the air into an aqueous solution using a two-stage, precollection fractionator with an overall capture efficiency of 50 percent and a collection rate of 90 liters of air per minute into 50 microliters of aqueous volume.^a An air sample with 100 target structures per liter would be concentrated to 30,000 spores in a 50 microliter solution.^b
- Bind molecules to the sensor surface over 20 seconds via an active transport mechanism (e.g., pressure, electrophoretic transport, ultrasonic focusing) that moves the analyte to the sensor surface. About 10,000 analyte molecules bind to the sensor surface.
- Wash the sensor surface for 10 seconds.

Reporter Group (Optimal)

- Deliver reporter to sensor surface over 20 seconds.

Detection

- Detect the presence of the 10,000 analyte molecules within 2 seconds.

Regeneration

- Wash the sensor surface for 10 seconds.

Total analysis time is 7 minutes, 42 seconds with all options, and 7 minutes, 2 seconds for direct detection without washing or the need for a reporter. This would not meet the needs of a detect-to-warn system. In both cases, most of the time is dedicated to collecting and concentrating the sample. However, if multiple targets are present on the organism, it may be possible to dramatically shorten the analysis time by lysing the organism to generate multiple, separate targets for detection. The initial steps might then become:

- Collect for 4 seconds, resulting in 300 spores in 50 microliters.
- Lyse organisms for 10 seconds to generate 100 targets from each spore (30,000 total targets).

This possibility would dramatically shorten the time for the collection of 30,000 targets from 6 minutes, 40 seconds (without lysis) to 14 seconds (with lysis) and would reduce the total analysis time to 1 minute, 16 seconds. This is well within the range of detect-to-warn requirements. Similarly, in some detection schemes and with some organisms, multiple targets can be detected on each organism without lysis, resulting in greater levels of sensitivity.

^a Collection of aerosol directly into a liquid can be replaced by collection of dry aerosol onto a surface such as a sample tube, followed by addition of liquid for the detection assay (e.g., see B cell example in the "Modified Cell-Based Systems" section of this chapter).

^b Many structure-based detection systems report detection limits ranging from picomolar to nanomolar concentrations, which would require increasing the collection time by three to six orders of magnitude in this example. The resulting collection times required to achieve a detection limit of 100 ACPLA would therefore range from about 4,000 to 4,500 days, which is certainly much longer than needed for detect-to-warn (and many other) applications.

Box 7.2**Notional Structure-Based Detection and Identification System:
Reliable Level of Detection at 100 Targets Bound to the Sensor Surface**

Below, the committee outlines a detection system that is based on a level of detection that has been demonstrated in the best laboratory systems (e.g., see CANARY B cell example in the text). This notional system assumes that approximately 300 targets (or cells/spores/viruses) must be collected in 50 microliters for reliable, rapid detection. This corresponds to a molar target concentration of about 10×10^{-18} M (10 aM).

- Collect the sample over 4 seconds from the air into a Joule aqueous solution, using a two-stage, precollection fractionator with an overall capture efficiency of 50 percent and a collection rate of 90 liters of air per minute;^a 100 spores/liter of air would produce 300 spores in 50 μ L solution.
- Wait 20 seconds for an active transport mechanism (e.g., pressure, electrophoretic transport) to move the analyte to the sensor surface; about 100 analyte molecules bind to the sensor surface.

Optional steps depend upon assay format and transduction method:

- Wash the sensor surface for 10 seconds.
- Deliver reporter to sensor surface over 20 seconds.
- Wash the sensor surface for 10 seconds.
- Wait 2 seconds to detect the presence of the 100 analyte molecules.

The total analysis time is 1 minute, 6 seconds with all options and would be 26 seconds for direct detection without washing or the need for a reporter. This would therefore meet the needs for a detect-to-warn system. Analysis of only 10 ACPLA could be achieved by increasing collection time by 36 seconds, resulting in a total analysis time that is still less than 2 minutes for this example. Also, note that the total analysis time doubles to 76 seconds with the addition of binding and washing steps for adding one reporter group.

^a Collection of aerosol directly into a liquid can be replaced by collection of dry aerosol onto a surface such as a sample tube, followed by addition of 50 microliters liquid for the detection assay (e.g., see CANARY B cell example).

this scheme would not slow the rate of response. The reduction in false positives could, however, be dramatic. Two binding sites that individually produce false positives once in 10^3 events would, together, give a false alarm only once in 10^6 events. Three elements would be expected to have a false alarm once in 10^9 events. This is especially important for continuously operating detect-to-warn systems. Even a low false alarm rate of 10^{-3} would result in an alarm about every 20 hours on average, if the system is cycled once every minute. A false alarm rate of 10^{-6} would result in an alarm only about once every 2 years.

This advantage of parallel sensor design to minimize false alarms will only be realized if the false alarms are not correlated to one another. For example, if the nonspecific binding of matrix material systematically produces false alarms in all sensor elements (e.g., all SPR sensors that will detect nonspecifically bound proteins), the false alarm rate due to this factor would not be improved. (However, a control sensor surface without the selective chemistry can be used to normalize the sensor signal and minimize the effects of matrix materials.) Of somewhat less value would be the deployment of several different types of structure-based sensors using independent binding and detection schemes.

Addition and Removal of Reporter Groups

In many sensor systems, binding is detected only through the presence of a separate reporter group—for example, a fluorescent, magnetic, or other type of tag. In other systems, e.g., optical techniques such as surface plasmon resonance, target binding is detected directly, so that the analyte itself is also the reporter. The use of reporter groups adds some complexity to the system, because separate steps are typically required for their binding and also for washing to remove nonspecifically bound and unbound reporters from the sensor surface. Any additional binding steps are governed by the same transport and reaction kinetics described above for the binding of the molecular recognition element.

In general, surface-sensitive detection methods are desirable, because these methods will only detect the reporters at or near the sensor surface and not the unbound reporters in the bulk solution. Surface-sensitive methods have the potential to provide a more rapid response than bulk detection methods, because detection can be measured without the requirement that the unbound reporter be washed from the sensing surface. When bulk detection methods are used, the sensor detects the reporter whether or not it is bound to the target, necessitating the additional wash. Some common surface-sensitive detection methods include surface plasmon resonance devices, optical detection systems utilizing evanescent waves for optical excitation from optical fibers or waveguides, and acoustic wave devices. Some magnetic detection schemes ignore unbound reporters.¹²

Even more desirable is a method in which only specifically bound reporters (and not the nonspecifically bound reporters) are detected. In this case, the false positive rate will decrease, and the limit of detection may also improve. This could occur, for example, if the reporter reacts with the target to generate a detectable signal and reaction only occurs upon specific binding of the reporter with the target.

Wash steps not only take time but also can lead to the dissociation of the target molecular recognition element complex and result in a reduced signal. It is therefore important that the target molecular recognition complex be stable. This is often the case for structure-based molecular recognition systems. For example, while antigen binding occurs in seconds, antigen removal with gentle washing occurs in many minutes to hours. This is because for high-affinity binding, the rate of binding is many orders of magnitude greater than the rate of dissociation.¹³ Other molecular recognition elements can be designed with similar properties.

Detection of Target Molecular Recognition Element Complex

A variety of signal transduction methods (Table 7.1, and also see Box 8.2 in Chapter 8) have been proposed for the detection and reporting of the target molecular recognition element (reporter) complex.¹⁴

¹² Y.R. Chemla, H. L. Grossman, Y. Poon, R. McDermott, R. Stevens, M.D. Alper, and J. Clarke. 2000. Ultrasensitive magnetic biosensor for homogeneous immunoassay. *Proc. Natl. Acad. Sci.* 97:14268-14272.

¹³ Hock, 1997. See note 1 above.

Vijayendran et al., 1999. See note 5 above.

¹⁴ A. Guiseppi-Elie and A.M. Wilson. 1995. Electroconductive polymer thin films with bioactive moieties for biosensor applications. *Polym. Mater. Sci. Eng.* 72:404-405.

F.W. Scheller, F.F. Bier, and D. Pfeiffer. 1995. Biosensors: Principles and applications. *Technisches Messen* 62:213-219.

J.H. Kim. 1997. Research trends in biosensors. *Hwahak Sekye* 37:23-32.

J. Rishpon and D. Ivnitiski. 1997. An amptronic enzyme-channeling immunosensor. *Biosensors and Bioelectronics* 12:195-204.

D.R. Baselet, G.U. Lee, M. Natesan, S.W. Metzger, P.E. Sheehan, and R.J. Colton. 1998. A biosensor based on

magnetoresistance technology. *Biosensors and Bioelectronics* 13:731-739.

P.M. Fratamico, T.P. Strobaugh, M.B. Medina, and A.G. Gehring. 1998. Detection of *Escherichia coli* O157: H7 using a surface plasmon resonance biosensor. *Biotechnol. Tech.* 12:571-576.

J.C. Pyun, H. Beutel, J.U. Meyer, and H.H. Ruf. 1998. Development of a biosensor for *E-coli* based on flexural plate wave transducer. *Biosensors and Bioelectronics* 13:839-845.

I. Abdel-Hamid, D. Ivnitiski, P. Atanasov, and E. Wilkins. 1999. Flow-through immunofiltration assay system for rapid detection of *E-coli* O157:H7. *Biosensors and Bioelectronics* 14:309-316.

D. Ivnitiski and I. Abdel-Hamid. 1999. Biosensors for detection of pathogenic bacteria. *Biosensors and Bioelectronics* 14:599-624.

Chemla et al., 2000. See note 12 above.

Many of these transduction methods are extremely fast, and the analysis of the signal should also be very fast. Thus, so long as transport and binding are fast, detection can be achieved in less than 1 minute. However, the system needs to be sufficiently automated so that cleaning and preparation of the instrument and loading of the next sample are not too time consuming.

Renewal of the Sensor Surface for Continuous Monitoring

For continuous use of a sensor, the rate of molecular recognition element (MRE) target must be tuned to regenerate the sensor surface at the end of an analysis. This is sometimes achieved by changing the wash conditions to disrupt the interaction between the target and the molecular recognition element. The stringent washing must remove bound target and nonspecifically bound materials but leave the molecular recognition element unaffected. Renewal of the sensor surface is typically only possible for a limited number of cycles, after which time the sensor surface must be replaced due to degradation.¹⁵ Therefore, molecular recognition elements that can withstand harsh washing procedures are desirable to enable repeated renewal of the sensor surface.

CONSUMABLES CONSIDERATIONS FOR DETECT-TO-WARN APPLICATIONS

Both the cost and amounts of consumables must be minimized for detect-to-warn applications, which require near-continuous operation. For example, if an analysis is done every 2 minutes, 720 assays will be completed each day, and 256,320 assays will be done each year. Therefore, even a consumables cost of only 4 cents per assay will add up to over \$10,000 per sensor per year. Current assay costs are between one and two orders of magnitude higher than this cost. However, the committee expects that it will be possible to decrease the consumables cost per assay to 4 cents per assay or less by decreasing the size of the sensor systems and total liquid volumes to 100 microliters or less per sample and by the development of novel, low-cost reagents and methods for selective binding and detection.

The consumables costs include all reagents required for detection and system cleaning, and also the cost of generating and maintaining the selective sensing surface itself. It is known that repeated use of a structure-based sensing surface will require repeated cleaning (and therefore consumables) to remove nonspecific and specifically bound materials. In addition, degradation of a sensing surface typically occurs after repeated use, so that methods will have to be developed for periodic automated replacement of the sensing surface (or complete replacement of the sensor). For example, a sensor that can be reused 100 times would be replaced 2,500 times a year, and a sensor that can be reused 1,000 times would be replaced 250 times per year.

-
- E. Howe and G. Harding. 2002. A comparison of protocols for the optimization of detection of bacteria using a surface acoustic wave biosensor. *Biosensors and Bioelectronics* 15:641-649.
- W.M. Mullett, E.P.C. Lai, and Y.M. Yeung. 2000. Surface plasmon resonance-based immunoassays. *Methods* 22:77-91.
- S.T. Pathirana, J. Barbaree, B.A. Chin, M.G. Hartell, W.C. Neely, and V. Vodyanoy. 2000. Rapid and sensitive biosensor for Salmonella. *Biosensors and Bioelectronics* 15:135-141.
- C. Aston. 2001. Biological warfare canaries. *IEEE Spectrum* (October):35-40.
- P. Ertl and S.R. Mikkelsen. 2001. Electrochemical biosensor array for the identification of microorganisms based on lectin-lipopolysaccharide recognition. *Anal. Chem.* 73:4241-4248.
- A.P. Ferreira, M.M. Werneck, and R.M. Ribeiro. 2001. Development of an evanescent-field fibre optic sensor for Escherichia coli O157: H7. *Biosensors and Bioelectronics* 16:399-408.
- J.B. Delehanty and F.S. Ligler. 2002. A microarray immunoassay for simultaneous detection of proteins and bacteria. *Anal. Chem.* 74:5681-5687.
- F.L. Dickert and O. Hayden. 2002. Bioimprinting of polymers and sol-gel phases: Selective detection of yeasts with imprinted polymers. *Anal. Chem.* 74:1302-1306.
- C. Ercole, M. Del Gallo, M. Pantalone, S. Sartucci, L. Mosiello, C. Laconi, and A. Lepidi. 2002. A biosensor for Escherichia coli based on a potentiometric alternating biosensing (PAB) transducer. *Sens. Actuator B-Chem.* 83:48-52.
- Z.Z. Li, F.C. Gong, G.L. Shen, and R.Q. Yu. 2002. Bacteria-modified amperometric immunosensor for a Brucella melitensis antibody assay. *Analytical Sciences* 18:625-630.
- F.S. Ligler, M. Breimer, J.P. Golden, D.A. Nivens, J.P. Dodson, T.M. Green, D.P. Haders, and O.A. Sadik. 2002. Integrating waveguide biosensor. *Anal. Chem.* 74:713-719.
- ¹⁵ M.A. Gonzalez-Martinez, R. Puchades, and A. Maquieira. 1999. On-line immunoanalysis for environmental pollutants: From batch assays to automated sensors. *Trends in Anal. Chem.* 18:204-218.

In addition to the cost of consumables, there are practical engineering and deployment challenges related to the use of consumables. Both structure-based and sequence-based detection approaches require a water environment for specific binding. If only 100 microliters of aqueous solution are used per analysis (e.g., 50 microliter volume for aerosol collection plus 50 microliters for additional processing and washing), 2 liters of liquid would be used and accumulated each month, and 25 liters of liquid would be used each year. Therefore, current approaches that use a total liquid volume on the order of 1 milliliter per analysis are not suitable for detect-to-warn applications. With significant investments in structure-based sensor development, the committee believes that novel approaches that use small volumes of liquid per analysis are technically achievable for detect-to-warn applications (see Box 7.1 regarding needs for aerosol collection into small volumes).

It is also conceivable that specific structure-based detection could be conducted on a sensing surface that includes a water environment (e.g., hydrogel or liquid droplets) containing all reagents for the structure-based assays. The sensor surface could then directly accumulate aerosol particles for each analysis, and a fresh surface would be used for each analysis (analogous to moving tape matrix-assisted laser desorption/ionization/mass spectrometry (MALDI-MS) systems under development). While such an approach may be feasible, there are many science and engineering challenges to realizing such a system. While structure-based detection is capable of rapid detection for detect-to-warn applications, future research is needed to develop novel detection concepts that minimize reagent volumes, minimize disposables, and decrease the cost per assay.

NOTIONAL STRUCTURE-BASED DETECTION SYSTEMS

In considering potential approaches for detect-to-warn applications, it will be useful to compare systems and approaches described throughout the rest of this chapter to the two notional systems described in Boxes 7.1 and 7.2. These estimate the analysis time for two different detection limits: (1) one femtomolar (about 10,000 targets bound to the sensor surface, see Box 7.1) and (2) 10 attomolar (about 100 targets bound to the sensor surface, see Box 7.2). These situations were selected because 10^4 molecules bound to the sensor surface (Box 7.1) is a detection level that is reported for many commercially available structure-based detection systems and other systems under development. A detection level of 100 molecules bound to the sensor surface (Box 7.2) has been reported for a few systems under development and is therefore expected to be reasonably attainable in the near future.

In both examples, an overall system-level detection limit of 100 ACPLA in air was used, and an aerosol sampling rate that is consistent with the notional examples presented in Chapter 6 was assumed (90 liters per minute collection into 50 μ L liquid with 50 percent efficiency). These notional examples highlight several important points:

- For detect-to-warn applications (detection in 2 minutes or less), a very sensitive detection limit (tens of attomolar concentration, or about 100 targets bound to the sensor) is required in order to shorten the aerosol collection time.
- Detection time can be decreased dramatically by decreasing the number of processing steps.
- Transport of the targets (and also detector molecules if they are used) close to the sensing surface is an important consideration to allow binding and washing steps that each require only 10 to 20 seconds or less.
- These notional systems have been carefully prepared and are presented in terms of specific numerical levels of target number, target concentration, sample volume, concentration efficiency, and time. No meaningful discussions of various recognition elements and signal transduction systems can take place unless these numbers are available for each system to be evaluated.

DETAILED CONSIDERATIONS: MOLECULAR RECOGNITION ELEMENTS

The heart of the biosensor is the molecular recognition element that must, with high affinity and selectivity, bind a target that might often be found in low concentrations in a complex mix of similar structures. In discussing the alternative molecular recognition elements listed in Table 7.2, a number of critical factors must be evaluated, including specificity, affinity (both rates of association and dissociation), stability, and manufacturability (e.g., cost, time for production, storage requirements, and lifetime).

Antibodies

The classical molecular recognition elements, antibodies, are produced by most vertebrates. Roughly 10^{11} different antibodies are produced by each organism and can be found circulating in its blood stream. Well-established techniques exist for isolating large quantities of a single antibody that binds a specifically defined target (antigen).¹⁶ The screening of blood from suitably immunized animals allows the collection of polyclonal antibodies, a population of a number of different antibodies, each of which can bind the target, albeit with its own characteristic binding constant (which can vary over several orders of magnitude). Other techniques allow for the selection of a single, monoclonal antibody against the target.

Antibody binding constants are quite variable depending on the target and the method used to raise the antibodies. This provides valuable flexibility in sensor design. Some applications would benefit from low-specificity antibodies that could bind any of a family of targets. In other cases, high specificity is required. Precedent exists for this: Some proteolytic enzymes—for example, digestive enzymes—have very little substrate discrimination, hydrolyzing the peptide bond between amino acids regardless of the nature of those or neighboring amino acids. Other enzymes, often with similar structures and mechanisms of action, can be exceptionally specific—for example, those that activate the blood clotting system or cleave the polyprotein precursors of viruses such as HIV. Some antigens appear to present significant difficulties in the development of high-affinity antibodies, although techniques do exist to mitigate these problems. Naturally occurring antibodies can be used, but recently developed techniques of "antibody evolution" allow for the selection of antibodies with increasingly high affinities.

Techniques have recently been developed for generating antibodies *in vitro*, without the inoculation of vertebrates. For example, methods have been developed for generating antibodies on the surface of bacteriophages (viruses that infect bacteria),¹⁷ and a library of 10^9 human antibody fragments has been produced on the surface of yeast.¹⁸ Each yeast cell virus produces a single antibody, and once these libraries of antibodies are generated, high-throughput selection processes can be used to select the individual cells that produce the antibody that selectively binds the antigen of interest, and the selected cells can be used to rapidly generate large quantities of the antibodies for sensor development.

Because antibodies are proteins, questions about storage and stability must be addressed. Small variations in temperature, pH, and ionic strength can lead to denaturation (the unfolding of the three-dimensional structure of the antibody) and the loss of its ability to bind its target antigen. In addition, the ubiquitous presence of proteolytic enzymes, which degrade proteins, can severely limit antibody lifetimes.

¹⁶ Hock, 1997. See note 1 above.

L.M. Houdebine. 2002. Antibody manufacture in transgenic animals and comparisons with other systems. *Curr. Opin. Biotechnol.* 13:625-629.

C.R. Suri, M. Raje, and G.C. Mishra. 2002. Immunosensors for pesticide analysis: Antibody production and sensor development. *Crit. Rev. Biotechnol.* 22:15-32.

T.J. Torphy. 2002. Pharmaceutical biotechnology: Monoclonal antibodies, boundless potential, daunting challenges. *Curr. Opin. Biotechnol.* 13:589-592.

¹⁷ S.S. Sidhu. 2000. Phage display in pharmaceutical biotechnology. *Curr. Opin. Biotechnol.* 11:610-616.

I. Benhar. 2001. Biotechnological applications of phage and cell display. *Biotechnology Advances* 19:1-33.

R.H. Hoess. 2001. Protein design and phage display. *Chemical Reviews* 101:3205-3218.

B. Zhou, P. Wirsching, and K.D. Janda. 2002. Human antibodies against *Bacillus*: A model study for detection of a protection against anthrax and the bioterrorist threat. *Proc. Natl. Acad. Sci.* 99:5241-5246.

¹⁸ M.J. Feldhaus, R.W. Siegel, L.K. Opresko, J.R. Coleman, T.M. Feldhaus, Y.A. Yeung, J.R. Cochran, P. Heinzelman, D. Colby, J. Swers, C. Graff, H.S. Wiley, and K.D. Wittrup. 2003. Flow-cytometric isolation of human antibodies from a nonimmune *Saccharomyces cerevisiae* surface display library. *Nature Biotechnology* 21:163-170.

The Defence Science and Technology Laboratory (Dstl) in the United Kingdom reports the use of antibodies with better than 90 percent maintenance of activity over 30 hours in their optical evanescent biosensors for ricin.¹⁹ In other systems—for example the antibodies for Staphylococcus enterotoxin B proteins—the antibodies were reported to lose half of their activity after only 3 hours.²⁰ In addition, the washing conditions required to remove bound antigens and regenerate an antibody sensor surface are known to degrade many antibodies over time.²¹ Therefore, for detect-to-warn applications that require continuous monitoring, the development of robust antibody fragments for molecular recognition and the development of alternative molecular recognition elements that are more rugged and have longer lifetimes than antibodies are desirable to decrease the cost of repeatedly renewing the sensing surfaces and the complexity of the final sensor system.

Aptamers

Aptamers are oligomers of RNA or DNA that spontaneously fold into specific three-dimensional shapes that can bind defined targets. The specificity of the shape of the binding site arises from the base sequence of the aptamer, which determines the base-pairing pattern of the oligomer. The prototypical, proof-of-principle example of how this base pairing and three-dimensional folding within a single nucleic acid molecule can create specific binding sites is the complex and distinctive L-shaped structure of transfer RNA (tRNA). This molecule has regions of base pairing and regions that are single-stranded. Both are critical to its role in protein synthesis. Molecules of tRNA with 20 distinct binding sites are produced, each having its own exceptional specificity for binding an acylating enzyme and amino acid.

Aptamers are easily synthesized through the use of automated machines that can produce oligomers of desired sequence and length, and automated methods have been developed to select aptamers with high affinity to targets of interest.²² Typically, aptamers have about 40 bases. With 4 different bases available, 440 possible sequences can be generated. In practice, libraries of 10^{15} members are made for screening against targets. The nucleotide sequences of those that bind well are determined, and large numbers of variants of those "leads" are produced to optimize binding. The process is repeated, yielding molecules with greater specificity and binding strength at each cycle. This systematic evolution of aptamers can be highly successful, as has been shown for the development of RNA aptamers that bind to the protein bacteriophage T4 DNA polymerase.²³ Known sequences of DNA are typically added at the ends of the 30 to 40 base aptamers to allow PCR amplification for the production of many copies of a selected aptamer. Aptamers have also been modified to resist nuclease digestion and thereby exhibit extended stability. A variety of technical modifications such as the cross-linking of two aptamers that bind to different parts of a target are being investigated.²⁴

Aptamer technology provides additional opportunities in terms of the design of molecular recognition elements that could have affinities and selectivities that complement those of the more traditional antibody reagents. In some cases DNA aptamers have been reported to have higher affinities than antibodies.²⁵ Aptamers also are reported to have greater stability and a longer shelf life than proteins

¹⁹ Peter Biggins, Dstl. Presentation to the committee on June 12, 2002.

²⁰ Biggins, 2002. See note 19 above.

²¹ Gonzalez-Martinez et al., 1999. See note 15 above.

²² B.E. Eaton, L. Gold, B.J. Hicke, N. Janjic, F.M. Jucker, D.P. Sebesta, T.M. Tarasow, M.C. Willis, and D.A. Zichi. 1997. Post-SELEX combinatorial optimization of aptamers. *Bioorg. Med. Chem.* 5:1087-1096.

J.C. Cox and A.D. Ellington. 2001. Automated selection of anti-protein aptamers. *Bioorg. Med. Chem.* 9:2525-2531.

L.J. Sooter, T. Reidel, E.A. Davidson, M. Levy, J.C. Cox, and A.D. Ellington. 2001. Toward automated nucleic acid enzyme selection. *Biol. Chem.* 382:1327-1334.

²³ C. Tuerk and L. Gold. 1990. Systematic evolution of ligands by exponential enrichment: RNA ligands to bacteriophage-T4 DNA-polymerase. *Science* 249:505-510.

²⁴ E.N. Brody, M.C. Willis, J.D. Smith, S. Jayasena, D. Zichi, and L. Gold. 1999. The use of aptamers in large arrays for molecular diagnostics. *Molecular Diagnostics* 4:381-388.

²⁵ L. Gold, Somalogic. Presentation to the committee on June 13, 2002.

such as antibodies. In addition, as with proteins and peptides, aptamers can easily be attached to surfaces. They can also be renatured to their proper, active shape after nonhydrolytic denaturation.²⁶

Aptamers have been reported to detect targets at concentrations as low as 20 femtomoles in a sample of blood containing large numbers of complex proteins, carbohydrates, lipids, and whole cells.²⁷ Although this is a low detection limit, the committee estimates that the system-level detection limit and time constraints for detect-to-warn applications will require a detection limit on the order of only 300 organisms per 50 microliter sample volume, which corresponds to a target concentration of only tens of attomoles per liter (see Box 7.2). If 1,000 binding targets are expected per organism, and these binding sites can each be detected, then it is possible that a detection limit of 20 femtomoles will provide the sensitivity required for detect-to-warn applications. Aptamer-based sensor systems will need to be tested for actual biothreat detection to determine the detection limits for agents of interest.

Aptamer-target binding can be rapid, on a time scale that is likely faster than that for antibody systems because of the smaller mass of the aptamer. As with antigen-antibody systems, the rate of detection depends upon the concentration of the target, mass transfer of the target to the sensor surface, and the number of processing steps required for detection. Aptamer binding to targets, while normally noncovalent (as is antibody-target binding), can be designed to be covalent and thus more resistant to the harsh washes that are advantageous in minimizing nonspecific binding events. This has been demonstrated by substituting bromodeoxyuridine for uridine in the aptamer sequence.²⁸ Ultraviolet irradiation after target binding creates bromodeoxyuridine-free radicals, which covalently bind with electron-rich tyrosines in the protein target. After binding and washing, the proteins are chemically labeled with dyes for optical detection. While this approach should be useful for decreasing the number of false positives, there are remaining challenges, including detection within 1 to 2 minutes (since there are several processing steps) and developing methods for renewing the sensor surface to allow continuous monitoring.

Peptides

Antibodies are large proteins that bind the target molecules, but only a small fraction of their surface is dedicated to the binding site. This is the case with most proteins that bind small molecules, although it is also true that the binding site is formed by amino acids from the full length of the protein chain. Efforts have been successful in cutting antibody molecules into smaller pieces and isolating and using only the so-called variable regions that are involved in binding. Alternatively, bottom-up approaches involve the design, synthesis, and study of short peptides, looking for those that are long enough to fold and create a specific binding site.

One such approach involves the use of bacteriophage libraries. Through the use of combinatorial synthesis techniques, unique DNA base sequences, each coding for a different 7 to 12 amino acid peptide, can be incorporated into the pIII tail fiber gene of up to 10^9 to 10^{11} bacteriophage M13.²⁹ As a result, the peptide sequences to be screened are displayed on the tail fibers of these bacterial viruses. This phage library is then mixed with target—for example, spores from *Bacillus anthracis*. The phage that do not bind the target are washed away. Those that do bind the target are analyzed to determine the amino acid sequence of the peptides that can bind the target. Similar libraries have also been expressed on the surface of other organisms such as yeast.³⁰

²⁶ Gold, 2002. See note 25 above.

²⁷ Gold, 2002. See note 25 above.

²⁸ H. Petach and L. Gold. 2002. Dimensionality is the issue: Use of photoaptamers in protein microarrays. *Curr. Opin. Biotechnol.* 13:309-314.

²⁹ R.H. Hoess. 2001. Protein design and phage display. *Chemical Reviews* 101:3205-3218.

³⁰ Y.A. Yeung and K.D. Wittrup. 2002. Quantitative screening of yeast surface-displayed polypeptide libraries by magnetic bead capture. *Biotechnology Progress* 18:212-220.

A seven amino acid peptide that binds tightly to *Bacillus anthracis* has been identified³¹ and shown to have excellent species specificity, not binding even to closely related *Bacillus* strains. The peptide has an *N*-terminal sequence of asparagine, histidine, phenylalanine, leucine, followed by a tripeptide of variable but high proline amino acid content. The peptide has been shown to bind to the SpsC protein of the spore.³² Similar library construction and selection techniques could be employed to identify short peptide molecular recognition elements for other targets or other surface features of *B. anthracis*.

Small Molecules

The ligand-receptor complex that functions in cellular signal transduction, enzyme catalysis, and other biological systems usually involves a small molecule in which interactions with a large protein or cell surface feature. Specific synthetic small molecules have been designed for years to bind proteins and enzymes, inactivating them in drug discovery or disease therapy applications. It is clear, therefore, that the class of small-molecule molecular recognition elements can be explored in the search for high-affinity, high-specificity elements to bind large molecules or surface features on target organisms. This is being accomplished most effectively through the use of combinatorial libraries, with appropriate selection techniques, as pioneered by several groups.³³ Positional scanning libraries of millions of substrates, combined with high-throughput, fluorescence-based assays³⁴ are now widely applied by pharmaceutical companies in drug discovery. Synthesis can be performed on solid supports or by automated methods.³⁵ Small-molecule prospecting libraries cover substantial diversity space and are developed through novel synthetic methods for the rapid generation of scaffolds from which diverse functionality can be displayed.³⁶

Protein Receptors and Other Cell Surface Features

Vertebrates can detect (smell) a wide variety of odors at very low levels and distinguish among many that are very similar. This is achieved via cell surface structure-based sensors—receptors embedded in the cell membrane that bind an odorant molecule and signal the brain for identification and quantitation. In most cases, a given odorant excites a set of receptors, and identification is achieved through the ability of the brain to associate a particular pattern of receptors activated and the extent to which each is activated with the particular target odorant. Fish, for example, have been shown to respond to the presence of certain chemicals at picomolar concentrations,³⁷ and a fish odorant receptor has been isolated and shown to be specific for basic amino acids.³⁸

³¹ C. Turnbough, University of Alabama. Presentation to the committee on June 13, 2002.

³² C. Turnbough, 2002. See note 31 above.

³³ Houdebine, 2002. See note 16 above.

G. Liu and J.A. Ellman. 1995. Combinatorial asymmetric catalyst development: General solid phase synthesis strategy for the preparation of 2-pyrrolidinemethanol ligands. *J. Org. Chem.* 60:7712-7713.

³⁴ J.L. Harris, B.J. Backes, F. Leonetti, S. Mahrus, J. Ellman, and C. Craik. 2000. Rapid and general profiling of protease specificity by using combinatorial fluorogenic substrate libraries. *Proc. Natl. Acad. Sci.* 97:7754-7759.

D.J. Maly, L. Huang, and J.A. Ellman. 2002. Combinatorial strategies for targeting protein families: Application to the proteases. *ChemBioChem* 3:17-37.

³⁵ M.R. Spaller, M.T. Burger, M. Fardis, and P.A. Bartlett. 1997. Synthetic strategies in combinatorial chemistry. *Current Opinion in Chemical Biology* 1:47-53.

Houdebine, 2002. See note 16 above.

³⁶ Spaller et al., 1997. See note 35 above.

P.A. Bartlett and G.F. Joyce. 1999. Combinatorial chemistry: The search continues—editorial overview. *Current Opinion in Chemical Biology* 3:253-255.

M.R. Spaller, W.T. Thielemann, P.E. Brennan, and P.A. Bartlett. 2002. Combinatorial synthetic design. Solution and polymer-supported synthesis of heterocycles via intermolecular Aza-Diels-Alder and iminoalcohol cyclizations. *J. Comb. Chem.* 4:516-522.

³⁷ A.L. Barth, N.J. Justice, and J. Ngai. 1996. Asynchronous onset of odorant receptor expression in the developing zebrafish olfactory system. *Neuron* 16:23.

³⁸ D.J. Specca, D.M. Lin, P.W. Sorenson, E.Y. Isacoff, J. Nagai, and A.H. Dittman. 1999. Functional identification of a goldfish odorant receptor. *Neuron* 23:487-498.

Other naturally occurring cell surface features—e.g., glycoproteins, glycolipids, and proteoglycans found embedded in membranes—serve as binding sites for a variety of molecules, many of which are potential biological agents. Cholera and botulinum toxin, for example, attack cells by first binding to membrane gangliosides. These glycolipids, with a specific sequence and arrangement of sugars, extend from the membrane surface and exhibit a high degree of specificity toward their targets. Viruses also are known to bind to cell surface receptors. These various cell surface receptors could thus be used, perhaps in an engineered form, as molecular recognition elements for their natural pathogenic targets. In general, knowledge of the mechanism of action of pathogenic agents can lead to the identification of their cell surface targets and their development as molecular recognition elements.

Imprinted Polymers

Polymerization of certain monomers in the presence of target structures has been shown to create binding sites in the polymer that are specific for that target. High degrees of specificity have been reported for some small molecules,³⁹ although it could be argued that the sophisticated electronic, polar, and nonpolar interactions that normally increase binding constants in molecular recognition systems are likely to be lacking. While imprinted polymers developed to date are known to suffer from severe nonspecific binding problems, they do have increased stability over time and may therefore prove useful in the future as a molecular recognition material. Imprinted polymers are under development for the detection of whole cells,⁴⁰ but there is not yet convincing evidence that this approach is sensitive or selective enough for pathogen detection applications.

DETAILED CONSIDERATIONS: NOTIONAL DETECTION SYSTEMS

Once the target has bound to the molecular recognition element, that binding must be detected and quantified. A complete review of all potential transduction methods and sensor systems is beyond the scope of this report. Below are some representative structure-based biosensor systems that have been investigated for biothreat detection. Also included within each example are discussions about the current limitations of each of these systems or approaches for detect-to-warn applications.

Immunoassay Tickets

The most common structure-based sensors are immunoassay tickets. Several different types are under development and commercially available for the detection of a wide range of bacterial agents and toxins. These handheld, disposable sensors are analogous to widely used pregnancy test kits and are easy to use. A liquid sample is manually added to the test strip (ticket), and other reagents are added as required. As target molecules in the sample wick through the ticket, they bind to immobilized antibodies and detection molecules in a "sandwich" format. The appearance of a colored pattern on the ticket indicates a positive result. Some examples include the handheld immunochromatographic assays (HHAs), BTATM Test Strips, and the sensitive membrane antigen rapid test (SMART) system.⁴¹

While these devices are easy to use, they are disposable and the cost per assay is on the order of \$1 or more, making them unsuitable for continuous monitoring. Even if the disposables are minimized and these systems are reconfigured into an automated format for aerosol monitoring, the detection limit for these systems is currently too high for detect-to-warn applications. At least 10,000 targets bound to the sensor surface are required for detection, and the analysis time is 15 minutes or longer. As summarized in Box 7.1, even for a best-case notional detection system with this detection limit, more than 6 minutes will be required to collect enough sample to enable binding of 10,000 targets to a sensing surface. If a

³⁹ K. Haupt and K. Mosbach. 2000. Molecularly imprinted polymers and their use in biomimetic sensors. *Chemical Reviews* 100:2495-2504.

⁴⁰ Dickert and Hayden, 2002. See note 14 above.

⁴¹ A.A. Fatah, J.A. Barrett, and T.F. Moshier. 2001. Introduction to Biological Agent Detection Equipment for Emergency First Responders, NIJ Guide 101-00. Rockville, Md.: National Institute of Justice.

lysis step can be designed to release 100 targets per bioagent, then this detection limit might be suitable. In many cases where multiple targets per bioagent are not available, more sensitive detection methods are needed for detect-to-warn applications. As shown in the notional example in Box 7.2, a structure-based sensor with a detection level of 100 cells bound to the sensor surface (or a target concentration of about 10 attomoles in 50 microliters of solution) is required for a detect-to-warn detection system with a response time of less than 2 minutes.

Direct Binding Assays

It is clear that when considering the rapid response requirement of less than 2 minutes for a detect-to-warn system, assays that minimize the number of binding and washing steps are desirable. Although discussion of the notional example in Box 7.2 indicates that multiple rapid binding steps could theoretically be conducted within a total analysis time of 2 minutes, a sensor system will require fewer reagents, have simpler fluidics, and have a shorter response time if only one direct binding step is used for detection. A variety of transduction methods have been proposed that require only a single binding event for detection. Below are several direct binding assays that have been investigated for biodetection and a discussion of further work that is needed to realize structure-based detect-to-warn sensor systems.

Surface Plasmon Resonance

Optical sensors based on changes in evanescent electromagnetic fields at the surface of a thin film of a noble metal such as gold or silver have been widely investigated for direct binding assays. In one configuration, the evanescent field is established by layering a low index of refraction coupling layer between a prism and a high index of refraction resonant layer. These sensors have been used to detect a variety of binding events including analyte-surface binding of small molecules, ligand receptor binding, protein adsorption, antibody-antigen reactions, and DNA and RNA hybridization.⁴² Surface Plasmon Resonance (SPR) instruments are typically used for measuring binding constants of analytes in known solutions and are commercially available from several vendors (e.g., BIAcore, Texas Instruments, and Spreeta).

Detection is based on SPR spectroscopy, which measures alterations in the optical evanescent waves that result from changes in the refractive index near a surface following a binding event at that surface. The change can be detected by a shift in the angle of incidence to maintain resonance, by a wavelength shift, or by imaging. One challenge in using this approach for biodetection is that any nonspecific binding will contribute to the refractive index near the surface and result in a background signal that will affect the detection limit and potentially result in false positives. Methods are therefore needed to minimize nonspecific binding, enhance the signal from only the analyte, or allow stringent washing to remove nonspecifically bound molecules (and nonspecifically bound analytes).

The approach is sensitive to refractive index changes near the sensor surface, with sensitivity as high as one part in 10^5 to 10^6 at the sensor surface, corresponding to a mass sensitivity of 10^{-12} grams per square millimeter.⁴³ If one considers the binding of protein targets (150,000 molecular weight) onto a 1 square millimeter sensor surface, this detection limit corresponds to the binding of more than 10^6 targets onto the sensor surface. This detection limit is about two orders magnitude higher than immunoassay

⁴² B. Persson, K. Stenhag, P. Nilsson, A. Larsson, M. Uhlen, and P. Nygren. 1997. Analysis of oligonucleotide probe affinities using surface plasmon resonance: A means for mutational scanning. *Anal. Biochem.* 246:34-44.
D.G. Myszka, M.D. Jonsen, and B.J. Graves. 1998. Equilibrium analysis of high affinity interactions using BIAcore. *Analytical Biochemistry* 265:326-330.
J.M. McDonnell. 2001. Surface plasmon resonance: Towards an understanding of the mechanisms of biological molecular recognition. *Current Opinion in Chemical Biology* 5:572-577.
M.J. Cannon, D.G. Myszka, J.D. Bagnato, D.H. Alpers, F.G. West, and C.B. Grissom. 2002. Equilibrium and kinetic analyses of the interactions between vitamin B-12 binding proteins and cobalamins by surface plasmon resonance. *Analytical Biochemistry* 305:1-9.

⁴³ A.R. Mendelsohn and R. Brent. 1999. Protein biochemistry: Protein interaction methods: Toward an endgame. *Science* 284:1948-1950.

tickets and the notional example considered in Box 7.1 and therefore is also not sensitive enough for detect-to-warn applications. While the binding of whole cells onto a sensor surface would result in a larger signal per binding event than the binding of single proteins⁴⁴ (because this technique is most sensitive to material within 50 nanometers of the surface), most of the volume of the cells would not be detected, and the signal enhancement due to whole cell binding rather than proteins would not provide the 10^4 improvement in sensitivity required to detect only 100 targets (see Box 7.2).

Response times for SPR sensors have been reported to be between 10^{-1} and 10^3 seconds for high concentration samples. Real-time sensing has, however, been reported to be severely mass-transport-limited because of slow diffusion rates, leading to response times on the order of 10^3 to 10^4 seconds for analytes at concentrations between 10^{-6} and 10^{-7} moles. If diffusion dominates mass transport, the time required for analyte surfaces to reach half saturation coverage scales as the inverse square of bulk concentration. Therefore, mass transport is even more challenging for detect-to-warn applications, which require extremely low detection levels (estimated to be about 10×10^{-18} moles, see Box 7.2). Rapid, sensitive detection will require the development of sensor systems that include methods for minimizing mass transport times.

In addition to the need for enhanced mass transport approaches, the sensitivity of current SPR systems must be improved for detect-to-warn applications. Modifications of SPR systems are under development to increase sensitivity; there are signs that the extremely low detection limits required for detect-to-warn applications might be achievable in the future. Lithographically patterned, nanometer-size triangular silver particles (100 nanometers wide, 50 nanometers high) on a surface exhibit extremely large molar extinction coefficients (3×10^{11} per mole per centimeter), and the localized surface plasmon resonance (LSPR) spectrum is sensitive to nanoparticle-size shape and local (<30 nanometers) external dielectric environment.⁴⁵ In a model system, biotin was attached to the nanotriangles and exposed to 100 nanomolar streptavidin solution. A 27-nanometer red shift in peak extinction wavelength was observed. The limit of detection was reported to be in the low picomolar to high femtomolar range. While this is still not sensitive enough for detect-to-warn applications (a detection limit of about 10 attomoles is required), the committee projects that optimization will lead to detection of a few molecules in times on the order of seconds. The instrument is simple, small, light, robust, and low cost, so if the performance expectations are realized, this approach has potential for detect-to-warn applications.

Flow Cytometry

Cell biologists have for many years used flow cytometers—devices that identify, count, and sort cells on the basis of preselected properties.⁴⁶ In a sensor application, target cells are provided with fluorescently labeled molecular recognition elements (e.g., antibodies), and a stream of individual cells is passed through the detector for analysis.⁴⁷ Since flow cytometry analyzes single cells, the detection of 300 cells per 50 microliters, as described in the notional example in Box 7.2, is routinely achieved using this approach. The time required to analyze a sample volume of 50 microliters using a standard benchtop flow cytometer is between 10 and 60 seconds. Therefore, if specific labeling of the cells can be achieved in about 1 minute or less, then a total analysis time of less than 2 minutes is possible using flow cytometry (this conclusion assumes an aerosol collection time of 4 seconds and sample volume as described in Box 7.2). Direct detection of toxins or viruses is more challenging, since they are often too small for direct analysis using standard flow cytometers and the required reagents for each analysis. One approach for

⁴⁴ P.M. Fratamico, T.P. Strobaugh, M.B. Medina, and A.G. Gehring. 1998. Detection of *Escherichia coli* O157: H7 using a surface plasmon resonance biosensor. *Biotechnol. Tech.* 12:571-576.

⁴⁵ A.J. Haes and R.P. Van Duyne. 2002. A nanoscale optical biosensor: Sensitivity and selectivity of an approach based on the localized surface plasmon resonance spectroscopy of triangular silver nanoparticles. *J. Am. Chem. Soc.* 124:10596-10604.

⁴⁶ T.G.S. Kicker. 1999. Clinical analyzers: Advances in automated cell counting. *Anal. Chem.* 71:363R-365R.

⁴⁷ T. Krupa. 2002. Optical technologies in the fight against bioterrorism. *Optics and Photonics News*. February 23.
S.A. Sincock, H. Kulaga, M. Cain, P. Anderson, and P.J. Stopa. 1999. Applications of flow cytometry for the detection and characterization of biological aerosols. *Field Analytical Chemistry and Technology* 3:291-306.

the detection of these targets, which will be discussed below, is to bind them to microbeads and then analyze the microbeads using flow cytometry.

One advantage of a flow cytometry detection approach is that the analysis is done in solution, and it does not include a fixed sensor surface, which has a limited lifetime due to fouling and degradation. Disadvantages of flow cytometers for detection, however, are their large size, complexity, and high cost. Commercially available flow cytometers are benchtop systems that currently cost more than \$30,000 per system, although portable, miniaturized microfluidic flow cytometry systems (e.g., those available at <http://www.micronics.net>) are being developed. While this research has resulted in some miniature flow cytometry system components,⁴⁸ completely autonomous systems that are suitable for unattended monitoring are not currently available. When they are, they will be inherently complex, with many required fluidic manipulations and lasers that must be precisely aligned to optically interrogate single particles or cells one at a time. In the near term, flow cytometry is therefore well-suited for detection at centralized locations, but not for distributed use in many locations.

Multiplexed detection based upon direct flow cytometry of cells can potentially be achieved by monitoring variations in the individual properties of cells such as the optical scattering properties, electrical impedance, and fluorescence due to specific labeling with fluorescent dyes. The use of multiple dyes to enable the detection of multiple bioagents in a mixture complicates the optical detection system requirements (e.g., numbers and types of light sources and detectors needed). Therefore, new methods that enable multiplexed biothreat detection using flow cytometry concepts within simple microfluidic systems may be useful for detect-to-warn applications. Flow cytometry concepts of the future may be very different from current flow cytometers and may include transduction methods that are amenable to miniaturization and multiplexed analysis (see Table 7.1).

In addition to the detection of directly labeled cells, flow cytometry has been demonstrated for the multiplexed detection of biothreats using sandwich assays on color-coded beads. In this approach, microspheres carrying antibodies that bind bioagent targets are mixed with a target-containing sample and a second, fluorescently labeled antibody that also binds to the target. The optical properties of the beads themselves are used to code for up to 100 different antibody surfaces for binding specific bioagents. When bioagents and fluorescent dye molecules bind to a bead, it lights up and is measured by the flow cytometer. The flow cytometer is also used to measure the bead color and thereby identify the bioagent. This bead suspension array analysis is therefore analogous to a planar microarray, except that the specific binding elements are monitored by bead type rather than spatial location on a microarray. Benchtop bead suspension array systems are commercially available (e.g., Luminex Corp., Austin, Texas), and a Luminex LX-100 bead suspension array system has been incorporated into a fairly large but field-portable autonomous pathogen detection system (APDS) for deployment at locations where the public is at high risk⁴⁹ in order to provide detect-to-treat information. Methods are also under development for enabling unattended operation of bead-based assays using flow cytometers.⁵⁰

Bead suspension arrays were recently demonstrated for the simultaneous detection of four different bioagent simulants.⁵¹ The detection limits obtained with a total analysis time of about 1 hour (starting with a liquid sample) were about 5×10^4 cfu per milliliter for *Erwinia herbicola*, 1.5×10^4 cfu per milliliter for *Bacillus globigii*, 4.2×10^7 cfu per milliliter for MS2 (an RNA bacteriophage that is a simulant for smallpox virus), and 1 nanogram per milliliter (about 10^9 targets per milliliter) for ovalbumin (a protein that is a

⁴⁸ D.P. Schrum, C.T. Culbertson, S.C. Jacobson, and J.M. Ramsey. 1999. Microchip flow cytometry using electrokinetic focusing. *Anal. Chem.* 71:4173-4177.

M.A. McClain, C.T. Culbertson, S.C. Jacobson, and J.M. Ramsey. 2001. Flow cytometry of *Escherichia coli* in microfluidic devices. *Anal. Chem.* 73:5334-5338.

⁴⁹ M.T. McBride, S. Gammon, M. Pitesky, T.W. O'Brien, T. Smith, J. Aldrich, R.G. Langlois, B. Colston, and K.S. Venkateswaran. 2003. Multiplexed liquid arrays for simultaneous detection of simulants of biological warfare agents. *Anal. Chem.* 75:1924-1930.

⁵⁰ J.W. Grate, C.J. Bruckner-Lea, A. Jarrell, and D. Chandler. 2003. Automated sample preparation methods for suspension arrays using renewable surface separations with multiplexed flow cytometry fluorescence detection. *Analytica Chimica Acta* 478(1):85-98.

⁵¹ McBride et al., 2003. See note 49 above.

simulant for protein toxins). In all cases, a 100 microliter sample was used for each analysis. These detection limits were comparable to the gold standard enzyme-linked immunoassays (ELISA) that were conducted in parallel. Shorter analysis times of 30 minutes were reported to provide reasonable results, but they compromised the detection limit.

The number of cells required for each analysis above at a detection limit of 1,000 to 5,000 cfu in 100 microliters is about 10-fold higher than the number of cells considered in the notional example in Box 7.2. However, a 10-fold increase in aerosol sampling time could be used to increase the number of organisms collected, which would therefore increase the aerosol collection time from 4 seconds to 40 seconds in that example and still leave some time for analysis within the 2-minute time frame. Therefore, the detection limits for cells or spores using current bead suspension array systems appear to be compatible with detect-to-warn applications, and the detection limit for the toxin stimulant, 1 nanogram per milliliter, is comparable to a lethal dose for many toxins. However, the detection limit for the virus simulant is several orders of magnitude higher than needed for detect-to-warn applications (see Box 7.2), and in all cases the total analysis time to achieve the reported detection limits was about 1 hour. Therefore, novel approaches are needed to significantly decrease the time required for detection. Given that it is known that antibody-antigen binding kinetics are rapid when the binding partners are close to one another (see the section "Rapid Detection" in this chapter), methods that have the potential of decreasing the time for mass transport of the targets and detection tags to the bead or cell surfaces are needed.

Some challenges for detect-to-warn applications using flow cytometry are, therefore, (1) to dramatically decrease the time required for each of the binding and washing steps by enhancing mass transport to the cells or microspheres; (2) to decrease analysis time by minimizing the number of binding and washing steps; (3) to develop new flow cytometry-type approaches that are low cost (in terms of both instrumentation and consumables), amenable to miniaturization and field use, and suitable for multiplexed detection; and (4) to develop approaches to improve detection limits, especially for toxins and viruses.

Target Binding That Changes Detectable Properties of Smart Sensor Surfaces

Another general type of sensor system that is attractive for rapid detection, as required for detect-to-warn applications, is a sensor that is designed so that its surface changes in a detectable way only upon specific binding of the target to the sensor surface. This type of smart sensor surface could have advantages, including rapid one-step binding and detection, minimal false positives, sensitive detection if there is a built-in amplification scheme, and the potential for reversible (continuous) operation if the bound targets can be removed from the sensor.

Colorimetric Detection

One example of this general approach is the use of poly(diacetylene) liposomes that are engineered to contain bioagent binding sites⁵² for the colorimetric detection of bioagents. The liposomes are optically monitored in solution or after attachment to a planar surface. Binding of targets disrupts the membrane and causes a change in color from blue to red, which can be detected by eye or with a dedicated spectrometer. The device integrates over time, since each new binding event sequentially contributes to the color change. While this one-step approach is rapid (with a response time less than 2 minutes) and simple, the detection limit for cholera toxin was found to be 20 micrograms per milliliter (230 nanomoles). Dramatic improvements in detection limit are therefore required for detect-to-warn applications.

⁵² A. Reichert, J.O. Nagy, W. Spevak, and D. Charych. 1995. Polydiacetylene liposomes functionalized with sialic-acid bind and colorimetrically detect influenza virus. *Journal of the American Chemical Society* 117(2):829-830.
J.J. Pan and D. Charych. 1997. Molecular recognition and colorimetric detection of cholera toxin by polymerized liposomes. *Langmuir* 13:1365-1367.

Fluorescence Detection

Smart sensor surfaces that exhibit a fluorescence change upon specific binding of targets are also under development. For example, several groups are developing one-step detection approaches that involve fluorescently labeled aptamers that change conformation upon target binding. The sensing surface is engineered so that the conformational change in the aptamer results in a change in fluorescence intensity and/or fluorescence spectra of the sensor surface.⁵³ In one model biosensor system tested for thrombin detection, the detection limit was 5 nanomoles (0.7 attomole thrombin in 140 picoliters) and the analysis time was 10 minutes.⁵⁴ Given that single molecule fluorescence detection has been demonstrated in benchtop fluorescence detection systems with properly engineered smart sensor surfaces, it is conceivable that approaches based upon fluorescence detection will be able to detect 100 bound molecules (notional example in Box 7.2) in the near future.

One challenge is the development of fluorescent optical tags that are stable over time. Some promising optical tags include fluorescent nanocrystals (quantum dots) and green fluorescent protein, which includes a fluorosphere that is protected within the interior of a protein. Other challenges in fluorescence detection include the development of low-cost, portable optical detection systems and their components, including optical fibers and waveguides, and the development of engineered smart sensor surfaces that can reliably result in a measurable signal upon binding of fewer than 100 targets.

One-Step Signal Amplification Concepts

Smart sensor surfaces that include an engineered mechanism for one-step signal amplification would also be valuable to enable rapid, sensitive detection. For example, conducting polymers have been developed that carry multiple fluorescence groups, all of which can be quenched through the binding of a single triggering molecule.⁵⁵ This approach is reported to have the potential to amplify the detection signal up to a millionfold.⁵⁶ A biodetection amplification scheme based upon the conductance switching of ion channels upon target binding has also been demonstrated.⁵⁷

While the value of such engineered amplification schemes has been demonstrated, challenges remain, including the development of robust smart sensor surfaces that include engineered amplification schemes to enable sensitive, rapid biothreat detection.

-
- ⁵³ R.A. Potyrailo, R.C. Conrad, A.D. Ellington, and G.M. Heiftje. 1998. Adapting selected nucleic acid ligands (aptamers) to biosensors. *Anal. Chem.* 70:3419-3425.
 S. Jhaveri, M. Rajendran, and A.D. Ellington. 2000. In vitro selection of signaling aptamers. *Nature Biotechnology* 18:1293-1297.
 S.D. Jhaveri, R. Kirby, R. Conrad, E. Maglott, M. Boswer, R.T. Kennedy, G. Glick, and A.D. Ellington. 2000. Designed signaling aptamers that transduce molecular recognition to changes in fluorescence intensity. *J. Amer. Chem. Soc.* 122:2469-2473.
 C. Frauendorf and A. Jaschke. 2001. Detection of small organic analytes by fluorescing molecular switches. *Bioorg. Med. Chem.* 9:2521-2524.
 N.A. Hamaguchi, A. Ellington, and M. Stanton. 2001. Aptamer beacons for the direct detection of proteins. *Analytical Biochemistry* 294:126-131.
 J.W.J. Li, X.H. Fang, and W. Tan. 2002. Molecular aptamer beacons for real-time protein recognition. *Biochem. Biophys. Res. Commun.* 292:31-40.
 J. Perlette, J.W. Li, X.H. Fang, S. Schuster, J. Lou, and W.H. Tan. 2002. Novel DNA probes for detection and quantification of protein molecules. *Rev. Anal. Chem.* 21(1):1-14.
- ⁵⁴ Potyrailo et al., 2000. See note 53 above.
- ⁵⁵ L.H. Chen, D.W. McBranch, H.L. Wang, R. Hegelson, F. Wudl, and D.G. Whitten. 1999. Highly sensitive biological and chemical sensors based on reversible fluorescence quenching in a conjugated polymer. *Proc. Natl. Acad. Sci.* 96:12287-12292.
 S.A. Kushon, K.D. Ley, K. Bradford, R.M. Jones, D. McBranch, and D. Whitten. 2002. Detection of DNA hybridization via fluorescent polymer superquenching. *Langmuir* 18:7245-7249.
- ⁵⁶ Chen et al., 1999. See note 55 above.
- ⁵⁷ B.A. Cornell, V.L.B. Braach-Maksvytis, L.G. King, P.D.J. Osman, B. Raguse, L. Wiczorek, and R.J. Pace. 1997. A biosensor that uses ion-channel switches. *Nature* 387:580-583.

Modified Cell-Based Systems

Modified cell-based systems that include direct binding assays are also under development. One advantage of cell-based systems is that they can already contain a built-in signal amplification system. One example is the cellular analysis and notification of antigen risks and yields (CANARY) B cell detector.⁵⁸ B cells are components of the vertebrate immune system that display antibodies on their surface against virtually any foreign structure previously encountered by the organism. These cells can be cloned and engineered so that an entire population expresses a single antibody that is specific for the target of interest. Target binding of the surface antibodies is thought to lead to dimerization of the antibodies, which results in the release of Ca^{++} ions. In the CANARY sensor, B cells are engineered to express antibodies against a defined target and also the luminescent protein aequorin from the jellyfish *Aequorea victoria*. Aequorin responds to the Ca^{++} released upon target binding by emitting blue-green light. The cell response therefore both transduces and amplifies the molecular recognition event.

This relatively complex transduction method is quite rapid: The engineered B cells emit more than 2,000 photons within 30 seconds after bioagent binding.⁵⁹ For the purpose of biosensing, mixtures of the B cells are briefly centrifuged with samples in order to rapidly bring the target and sensor surface in close proximity to one another for binding. Detection limits are on the order of 50 target cells.

The CANARY system has been successfully tested using dry aerosol collection, in which aerosol is directly impacted into a small sample tube. After aerosol collection, the B cell solution is added, the sample is centrifuged (5 seconds), and the optical response is detected (30 seconds). One advantage of this approach is that it is a one-step method, with no additional washing or reagent addition steps. Given the low detection limit and rapid response of this approach, detection of 10 to 100 ACPLAs should be achievable in seconds (see notional example in Box 7.2), and a total analysis time within 2 minutes for detect-to-warn applications should be possible. Some testing with aerosol backgrounds has been done, and no detrimental effect on the optical signal was seen in samples containing 500 cfu *Y. pestis*, with and without the addition of an aerosol sample from a parking garage.

The system could also be multiplexed to detect a number of targets. B cell lines are now available for the detection of *Bacillus anthracis*, and orthopox viruses including smallpox, *Yersinia pestis* (plague), *Francisella tularensis* (tularemia), *Vibrio cholerae* (cholera), *Brucella* spp. (brucellosis), the foot and mouth disease virus, and the Venezuelan equine encephalitis virus. Others are in development. While this approach works well for the detection of cells and large viruses, the detection of small viruses is less sensitive because they do not sediment during standard centrifugation. Toxin detection using this approach is conceptually possible but has not been demonstrated yet (at least two binding sites on the target are required for the dimerization process to occur on the surface of the B cells).

One challenge that will arise in implementing a continuous detect-to-warn system is the incidence of false positives. The CANARY system is reported to have a low false positive rate of 0.4 percent over 1,288 laboratory tests and similar false positive rates of 0.3 percent to 0.6 percent for tests using actual indoor and outdoor aerosols (determined from more than 300 samples in each case).⁶⁰ Although these rates are low, if samples are analyzed every 2 minutes, this will result in false positives on average every 250 samples (0.4 percent), or 500 minutes (8.3 hours). The occurrence of successive positive samples may be one way to increase confidence that an actual positive has occurred, but this will decrease response time to the time required for the analysis of several samples in sequence. The sources and mechanisms of the false positives are not well understood. For detect-to-warn applications that require near-continuous monitoring, research is therefore needed to develop approaches to minimize false positives, by both improving individual detection systems and combining information from orthogonal sensors.

⁵⁸ J.D. Harper, MIT Lincoln Laboratory. Presentation to the committee on June 13, 2002.

⁵⁹ Harper. See note 58 above.

⁶⁰ Harper. See note 58 above.

A portable CANARY system that includes integrated aerosol collection and detection is being assembled, with a goal of detecting 100 ACPLA in 1.7 minutes. Some practical challenges of this type of approach are: The need to maintain live cells, the cost of each assay, and the disposables that will be generated for each assay. The cells survive 2 to 3 weeks when refrigerated,⁶¹ but extended use in the field will require the development of methods for long-term storage and maintenance of the cells. The cost of this analysis is estimated to be 25 cents per assay.⁶² Although this is considered to be inexpensive for a liquid-based biodetection assay, continuous monitoring every 2 minutes would result in a system operation cost of \$180 per day (\$65,700 per year).

The cost of biodetection assays in general is a significant consideration for continuous monitoring in detect-to-warn situations. Another practical issue is the potential accumulation of disposables during continuous operation. If one disposable sample tube is used per analysis, the system would result in the accumulation of 720 tubes each day and 262,800 tubes per year. This highlights another general challenge for all detect-to-warn systems that include liquid-based analysis: Novel chemistry and engineering solutions will be required to dramatically decrease disposables.

Waveguides and Fluorescent Detection

Many bioagent detection systems under development include the use of optical waveguides for collecting light from fluorescent molecular recognition element reporter groups. An optical waveguide system in a planar microarray format has recently been demonstrated for the simultaneous detection of multiple bacterial, viral, and protein analytes.⁶³ The detection limit of this system, developed at the Naval Research Laboratory, is similar to that of ELISA assays (e.g., 6×10^4 cfu per milliliter for *Bacillus globigii* and 1 to 10 nanograms per milliliter for various protein toxins).⁶⁴ The sample volumes analyzed are typically about 600 microliters, and the shortest reported analysis time is 15 minutes. The analysis was done using a sandwich assay that includes the following steps: sample (antigen) binding, washing, binding of fluorescently labeled secondary antibody, and washing.

Although an order of magnitude improvement in the detection limit for cells would be desirable for detect-to-warn applications, the 1×10^4 to 10×10^4 cfu per milliliter detection limits currently achieved using this approach may be suitable if aerosol collection times are approximately 1 minute (rather than 4 seconds, as listed in the notional example in Box 7.2) and the liquid volumes are scaled up to handle the quantities required for the assay. The major shortfall of this approach for detect-to-warn applications, however, is the analysis time, which is 10^{15} minutes in the best case. Therefore, all of the methods previously discussed to decrease analysis time (i.e., decrease volumes and dimensions, add active mass transport methods, develop one-step assay formats) are needed here. In addition, continuous monitoring will present engineering and chemistry challenges with regard to the need for the repeated renewal and reuse of the sensor, the accumulation of disposables, and the cost per assay.

Alternative approaches to two-step sandwich assays are one-step displacement assays or one-step competitive binding assays. For small molecules, the measured detection limits for sandwich, displacement, and competitive assays are typically different but still similar to one another in magnitude (e.g., ranging from 5 to 20 nanograms per milliliter).⁶⁵ However, for the detection of biothreats such as cells or spores, a sandwich assay can be at least one or two orders of magnitude more sensitive than the

⁶¹ Harper. See note 58 above.

⁶² Harper. See note 58 above.

⁶³ J.B. Delehanty and F.S. Ligler. 2002. A microarray immunoassay for simultaneous detection of proteins and bacteria. *Anal. Chem.* 74:5681-5687.

K.E. Sapsford, P.T. Charles, C.H. Patterson Jr., and F.S. Ligler. 2002. Demonstrations of four immunoassay formats using the array biosensor. *Anal. Chem.* 74: 1061-1068.

C.R. Taitt, G.P. Anderson, B.M. Lingerfelt, M.J. Feldstein, and F.S. Ligler. 2002. Nine-analyte detection using an array-based biosensor. *Anal. Chem.* 74: 6114-6120.

⁶⁴ Delehanty and Ligler, 2002. See note 63 above.

⁶⁵ Sapsford, 2002. See note 63 above.

other approaches if multiple-labeled secondary antibodies can bind to the target. Therefore, new one-step binding approaches that enable sensitive detection are needed for rapid biodetection.

One recently reported improvement in the detection limit of fluorescent waveguide sensors is the use of a capillary waveguide in which the sample solution itself is the waveguide. In this case the fluorescence signal is integrated over a larger surface area without increasing the background noise. Initial experiments indicate that this capillary waveguide format (used in combination with a sandwich assay) can improve the detection limit by about two orders of magnitude over the planar waveguide format.⁶⁶ The logistics of using and reusing a capillary for continuous operation in a biothreat detection system, however, may be a challenge when compared with other sensor system formats.

FINDINGS AND RECOMMENDATIONS

Finding 7-1: Theoretical considerations and experimental results support the view that structure-based sensors can be designed to respond within the 2-minute time period that is of interest for this study. The challenges for rapid detection for such detect-to-warn applications include accelerating the transport of the target to the molecular recognition element, decreasing the number of processing steps to speed detection, and improving detection sensitivity (detection of as few as 100 targets bound to the sensor surface is needed).

Recommendation 7-1: Conduct research on practical ways of accelerating mass transport to the molecular recognition sites and developing sensing platforms that reduce the number of processing steps. Conduct research on approaches to enable the required level of detection for detect-to-warn applications.

Finding 7-2: Impressive progress has been made in designing and synthesizing molecular recognition elements. A variety of classes of these molecules has been identified, many of which exhibit attractive properties, including ease of synthesis, specificity, stability, and affinity. However, few have been tested under real-world environmental operating conditions, and false positive rates must be minimized for detect-to-warn applications.

Recommendation 7-2: Research across a broad front of molecular recognition elements should be pursued. The focus of research should be on development of a greater understanding of the structural and binding characteristics of these materials and of practical ways to reduce the false positive rates for these sensors and on testing the sensor performance (sensitivity, selectivity, and false alarm rate) under the anticipated environmental operating conditions (with appropriate background organisms and aerosols).

Finding 7-3: Impressive progress has been made in the development of reporter tags and instrumentation capable of detecting them.

Recommendation 7-3: Research across a broad front of reporter tags and detection schemes should be pursued. The focus should be on simplicity of the system (absence of a wash step, for example) and simplicity of instrumentation to allow wide distribution of these systems for detect-to-warn applications.

⁶⁶ F.S. Ligler, M. Breimer, J.P. Golden, D.A. Nivens, J.P. Dodson, T.M. Green, D.P. Haders, and O.A. Sadik. 2002. Integrating waveguide biosensor. *Anal. Chem.* 74:713-719.

Finding 7-4: Research described above is being pursued in a very large number of university, government, and industrial laboratories. Unfortunately, it is often difficult to compare results and to evaluate progress because a variety of measurement units are used to report (or not report) results.

Recommendation 7-4: A standardized reporting scheme for sensor description needs to be developed. It should be based on performance requirements such as affinity, specificity, speed, false positive rate, cost, manufacturability, and other criteria.

8

Chemistry-Based Identification for Detect-to-Warn Applications

The characterization technologies discussed in this chapter are those that respond to the chemical composition of the target molecules rather than to their three-dimensional structure or biological activity. The discussion covers several distinct classes of molecules present in biological agent cells, including the following:

- **Proteins.** Many studies have evaluated the feasibility of identifying microorganisms by detecting the proteins present within or on the surface of the organisms. Peptides¹ and combinations of peptides may be unique to certain classes of microorganisms and can also be detected.
- **Lipids.** The membranes that surround cells contain high concentrations of lipids, usually closely associated with proteins. The lipid and protein composition varies from one type of microorganism to another.
- **Carbohydrates.** Chains of differing carbohydrate molecules, termed polysaccharides, are also found on the surface of cells and may be used to identify distinct varieties of microorganisms.
- **Metabolites.** These smaller molecules serve as intermediates in metabolic pathways, energy sources, communicators within a cell and between cells, and regulators of activity, and are involved in many other crucial metabolic functions. Rapid sensing of metabolites could potentially be used to determine that a biological threat is present. Although metabolites are typically not unique to any specific type of cell and are therefore not useful for identifying a particular class of microorganism, one exceptional small metabolite—dipicolinic acid—is diagnostic of some spore-forming microorganisms such as *Bacillus anthracis*, the bacterium that causes anthrax.
- **Nucleic acids.** DNA is the blueprint for all biological activity within most organisms. The presence of DNA and/or RNA can be used to indicate the presence of biological versus nonbiological materials. One prevalent type of RNA, messenger RNA (mRNA), is used as a template for protein synthesis within cells. This type of RNA is rapidly synthesized and degraded within cells, with a turnover rate of only 2 or 3 minutes in microorganisms.² The presence of high levels of mRNA can therefore be used as an indicator of cell activity and viability. Dormant cells, such as spores, would not have high levels of mRNA but would still contain other types of nucleic acids such as ribosomal RNA (rRNA) and DNA.

¹ Small sections of proteins are called peptides.

² G.M. Cooper. 2000. *The Cell: A Molecular Approach*. Washington, D.C.: ASM Press.

Chemical methods of identifying these target molecules include techniques based on molecular mass, composition, functional groups, relative affinity for various surfaces, or other chemical properties. These methods may be complementary to alternative techniques for identifying the same classes of molecules discussed in other chapters (e.g., immunoassays for proteins, discussed in Chapter 7).

Several centuries of effort by many tens of thousands of chemists have gone into developing the equipment in a modern analytical chemistry laboratory. While the full complement of technologies could be useful for bioagent detection or identification, a review of the techniques most often used indicates that only two or three technologies stand out as the most promising candidates for routine rapid bioagent detection. They are discussed below.

MASS SPECTROMETRY

Perhaps the most fundamental characteristic of a chemical component is its intrinsic molecular weight or mass. Mass spectrometers characterize molecules by taking advantage of differences in their mass. A simple metabolite may have a mass of several hundred daltons, while some of the large proteins have a mass well over a million daltons. Mass spectrometers can be among the most complex instruments in a chemical laboratory, yet they are highly versatile and are heavily used for many chemical analyses. (See Box 8.1 for a brief primer on mass spectrometers.) Over the past decade, many investigators have explored the application of mass spectrometry to the identification of biothreat agents.

Among the most definitive molecular discriminators of potential biothreat agents are proteins and distinctive lipid, peptide, and polysaccharide components of bacterial membranes and cell walls. Of the several thousand different proteins in a typical bacterium, some may be unique to a particular strain or subspecies and would therefore have excellent potential for the identification of the strain. Other proteins may be common to multiple species of dangerous microorganisms and thus serve as useful flags for the presence of these organisms.

Because of their relatively high cost and complexity, mass spectrometers are better suited to the identification of biological agents rather than their detection. Several different approaches have been taken to the identification of proteins and other complex cell components by mass spectrometry. One, often termed "biomarker fingerprinting," involves generating a mass spectrum of a prepared sample and attempting to match it against a previously collected library of mass spectra of known organisms. This method is the one most often proposed for bioagent identification by mass spectrometry. In this approach, it is not necessary to know the identity or function of the proteins or other complex molecules that are responsible for the signal. Like a fingerprint, it is the pattern of signals that is identified and compared with a list of potential suspects.

Box 8.1 **Mass Spectrometry**

The separation of molecules based on their mass is, in principle at least, fairly straightforward. If each molecule in a mixture is given a push in the same direction, the lighter ones will move faster and the heavier ones slower, effecting a separation in space. Alternatively, a force can be applied to a mixture of moving molecules. The lighter ones will be more strongly affected by the force and the heavier ones less affected, due to their inertia, again resulting in a separation. Mass spectrometers of all varieties function on these simple principles and operate in a vacuum to avoid collisions of the target molecules with the nitrogen and oxygen molecules in air.

Mass spectrometers initially put an electric charge on the molecules to form ions. These ions can then be manipulated by an electric or magnetic field, providing the force needed to accelerate them and steer them into a desired path. In a time-of-flight (TOF) mass spectrometer, the same charge is put on all the molecules, and they are accelerated in a straight line so that they fly down an evacuated tube. By measuring how long they take to reach a detector at a fixed position, and taking into account the length of the flight tube and the charge on the ions, one can obtain a mass spectrum that plots the

variation in mass versus the number of ions detected at each mass.

Other varieties of mass spectrometers are frequently used in chemistry and physics laboratories. Some separate ions by injecting ions into a curved electric field. Varying the field in a well-defined way can force unwanted ions out of the pathway to a detector, effectively allowing the detection of only ions of a specific desired mass. Major classes of mass spectrometers that operate in this fashion are termed quadrupole mass spectrometers and ion-trap mass spectrometers.

Several varieties of hybrid mass spectrometers exist. One example is a combination of a quadrupole mass spectrometer with a time-of-flight spectrometer. One of the reasons for the popularity of these systems is that the first mass spectrometer can be used to select a small range of masses, rejecting the bulk of other masses that could interfere with subsequent detection. The selected ions are then separated with high resolution by the second mass spectrometer. These systems are also designed to break larger ions into smaller ones, thus providing information about the structure of the original molecule. This two-spectrometer technique is known as tandem mass spectrometry and also as MS/MS.

Any mass spectrometer requires a method of forming ions from the molecules in the sample. Two primary ionization methods are in common use for proteins and other large molecules that might be diagnostic of biothreat agents. One is termed matrix-assisted laser desorption and ionization, usually referred to as MALDI. In MALDI, the sample—perhaps a protein mixture in the case of biothreat agents—is mixed with a larger quantity of an organic molecule (the matrix). The matrix is selected for its ability to efficiently absorb radiation from a laser. When the dried sample-matrix mixture is exposed to a laser beam, the matrix absorbs the laser energy and transfers it to the sample, typically forming positive ions with a single charge. These charged molecules are separated and detected in a mass spectrometer. MALDI experiments most frequently use a TOF mass spectrometer in a system usually known as MALDI-TOF.

A second method of ionizing the sample is known as electrospray ionization. In this method, a liquid sample is continuously aerosolized into a fine spray near a needle maintained at high electrical potential. The droplets take on a charge from the electric field. As the charged droplets evaporate, the charge is transferred to proteins or other organic molecules in the sample, forming ions that can be separated by a mass spectrometer. Unlike MALDI, which produces mostly ions with a single charge, electrospray ionization results in ions with many charges on them. This characteristic has both advantages and disadvantages. One advantage is that mass spectrometers separate ions by their mass-to-charge ratio rather than by their mass only. This means that large, heavy, multiply-charged ions are detected at the same mass as small singly-charged ions. Many types of mass spectrometers are easier to design and build for these lower mass ions and have better sensitivities than they do for high-mass ions. The disadvantage is that a single parent molecule in an electrospray system may be present in many different charge states, resulting in a complex spectrum. While modern software is effective in dealing with this complexity and calculating the mass of the parent molecule, this is still a characteristic that one would rather not deal with for the rapid detection of bioagents, particularly in a complex environmental sample.

Electrospray applications to whole proteins derived from lysed cellular components have been limited. As a result, the vast majority of protein applications first use enzymes to break the protein down into small peptides, which are ionized efficiently. Liquid chromatography equipment is then used to remove compounds that might interfere in the analysis and to separate the resulting peptide mixture. These steps add time and complexity to the sample preparation and probably explain why electrospray ionization is rarely used for the mass spectrometry of biothreat microorganisms.

Well-organized tutorials on mass spectrometry can be found on the Web sites of the American Society of Mass Spectrometry^a and the British Mass Spectrometry Society.^b

^a Available online at <http://www.asms.org/whatisms/>. Accessed November 2003.

^b Available online at http://www.bmss.org.uk/what_is/whatisframeset.html. Accessed November 2003.

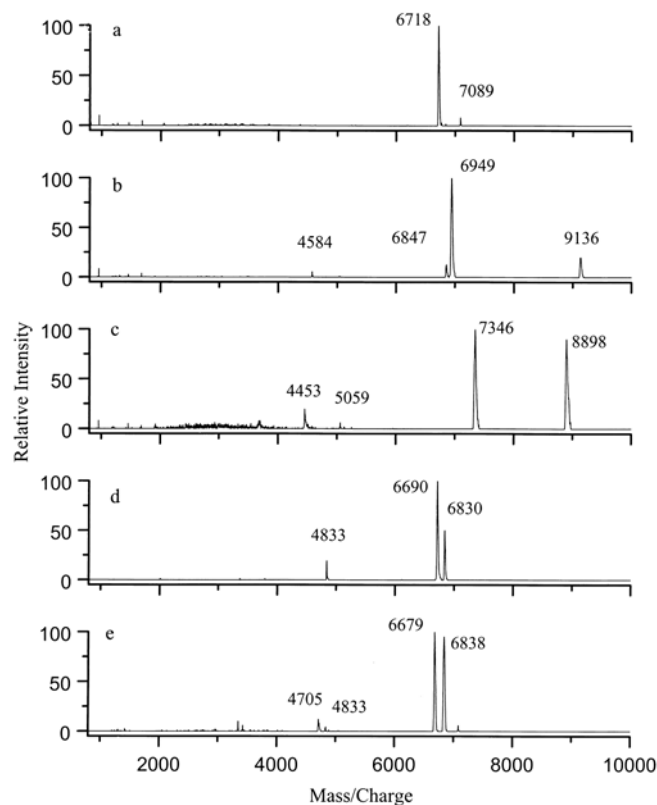

FIGURE 8.1 Comparison of mass spectra from various *Bacillus* species: (a) *B. thuringiensis*, (b) *B. subtilis*, (c) *B. globigii*, (d) *B. cereus*, and (e) *B. anthracis* Sterne.

Research into the mass spectrometric methods for the characterization of microorganisms is an active field today, with several reviews available.³ Figure 8.1 illustrates mass spectra of 5 different species of *Bacillus* bacteria. The first four species are not normally considered to be harmful, and the last is the *Bacillus anthracis* species responsible for anthrax. Note first that each mass spectrum is different. While the first four are very different from one another and might be expected to be easily differentiated, spectra (d) and (e) are similar but still different in detail. It is interesting that spectrum (d) is of *Bacillus cereus*, a bacterium that is known to be very similar to *Bacillus anthracis* from a microbiology standpoint but that does not have the lethal effects of *B. anthracis*. It should also be noted that no attempt was made to identify the molecular source of the signals in the mass spectra. With additional effort it is possible to identify many of the biomarker components,⁴ but this is not necessary for fingerprint matching.

Bacterial cells also contain characteristic lipids that vary in composition among species. These lipids may be rapidly converted to volatile forms that can be ionized for mass spectrometry characterization. This method has been shown to differentiate successfully among species and strains within species if pure bacterial samples are used.⁵ However, it is not likely to be selective enough to identify a hostile organism in a mixture with benign background organisms. This limitation probably precludes its use for rapid bioagent identification. For the biomarker fingerprinting approach, the mathematical procedures used to match the observed spectra with the library of candidate microorganism spectra are every bit as important as the mass spectrometry itself, and this is an area of active research.⁶

³ B.L.M. van Baar. 2000. Characterisation of bacteria by matrix-assisted laser desorption/ionization and electrospray mass spectrometry. *FEMS Microbiology Reviews* 24:193-219.

C. Fenselau and P.A. Demirev. 2001. Characterization of intact microorganisms by MALDI mass spectrometry. *Mass Spect. Rev.* 20:157-171

J.O. Lay. 2000. MALDI-TOF mass spectrometry and bacterial taxonomy. *Trends Anal. Chem.* 19:507-516.

⁴ R.D. Holland, C.R. Duffy, F. Rafii, J.B. Sutherland, T.M. Heinze, C.L. Holder, K.J. Voorhees, J.O. Lay. 1999. Identification of bacterial proteins observed in MALDI TOF mass spectra from whole cells. *Anal. Chem.* 71(15):3226-3230.

P.A. Demirev, J. Ramirez, and C. Fenselau. 2001. Tandem mass spectrometry of intact proteins from characterization of biomarkers from *Bacillus cereus* T spores. *Anal. Chem.* 73(23):5725-5731.

B. Amiri-Eliasi and C. Fenselau. 2001. Characterization of protein biomarkers desorbed by MALDI from whole fungal cells. *Anal. Chem.* 73(23):5228-5231.

⁵ F. Basile, M.B. Beverly, C. Abbas-Hawks, C.D. Mowry, and K.J. Voorhees. 1998. Direct mass spectrometric analysis of in situ thermally hydrolyzed and methylated lipids from whole bacterial cells. *Anal. Chem.* 70:1555-1562.

⁶ Fenselau and Demirev, 2001. See note 3 above.

P.A. Demirev, J.S. Lin, F.J. Pineda, and C. Fenselau. 2001. Bioinformatics and mass spectrometry for microorganism

A second approach to mass spectrometric identification is to target specific proteins known to be present in biothreat agents. A prime example might be the detection of botulinum toxin, a biothreat agent that can be released as a relatively pure protein rather than as an infectious organism.⁷ In this case the detector is focused on a specific molecule, and its detection is an immediate warning that the threat agent is present. The disadvantage of this approach is that the protein may be difficult to detect rapidly in the presence of other proteins that might be present in the environment. A variety of chemical purification methods are available for this circumstance, but using them increases detection time and instrumental complexity. These factors probably exclude this approach from consideration for rapid identification.

In matrix-assisted laser desorption and ionization time-of-flight (MALDI-TOF) mass spectrometry (see Box 8.1), one can optimize the system and procedures to partially classify whole proteins. Typically, only a few of the many proteins in a sample are detected. Alternatively, the microorganism can be exposed to an enzyme that cuts the proteins into smaller peptides in a somewhat reproducible and predictable manner. These peptides, usually in the mass range of 1,000 to 5,000 daltons, are often ionized and detected with MALDI. The pattern of detected masses is then used in a fingerprinting mode for identification of many of the proteins in the sample. A characteristic of this latter approach is that it requires multiple and sometimes complex sample preparation steps before a sample is suitable for analysis. The time required for an approach that includes a protein digestion step (typically more than 15 minutes) probably excludes it from use in detect-to-warn applications.

Early MALDI work with microorganisms involved isolation of a particular species from a carefully prepared bacterial culture, chemical breakdown of the cell membranes to expose the internal cell structures and molecules, and analysis of the resulting complex solution in the mass spectrometer. However, more recent work has shown that much of this effort can be avoided by directly analyzing the intact bacterial cells. The cells are mixed with the MALDI matrix, dried, and analyzed immediately without intervening complex chemical procedures.⁸

While the number of cellular constituents detected by this method may be small in comparison with the total number of molecules in the cell, the spectral fingerprints obtained have been demonstrated to be sufficient for the discrimination among similar bacterial and viral species and even among different strains of *Bacillus anthracis* spores⁹ as long as the target organism is analyzed in the absence of major concentrations of background organisms. Most of the current efforts in the use of mass spectrometry for bioagent detection are taking this approach.

The currently fielded chemical biological mass spectrometer (CBMS) Block III, a component of the Biological Integrated Detection System (BIDS), uses a fingerprint approach. Rather than characterizing intact organisms with MALDI, however, this system rapidly pyrolyzes (vaporizes with high temperature) cellular components from a collected aerosol, ionizes them with an electron impact device, and generates

identification: Proteome-wide post-translational modifications and database search algorithms for characterization on intact *H. pylori*. *Anal. Chem.* 73:4566-4573.

R.J. Arnold and J.P. Reilly. 1998. Fingerprint matching of *E. coli* strains with matrix-assisted laser desorption/ionization time-of-flight mass spectrometry of whole cells using a modified correlation approach. *Rapid Commun. Mass. Spectrom.* 12:630-636.

K.H. Jarman, S.T. Cebula, A.J. Saenz, C.E. Petersen, N.B. Valentine, M.T. Kingsley, and K.L. Wahl. 2000. An algorithm for automated bacterial identification using matrix-assisted laser desorption/ionization mass spectrometry. *Anal. Chem.* 72:1217-1223.

J.J. Bright, M.A. Claydon, M. Soufian, and D.B. Gordon. 2002. Rapid typing of bacteria using matrix-assisted laser desorption ionization time-of-flight mass spectrometry and pattern recognition software. *J. Microbiol. Meth.* 48:127-138.

⁷ W.A. Bryden, Johns Hopkins University. Presentation to the committee on September 25, 2002.

B.L. van Baar, A.G. Hulst, A.L. de Jong, and E.R. Wils. 2002. Characterisation of botulinum toxins type A and B, by matrix-assisted laser desorption ionisation and electrospray mass spectrometry. *J. Chromatogr. A* 970(1-2):95-115.

⁸ R.D. Holland, J.G. Wilkes, J.B. Sutherland, C.E. Persons, K.J. Voorhees, and J.O. Lay, Jr. 1996. Rapid identification of intact whole bacteria based on spectral patterns using MALDI-TOF-MS. *Rapid. Commun. Mass Spectrom.* 10:1227-1232.

M.A. Claydon, S.N. Davey, V. Edward-Jones, and D.B. Gordon. 1996. The rapid identification of intact microorganisms using mass spectrometry. *Nature Biotechnol.* 14:1584-1586.

T. Krishnamurthy, P.L. Ross, and U. Rajamani. 1996. Detection of pathogenic and nonpathogenic bacteria by matrix-assisted laser desorption/ionization time-of-flight mass spectrometry. *Rapid Commun. Mass Spectrom.* 10:883-888.

⁹ E. Elhanany, R. Barak, M. Fisher, D. Kobiler, and Z. Altboum. 2001. Detection of specific *Bacillus anthracis* spore biomarkers by matrix-assisted laser desorption/ionization time-of-flight mass spectrometry. *Rapid Commun. Mass Spectrom.* 15(22):2110-2116.

a mass spectral fingerprint in an ion trap mass spectrometer. While potentially a useful rapid screening tool for biological agents on the battlefield, it is unlikely that this system will have the specificity needed for the extremely low false alarm rates required of a rapid identifier in a detect-to-warn architecture. The pyrolysis fragmentation pattern is a function of many variables, and it has not been demonstrated that these signatures offer sufficient discrimination in a complex background to support a 10^{-6} false alarm rate.

Challenges for Rapid, Simple-to-Use Mass Spectrometry Identification Systems

MALDI-TOF mass spectrometers are used routinely in laboratories to identify proteins. It should be recognized, however, that these samples have been previously purified such that they contain only a few distinct proteins. Even with the very best-performing laboratory MALDI mass spectrometers, it is difficult to achieve identification of unknown proteins when more than a few proteins are present in the sample. Typical indoor aerosol samples could contain hundreds of different species of microorganisms (see Chapter 3), including both viable and nonviable bacteria, spores, algae, fungi, and viruses that are associated with particles in the 1- to 30-micrometer range. While at any one time only about 10 to 20 different species may be identifiable by techniques requiring cell culturing, many more species are expected to be present that are not culturable by standard microbiological methods. Mass spectrometry approaches could be used to detect the proteins of all organisms, both culturable and nonculturable. Preliminary investigations into identification of mixtures containing a few different well-known species show some progress,¹⁰ but the number of organisms used for these studies is very small in comparison with the number that may be found in real-world samples. The committee is aware of recent work by DARPA assessing the performance of MALDI for agent identification in samples containing significant concentrations of background organisms. Combined efforts are being applied in areas of sample preparation, the MALDI ionization procedures, and detection algorithms. Summary data are expected to be available by the time this report is published.

Several reviewers have noted that use of MALDI for microorganism identification is made more difficult by spectral complexities and by loss of signal if inorganic salts are present in the sample.¹¹ Many of the locations in which detect-to-warn identification systems might be deployed are in coastal areas likely to contain large concentrations of salts in the sampled aerosol. However, simple washing can be used to wash away most of the interfering salts and leave the organisms and proteins on the sample holder. Other sample preparation processes could also be implemented to remove salts.¹² For detect-to-warn applications, it would be necessary to develop methods for sample washing/processing that are extremely rapid (accomplished in seconds rather than minutes).

An additional challenge is the degree of reproducibility required for the fingerprints in order to achieve accurate identification. A pioneer in intact microorganism identification with MALDI reports that it is often difficult to obtain reproducible spectra, even from the same organism.¹³ Other investigators have reported that selected mass spectrometer signals can be identified that are reproducible in different laboratories.¹⁴ One assessment using a commercial microorganism MALDI detection system for pure

¹⁰ Jarman et al., 2000. See note 6 above.

K.L. Wahl, S.C. Wunschel, K.H. Jarman, N.B. Valentine, C.E. Petersen, M.T. Kingley, K.A. Zartalas, and A.J. Saenz. 2002. Analysis of microbial mixtures by matrix-assisted laser desorption/ionization time-of-flight mass spectrometry. *Anal. Chem.* 74:6191-6199.

¹¹ J.O. Lay. 2000. MALDI-TOF mass spectrometry and bacterial taxonomy. *Trends in Anal. Chem.* 19:507-516.

B.L.M. van Baar, TNO Prins Maurits Laboratory. Presentation to the committee on September 25, 2002.

¹² M. Kussman, E. Nordhoff, H. Rahbek-Nielsen, S. Haebel, M. Rossel-Larsen, L. Jokobsen, J. Gobom, E. Mirgorodskaya, A. Kroll-Kristensen, L. Palm, and P. Roepstorff. 1997. Matrix-assisted laser desorption/ionization mass spectrometry sample preparation techniques designed from various peptide and protein analytes. *J. Mass Spectrometry* 32:593-601.

¹³ J. Lay, 2000. See note 11 above.

¹⁴ Z. Wang, K. Dunlop, S.R. Long, and L. Li. 2002. Mass spectrometric methods for generation of protein mass database used for bacterial identification. *Anal. Chem.* 74:3174-3182.

microorganisms under tightly controlled conditions stated that MALDI could not properly identify a quarter of the samples separately identified by the gold-standard PCR sequence method.¹⁵

In comparing the direct MALDI analysis of intact microorganisms with more complex methods using MALDI or electrospray ionization mass spectrometry after a chemical separation, it has been found that the direct MALDI method is more prone to interference from other components in the sample and provides many fewer fingerprint components from which to identify the microorganism.¹⁶ However, progress has been made in using the MALDI mass spectrometer (MS) for the direct identification of bacterial species in mixtures of up to five organisms,¹⁷ and the differentiation between two strains of *Staphylococcus aureus* has also been demonstrated using MALDI-MS.¹⁸ In spite of this recent progress in developing MALDI-MS methods for bacterial identification, the characteristics and conditions that produce reproducible fingerprints from intact microorganisms using MALDI, the best procedures for matching the fingerprints with libraries of fingerprints of known organisms, and the level of bacterial identification (e.g., species, strain) that can be achieved in complex environmental samples are not well understood at the present time.

It has been suggested that since the individual biothreat agents in aerosols are separated into discrete particles that can be characterized individually, a system could be devised that first detects individual biological particles in a moving aerosol stream by optical methods¹⁹ and feeds only selected individual particles into the MALDI spectrometer. It is claimed that in this way, potential interference resulting from the presence of many different organisms in a sample for MALDI mass spectrometry may be avoided.²⁰ While this suggestion is indeed interesting, the committee is aware of only preliminary data indicating that this approach might be successful. A major challenge will be the sensitivity of detection. Laboratory-based MALDI-TOF systems typically require on the order of 10 to 100 separate detection events to achieve sufficient signal to allow molecule identification. The direct aerosol sampling approach would necessitate identification using only a single detection event. While this could potentially be a powerful tool to obtain near-instantaneous identification of organisms, further laboratory work is needed to determine if direct MALDI-MS analysis of individual aerosol particles is a viable approach for rapid pathogen identification.

An additional challenge for continuous-use detect-to-warn applications is the instrumentation complexity. While mass spectrometry is certainly one of the mainstays of today's chemistry and biotechnology laboratories, current laboratory MALDI-TOF mass spectrometers do not come in small easy-to-use packages. They typically are benchtop- or floor-mounted systems at least the size of several three-drawer file cabinets. The MALDI-TOF contains a significant amount of hardware: a moderate-power laser, an extensive vacuum system, multiple power supplies running high voltages, and very high speed electronics. With this mechanical and electronic complexity comes cost. A typical laboratory system having performance appropriate for peptide mass fingerprinting sells for around \$250,000, although several groups have reported results for intact protein application using more compact, less expensive systems.²¹ Modern MALDI-MS systems that are commercially available are very reliable but—as with any analytical instrumentation—they require a regular maintenance schedule for reliable operation.

¹⁵ Z. Du, R. Yang, Z. Guo, Y. Song, and J. Wang. 2002. Identification of *Staphylococcus* and determination of its methicillin resistance by matrix-assisted laser desorption/ionization time-of-flight mass spectrometry. *Anal. Chem.* 74:5487-5491.

¹⁶ Wang et al., 2002. See note 14 above.

¹⁷ Wahl et al., 2002. See note 10 above.

¹⁸ K. Bernardo, N. Pakulat, M. Macht, O. Krut, H. Seifert, S. Fleer, F. Hunger, and M. Kronke. 2002. Identification and discrimination of *Staphylococcus aureus* strains using matrix-assisted laser desorption/ionization-time of flight mass spectrometry. *Proteomics* 2:747-753.

¹⁹ M.A. Stowers, A.L. van Wuijckhuijse, J.C.M. Marijnissen, B. Scarlett, B.L.M. van Baar, and Ch.E. Keintz. 2000. Application of matrix-assisted laser desorption/ionization to on-line aerosol time-of-flight mass spectrometry. *Rapid Commun. Mass Spectrom.* 14:829-833.

²⁰ van Baar, 2002. See note 11 above.

²¹ See, for example, P.A. Demirev, Y.P. Ho, V. Ryzhov, and C. Fenselau. 1999. Microorganism identification by mass spectrometry and protein database searches. *Anal. Chem.* 71:2732-2738.

Of course, the challenge of reliable operation is much greater if the intended use of the mass spectrometer is for detect-to-warn applications that require constant operation in an unattended fashion. Achieving this level of reliability with the complexity of a mass spectrometer would require additional instrument engineering.

Active efforts are under way to scale down and simplify MALDI-TOF systems for bioagent detection applications.²² Efforts have also been directed toward miniaturizing the components of mass spectrometers.²³ However, the scaling laws for mass spectrometry dictate that there will be a reduction in performance as the spectrometer dimensions are reduced. Thus, levels of performance achieved in laboratory systems are not likely to be reproduced in these smaller packages. This is exemplified by the demonstration of a mass resolution of about 440 (mass/delta mass) at a mass of 1,675 daltons for a well-known miniaturized system.²⁴ This mass resolution is about 30 times poorer than that shown for a similar mass by a conventional laboratory MALDI mass spectrometer.²⁵ Poorer mass resolution means poorer accuracy in the identification of microorganisms by their biomarker fingerprint. While the development of compact mass spectrometers for bioagent detection could provide valuable insights into future directions, the committee believes that a higher priority for practical detect-to-warn scenarios would be to demonstrate that the best available laboratory equipment is capable of accurately identifying important bioagents in the presence of naturally occurring microorganisms found in real-world environments. Once the basic capability is established in the laboratory, it will be clearer what performance trade-offs might be acceptable in simpler, more compact systems.

GAS- AND LIQUID-PHASE SEPARATIONS FOR PATHOGEN DETECTION

While mass spectrometers are widely used in chemical laboratories, methods for separating molecules in flowing vapor or liquid streams are nearly ubiquitous. In these methods the sample streams flow through a column packed with material that interacts reversibly with molecules in the sample. The molecules that interact strongly with the packing move more slowly through the column than those that have weak interactions. This process, called chromatography, enables the separation of complex chemical mixtures. Both gas chromatography (separation of volatile molecules in the gas phase) and liquid chromatography (separation in the liquid phase) are used for a wide variety of chemicals and may be applied to some classes of bioagents. Electrophoresis, in which liquid-phase separations are driven by electric fields, is another frequently used method.

Protein toxins such as botulinum toxin or ricin—a highly toxic protein extracted from the castor bean plant—can be separated from many other proteins by liquid chromatography or electrophoresis. In some complex mixtures of proteins with similar chemical characteristics, however, the separation is not as clean. To address these cases, one can combine two or more different separation methods to provide sufficient selectivity. A major effort in liquid separations taking this approach is a handheld system known as μ ChemLab.²⁶ A recent version is capable of detecting a lethal dose of ricin starting with an aerosol sample, and new developments are under way that will increase the sensitivity by another factor of 100 needed to detect botulinum toxin in lethal doses.²⁷ Other groups are also investigating the use of new fluorescent dyes to achieve sensitive detection of proteins after separation using microfluidic systems.²⁸

²² T.J. Cornish and W. A. Bryden. 1999. Miniature time-of-flight mass spectrometer for a field-portable biodetection system. Johns Hopkins APL Technical Digest. 20:335-342.

W.A. Bryden, Johns Hopkins University. Presentation to the committee on September 25, 2002.

R.D. English and R.J. Cotter. 2003. A miniaturized matrix-assisted laser desorption/ionization time of flight mass spectrometer with mass-correlated acceleration focusing. J. Mass Spectrom. 38:296-304.

²³ E.R. Badman and R.G. Cooks. 2000. Miniature mass analyzers. J. Mass Spectrom. 35:659-671.

²⁴ English and Cotter, 2003. See note 22 above.

²⁵ R.J. Cotter. 1999. The new time-of-flight mass spectrometry. Anal. Chem. 71:445A-451A.

²⁶ D. Lindner. 2001. The μ ChemLab Project: Micro Total Analysis System R&D at Sandia National Laboratories. Lab on a Chip 1, 15N-19N.

²⁷ D. Lindner, Sandia National Laboratories. Presentation to the committee on September 25, 2002.

²⁸ Y.J. Liu, R.S. Foote, S.C. Jacobson, R.S. Ramsey, and J.M. Ramsey. 2000. Electrophoretic separation of proteins on a microchip

Capillary electrophoretic separation, fluorescent labeling, and detection are currently achieved in 5 minutes.²⁹ Aerosol sampling will require some additional time, and very dirty aerosol samples may require additional processing steps to achieve distinguishable detection peaks for toxin identification. Additional work is required to determine the reliability of this method for toxin identification in environmental aerosol samples. This method has the potential to be very rapid (2 minutes or less) for the detection of toxins in relatively simple samples such as aerosols that require minimal sample processing prior to separation, labeling, and detection of toxins.

A gas-phase version of μ ChemLab has been under development for a number of years. While this effort has been primarily directed toward the detection of chemical agents, recent work has evaluated the detection of cellular fatty acid components after chemical treatment to make them sufficiently volatile to be separated by gas chromatography. Gas chromatography of volatilized fatty acids for bacterial identification is well known, but these procedures are nearly always performed on pure samples of the microorganism isolated during lengthy cell culturing procedures that are not practical for rapid bioagent detection. Thus, while the achievement of sensitive protein separations in a handheld system represented by the μ ChemLab program is impressive, it is still an open research question whether it will be able to perform protein fingerprinting of viruses and bacteria in real-world samples.

A system that combines aerosol pyrolyses with gas chromatography and ion mobility spectrometry has been developed into a fieldable unit.³⁰ Ion mobility, like mass spectrometry, segregates ions by their velocity, but in a molecular gas rather than in a vacuum. While it does not have the selectivity of mass spectrometry, it may be somewhat simpler in design. Still, complexity and reliability issues for systems operated on a continuous basis without routine maintenance are potential limitations. Further, performance of these systems in environments containing large numbers of naturally occurring microorganisms has not been demonstrated. Therefore, as with MALDI-MS identification of bioagents, work is needed to determine the suitability of this approach for the identification of bioagents in the presence of naturally occurring microorganisms and other aerosols found in the environments that are being protected.

CHEMICAL SENSORS

As discussed in the introduction, biological organisms and molecules display chemical characteristics that can be exploited to detect and identify them through a variety of chemical sensors. Chemical sensors are versatile and available in many configurations that can be small in size, rapid in reporting information, and low in cost. If such sensors could be made reliable enough and cheap enough, it might be possible to use them as biological “smoke detectors” and distribute them widely throughout a building or other target that needs to be protected. When highly distributed, they are likely to be closer to any potential release and hence experience a still larger concentration of agent, thereby possibly lessening the stringent demands on discriminating an agent from the ambient background. It is this interplay of highly distributed and cheaper but simpler sensors that offers an intriguing trade space.

Chemical sensors consist of two essential components: a chemically selective layer that binds the target molecule and a transducer that converts the binding event into a measurable electrical signal that can be monitored, displayed, and used for process control. Box 8.2 summarizes several common types of chemical sensor transducers and offers some considerations for the design of chemical sensor systems. More detailed information on chemical sensors can be obtained from several review articles.³¹

with noncovalent, postcolumn labeling. *Anal. Chem.* 72(19):4608-4613.

²⁹ Lindner, 2001. See note 26 above.

³⁰ A.P. Snyder, W.M. Maswadeh, J.A. Parsons, A. Tripathi, H.L.C. Meuzelaar, J.P. Dworzanski, and M.G. Kim. 1999. Field detection of bacillus spore aerosols with stand-alone pyrolysis-gas chromatography-ion mobility spectrometry. *Field Anal. Chem. and Tech.* 3(4-5):315-326.

A.P. Snyder, W.M. Maswadeh, A. Tripathi, and J.P. Dworzanski. 2000. Detection of gram-negative *Erwinia herbicola* outdoor aerosols with pyrolysis-gas chromatography/ion-mobility spectrometry. *Field Analytical Chemistry and Technology* 4(2-3):111-126.

³¹ J. Janata, M. Josowicz, P. Vanysek, and D.M. DeVaney. 1998. Chemical sensors. *Anal. Chem.* 70:179R-208R.

Box 8.2 Chemical Sensors

Chemical sensors can include a wide variety of chemically interactive surfaces and transducers for detecting the binding of chemicals to the interactive surfaces. The chemically interactive layers can be designed to be selective to specific chemicals. Examples include sensors based on antibody-antigen interactions and sensors based on sequence-specific DNA hybridization. Sensors can also be designed to include semiselective films—i.e., those that will interact to varying degrees with many chemicals. In this case, greater selectivity can be achieved by using a collection of sensors with different chemically interactive surfaces.

This type of sensor array is analogous to our sense of smell. The olfactory system contains many different receptors that are not highly selective; each receptor will respond to many vapors, and a given vapor will elicit a response from many different receptors. In the same way, sensor arrays have been developed for vapor analysis in which each sensor includes a different cross-reactive layer and the fingerprint of the response from the sensor array is used to identify the vapors present. One potential advantage of a semiselective sensor array approach is that by understanding how the sensor elements interact with chemicals, it may be possible to obtain useful information about unknown samples, in order to classify the unknown and determine the potential risk it may pose.

Another approach to obtaining chemical selectivity using semiselective sensors is to combine information from sensors that operate using different transduction mechanisms. These are often called hybrid sensor array systems.^a In all sensor array systems, one tries to make the information reported from each of the sensors as independent as possible (perhaps using different operating principles or different modes of interactions with chemicals); otherwise, selectivity is correspondingly reduced.

A complete listing of all transduction methods, chemically interactive surfaces, and combinations of sensor elements into arrays for chemical sensing is beyond the scope of this report. However, below is a brief overview of several common chemical sensor transduction principles and some important considerations for designing sensors for pathogen detection. More detailed information on chemical sensors can be obtained in review articles focused on specific aspects of chemical sensing.^b

Transduction Principles

Three of the most common transduction principles for chemical sensing involve mass, electrochemical, and optical detection. Mass sensors can produce a signal based upon the mass of chemicals that interact with the sensing film. Acoustic wave devices are the most common sensors in this class. They are made of piezoelectric materials that bend when a voltage is applied to the crystal or that generate a voltage when they are bent. Acoustic wave sensors are typically operated by applying an oscillating voltage at the resonant frequency of the crystal and then measuring the change in resonant frequency when chemicals interact with the sensing surface.

In addition to mass, other properties such as surface viscosity can also affect the resonant frequency and must be considered when interpreting sensor response data. Two common types of acoustic wave devices are thickness shear mode devices (TSMs, also called quartz crystal microbalances, QCMs) and surface acoustic wave devices (SAWs). In TSM devices, the acoustic wave propagates through the bulk of the crystal, perpendicular to the sensor surface, while in SAW devices,

K. Haupt and K. Mosbach. 2000. Molecularly imprinted polymers and their use in biomimetic sensors. *Chemical Reviews* 100:2495-2504.

D.T. McQuade, A.E. Pullen, and T.M. Swager. 2000. Conjugated polymer-based chemical sensors. *Chemical Reviews* 100:2537-2574.

J.W. Grate. 2000. Acoustic wave microsensor arrays for vapor sensing. *Chem. Rev.* 100:2627-2648.

K.J. Albert, N.S. Lewis, C.L. Schauer, G.A. Sotzing, S.E. Stitzel, T.P. Vaid, and D.R. Walt. 2000. Cross-reactive chemical sensor arrays. *Chem. Rev.* 100:2595-2626.

P.C. Jurs, G.A. Bakken, and H.E. McClelland. 2000. Computational methods for the analysis of chemical sensor array data from volatile analytes. *Chem. Rev.* 100:2649-2678.

O.S. Wolfbeis. 2002. Fiber-optic chemical sensors and biosensors. *Anal. Chem.* 74:2663-2677.

the acoustic wave propagates along the surface of the crystal.

Electrochemical sensors involve using electrodes to measure the electrochemical changes that occur when chemicals interact with a sensing surface. The electrical changes can be based upon a change in the measured voltage between the electrodes (potentiometric), a change in the measured current at a given applied voltage (amperometric), or a change in the ability of the sensing material to transport charge (conductometric). Some of the most common types of electrochemical sensors are ion-selective electrodes (ISE) such as pH electrodes. These potentiometric sensors include a membrane that selectively passes certain ions, so that the potential drop across the membrane (and therefore the measured electrochemical potential) is dependent upon the concentration of ions in the sample.

Optical sensors often employ optical fibers or planar waveguides to direct the light to the sensing film. Evanescent waves propagating from waveguides can be used to optically probe only the sensing film, and not the bulk of the sample solution, in order to decrease the optical background signal from the sample. The measured optical signals can include absorbance, fluorescence, chemiluminescence, surface plasmon resonance (to probe refractive index), or changes in light reflectivity. The most sensitive optical sensors are based upon fluorescence measurements, and with sophisticated optical equipment, it is even possible to measure fluorescence from a single molecule.^c One practical limitation, however, is the limited lifetime of fluorescent molecules due to photobleaching over time. One example of an optical sensor array is a device developed by Walt and coworkers^d that includes a collection of hundreds of optical fibers, each with individual polymer beads containing embedded indicator dyes attached to the end.

Detection Formats

An important consideration in the development of a chemical sensor is the method by which the analyte interacts with the sensor to generate the signal.^e In a direct binding approach, the transducer can directly detect the analyte molecules, or the analyte displaces a reporter tag to decrease the sensor signal, or the analyte results in a change in the interactive film that is then measured by the transducer. In another format, a sandwich assay, a detector molecule such as an optical tag is added after the addition of the analyte and is designed to bind to the analyte, sandwiching the analyte between the chemically interactive surface and the optical tag. Many different direct binding and sandwich assays can be designed for use in combination with acoustic wave, electrochemical, and optical devices. Direct binding assays require only one binding step, so they are typically faster than sandwich assays, which require at least two binding steps. The use of additional tags, however, provides a means for designing a very sensitive sensor system. For instance, the tag can have a very large mass or include an immobilized enzyme that catalyzes a reaction to generate a multitude of fluorescent molecules that deposit onto an optical sensor surface for very high sensitivity. A highly desirable sensor platform for both rapid response and sensitive detection would therefore consist of a direct binding assay that generates a very large signal. This could be achieved by developing a very sensitive detector, or by designing selective films that are dramatically affected by the presence of the analyte, such that a small amount of analyte binding to the sensing surface generates a large sensor response.

Sensor Reversibility and Surface Fouling

Two important considerations for extended sensor operation and environmental monitoring are reversibility of the binding interaction and surface fouling. For a reversible binding interaction, a sensor response will be observed when the analyte is present but will rapidly return to baseline when the analyte is removed. Many vapor-polymer interactions used in sensor arrays for vapor analysis are reversible within seconds under normal operating conditions.^f Other interactions such as antibody-antigen binding or DNA hybridization require harsh conditions (e.g., high temperatures, low pH) to remove the bound analytes. The harsh conditions can affect the quality of the interactive surface and therefore limit the lifetime of the sensor. Some sensors are designed to be used until a positive signal is

obtained and then thrown away, rather than cleaned for continued use. Reuse of sensor surfaces is desirable to decrease reagent use and operation cost. Preliminary work will be needed to establish the number of times a sensor can be reused before it needs to be regenerated or replaced due to accumulation of nonspecifically bound compounds.

Surface fouling can also limit the lifetime of chemical sensors. Surface fouling is the nonspecific binding of chemicals in the sample matrix onto the sensor surface. Surface fouling can result in false positive signals or completely destroy the operation of the sensor by interfering with analyte-sensing surface interactions, giving false negative signals. In some cases, it is possible to clean sensor surfaces periodically to remove contamination. If chemical cleaning is used to remove analytes and nonspecifically bound molecules, one must ensure that the sensor is not compromised. A method for automated cleaning and storage of cleaning materials within the sensor system may need to be developed prior to deployment of a sensor system.

If continuous or periodic monitoring over extended periods of time is desired, it is often necessary to engineer the sensor system to produce a new sensing surface automatically for each measurement, or to replace the sensing surface periodically as surface fouling occurs. This can be achieved by using many different engineering approaches. For example, a moving tape is being used for collecting each aerosol sample within the MALDI-TOF mass spectrometry system under development at Johns Hopkins Applied Physics Laboratory.^g This same approach could be used to produce a moving interactive chemical sensor surface for chemical sensing. Another approach that has been used to mitigate problems with sensor reversibility and surface fouling is the use of beads as interactive surfaces within a sensor system. Fresh interactive beads can be fluidically delivered to the transducer before each measurement and removed from the sensor system after each measurement.^h The beads are therefore disposed of after each measurement (or periodically after surface fouling buildup), and only pristine interactive surfaces are used for detection. Problems with limited sensor lifetime and surface fouling can sometimes also be minimized by adding sample preparation steps that remove chemicals that cause problems, before they have a chance to damage the sensing surface or interfere with the sensor response.

This overview of chemical sensors only touches the surface regarding the multitude of chemically interactive films, chemical transducers, sensor arrays, and other considerations that must be taken into account when developing chemical sensor systems. In order to develop effective chemical sensors, it is critical to first understand the operating requirements and sample type, and to consider the complete system, from sample acquisition through detection and data analysis, since these requirements can dramatically change the selection of the chemical sensor system and sensing strategy.

^a C.M. McEntegart, W.R. Penrose, S. Strathmann, and J.R. Stetter. 2000. Detection and discrimination of coliform bacteria with gas sensor arrays. *Sensors and Actuators B-Chemical* 70:170-176.

K.J. Albert, N.S. Lewis, C.L. Schauer, G.A. Sotzing, S.E. Stitzel, T.P. Vaid, and D.R. Walt. 2000. Cross-reactive chemical sensor arrays. *Chem. Rev.* 100:2595-2626.

^b Albert et al., 2000. See note *a* above.

J.W. Grate. 2000. Acoustic wave microsensors for vapor sensing. *Chem. Rev.* 100: 2627-2648.

J. Janata, M. Josowicz, P. Vanysek, and D.M. DeVaney. 1998. Chemical sensors. *Analytical Chemistry* 70:179R-208R.

P.C. Jurs, G.A. Bakken, and H.E. McClelland. 2000. Computational methods for the analysis of chemical sensor array data from volatile analytes. *Chem. Rev.* 100:2649-2678.

^c X.S. Xie and R.C. Dunn. 1994. Probing single molecule dynamics. *Science* 265:361-364.

^d D.R. Walt. 2000. Bead-based fiber-optic arrays. *Science* 287:451-452.

Albert et al., 2000. See note *a* above.

^e K. Haupt and K. Mosbach. 2000. Molecularly imprinted polymers and their use in biomimetic sensors. *Chemical Reviews* 100:2495-2504.

^f J.W. Grate. 2000. Acoustic wave microsensors for vapor sensing. *Chem. Rev.* 100:2627-2648.

^g C.W. Anderson and M.A. Carlson. 1999. A time-of-flight mini-mass spectrometer: Aerosol collection, capture, and load-lock system. *Johns Hopkins APL Technical Digest* 20:352-362.

^h D.P. Chandler, F.J. Brockman, D.A. Holman, J.W. Grate, and C.J. Bruckner-Lea. 2000. Renewable microcolumns for solid-phase nucleic acid separations and analysis from environmental samples. *Trends Anal. Chem.* 19:314-321.

Many of the chemical sensors that have been investigated for pathogen detection are based upon the sequence-based recognition of DNA, structural recognition of pathogens or pathogen biomarkers, or cell-based function. These are discussed in Chapters 6, 7, and 9, respectively. This chapter focuses on chemical sensors for pathogen detection that respond to the chemical nature of pathogen biomarkers.

One of the challenges in the development of chemistry-based sensors for pathogen detection is the selection of pathogen biomarkers. Most chemical biomarkers discussed in this chapter are semiselective—that is, the biomarker may distinguish between general classes of microorganisms but will not be able to identify the specific species or strain of organism. For example, calcium dipicolinate is a unique component of endospores. Therefore, dipicolinic acid can be used to indicate the presence of endospores but will not be able to distinguish between dangerous *Bacillus anthracis* spores and other nontoxic *Bacillus* spores.³² An even more general indicator, such as the presence of DNA, will be useful for determining that an unknown material is biological in nature but will not be able to discriminate the source of the biological material (unless sequence-based analysis is used, as discussed in Chapter 6). Cell metabolites will also be very difficult to use as specific markers for pathogens. Metabolites are generally common to many different cell types and therefore difficult to use for discrimination between specific microorganisms. In addition, the concentration and distribution of metabolites often depend upon the nutrients available, and so can vary even for the same cell types.

In spite of the inherent limitations of semiselective pathogen detection, this approach could be useful if it is used to trigger more selective pathogen detection systems, which typically require more time and expense for each analysis. Assuming the false alarm rate can be made sufficiently low, semiselective pathogen detection could also be used to trigger initial low-regret responses—such as alterations in building ventilation—while waiting for confirmation using more selective pathogen identification systems.

It may be possible to decrease the number of false alarms by developing sensor arrays that detect multiple pathogen biomarkers simultaneously. This concept of sensor arrays has been widely used in the field of vapor analysis. In this approach, each element of the array is designed to respond to different general properties of vapors. The specific identification of the vapors present therefore relies on the use of statistical methods to identify the vapor from the fingerprint of the response from all array elements. A similar approach could be used for pathogen detection, in which each element of an array responds to different properties (e.g., pathogen biomarkers) of an organism. Such an approach would require a well-characterized environmental background signal and research to determine the fingerprints that would constitute a positive signal. If this approach is successful, it is expected that the first generations of such bio smoke detectors would be more expensive than conventional smoke alarms, so that these sensors might need to be distributed more sparsely than smoke alarms. A cost-benefit analysis will be needed to determine whether and under what conditions such a sparse network makes sense. If the analysis shows that such a network can be cost-effective and can address a significant portion of the threat space, methods will be needed for determining the optimum placement of the sensors and how to extract information from a sparse detection network.

The use of chemical sensors for semiselective pathogen detection is an area that has not been extensively investigated. Below are a few examples of chemical sensors that are being developed.

Dipicolinic Acid Analysis

An endospore (spore) is a dormant state that is exhibited by some gram-positive bacteria (e.g., *Bacillus anthracis* or *Clostridium perfringens*) when they are under stress or deprived of nutrients. Spores are particularly resistant to chemical and physical damage and can survive for decades. When the appropriate nutrients and conditions are present, endospores germinate into vegetative cells. Often the conditions within other biological systems (e.g., humans) are suitable for spore germination. For these reasons, spores represent one class of bioagents that are of special concern. As mentioned previously, one chemical marker for the presence of spores is calcium dipicolinate (dpa). Endospores typically

³² *Bacillus* spores are very widely distributed in the environment.

contain 2 to 15 percent dpa by dry weight, so this marker has the potential for sensitive detection of the presence of spores.³³

In addition to pyrolysis followed by gas chromatography (GC)-MS or GC-ion mobility spectrometry, described above, several chemical sensing approaches have been reported for the detection of dpa.³⁴ Photoluminescence of a terbium-dipicolinate complex is the most sensitive method that has been reported. This method involves first extracting the dipicolinic acid from the cells and then adding excess terbium to form a terbium-dipicolinate complex that is detected. Photoluminescence is generated by irradiating the sample at the wavelength absorbed by dpa (280 nanometers). Energy transfer from dpa to the terbium excited state dramatically enhances the terbium luminescence. Terbium luminescence contains several characteristic narrow emission peaks between 490 and 695 nanometers and has an unusually long fluorescence lifetime, so that the luminescence can be distinguished from interfering fluorescence in biological samples.³⁵ Scientists at the U.S. Army Research Laboratory have demonstrated a limit of detection of 1,000 cfu per milliliter in a total analysis time of 5 to 7 minutes.³⁶ This analysis time included 3 minutes for a rapid chemical extraction procedure to release virtually all of the dpa from the spores and all additional reagent additions prior to photoluminescence detection. Some dpa is released even without the extraction procedure; therefore, high concentrations of spores can currently be detected in a liquid sample in only 2 to 4 minutes. The use of microfluidic reaction chambers could further shorten this analysis time. Research has also been conducted to determine sample constituents that will interfere with the photoluminescence detection, and a method has been developed to mitigate the interference caused by the presence of phosphate ions.³⁷ Further challenges include automating and miniaturizing the reagent additions and sample processing steps.

The terbium-dpa photoluminescence method for spore detection is well suited for implementation in a wet chemistry lab. However, additional research and development would be required in the areas of microfluidics, reagent storage, and optical sensor systems to develop a small, integrated sensor system that could automatically analyze liquid samples generated from an aerosol sampler. As with the other dpa detection methods discussed previously in this chapter, this semiselective assay will only detect the presence of spores, so for general pathogen detection, strategies must be developed to combine this assay with additional sensors that detect other pathogens of concern. If the detection of a wide range of

³³ Dipicolinic acid is only present in the interior of the spore and is not part of the cell wall; thus, dpa must somehow be extracted from the cells to be tested.

³⁴ P.M. Pellegrino, N.F. Fell, and J.B. Gillespie. 2002. Enhanced spore detection using dipicolinate extraction techniques. *Analytica Chimica Acta* 455:167-177.

D.C. White, C.A. Lytle, Y.D.M. Gan, Y.M. Piceno, M.H. Wimpee, A.D. Peacock, and C.A. Smith. 2002. Flash detection/identification of pathogens, bacterial spores and bioterrorism agent biomarkers from clinical and environmental matrices. *Journal of Microbiological Methods* 48(2-3):139-147.

A.P. Snyder, W.M. Maswadeh, J.A. Parsons, A. Tripathi, H.L.C. Meuzelaar, J.P. Dworzanski, and M.G. Kim. 1999. Field detection of bacillus spore aerosols with stand-alone pyrolysis-gas chromatography-ion mobility spectrometry. *Field Analytical Chemistry and Technology* 3(4-5):315-326.

R. Goodacre, B. Shann, R.J. Gilbert, E.M. Timmins, A.C. McGovern, B.K. Alsberg, D.B. Kell, and N.A. Logan. 2000. Detection of the dipicolinic acid biomarker in *Bacillus* spores using Curie-point pyrolysis mass spectrometry and Fourier transform infrared spectroscopy. *Anal. Chem.* 72:119-127.

R. Nudelman, B.V. Bronk, and S. Efrima. 2000. Fluorescence emission derived from dipicolinic acid, its sodium, and its calcium salts. *Applied Spectroscopy* 54:445-449.

A.A. Hindle and E.A.H. Hall. 1999. Dipicolinic acid (DPA) assay revisited and appraised for spore detection. *Analyst* 124:1599-1604.

D. Helm and D. Naumann. 1995. Identification of some bacterial-cell components by FTIR spectroscopy. *FEMS Microbiology Letters* 126:75-79.

S.S. Iqbal, M.W. Mayo, J.G. Bruno, B.V. Bronk, C.A. Batt, and J.P. Chambers. 2000. A review of molecular recognition technologies for detection of biological threat agents. *Biosensors and Bioelectronics* 15:549-578.

³⁵ N.F. Fell, P.M. Pellegrino, and J.B. Gillespie. 2001. Mitigating phosphate interference in bacterial endospore detection by Tb dipicolinate photoluminescence. *Analytica Chimica Acta* 426:43-50.

P.M. Pellegrino, N.F. Fell, and J.B. Gillespie. 2002. Enhanced spore detection using dipicolinate extraction techniques. *Analytica Chimica Acta* 455:167-177.

³⁶ Pellegrino et al., 2002. See note 35 above.

³⁷ Fell et al., 2001. See note 35 above.

pathogens is required, a more generalized detection methodology and platform that can include an array of sensors or other multiplexed assay would be useful.

DIRECT LABELING OF PATHOGENS FOR DETECTION

The use of direct labeling of pathogens followed by rapid detection has been demonstrated using detection formats such as flow cytometry and optical detection on a planar sensor. The general advantage of this approach is that only one binding step is used for detection, and sample processing (other than aerosol collection) was not used for the implementations described below.

Flow Cytometry

Flow cytometry has been investigated as an approach for the detection and classification of organisms based upon their light-scattering properties (size) and direct labeling of their DNA using fluorescent dyes.³⁸ Flow cytometry has also been used in combination with structural-based recognition (discussed in Chapter 7) for selective pathogen identification by, for example, labeling cells with fluorescently labeled antibodies. While structural-based recognition can be very selective, chemistry-based analysis described in this section is semiselective, and the analysis of multiple cross-correlated parameters is required to improve selectivity.

Flow cytometry has been used to differentiate organisms from background particles by labeling their DNA. A 100 microliter liquid sample was mixed with 100 microliters of a micromolar concentration of fluorescent dye that labels DNA and incubated for 3 minutes. After dilution with a buffer solution, the particles were analyzed using a flow cytometer, which optically analyzes the light scattering and fluorescence of individual particles (e.g., cells). A total analysis time of less than 5 minutes was needed (not including aerosol sampling), with a detection limit of 1,000 cfu per milliliter. Due to the analysis of two parameters—particle size and DNA content—there was some ability to discriminate between organisms and background particles and also some ability to identify classes of organisms due to their differences in size and shape. This example highlights the utility of collecting additional sample parameters when using semiselective pathogen detection approaches.

Planar Sensors

Semiselective biodetection can also be achieved by directly labeling components of pathogens upon adsorption to a sensor surface. Because many types of planar chemical sensors can be miniaturized, strengthened, and cheapened, this general approach, with further development, has the potential to be used as a biological smoke detector that could be distributed throughout facilities. In one approach, scientists are developing a pathogen detection system that includes fluorescent dyes immobilized onto a quartz substrate or optical fiber.³⁹ The system is designed so that the fluorescence signal is enhanced when analytes of interest bind to fluorescent dye molecules that are immobilized onto the sensor surface. For example, semiselective detection of bacterial spores is achieved by immobilizing calcein dye on the sensor surface, which binds to the calcium ions associated with the spores. The spore detection limit was 1,000-2,000 spores on the sensor surface, and spores could be accumulated either from microdroplets of solution⁴⁰ or by direct aerosol deposition in a humid environment.⁴¹ Data collection was typically accomplished in 10 to 30 minutes; however, positive signals could be seen in 2 minutes, indicating that

³⁸ S.A. Sincoc, H. Kulaga, M. Cain, P. Anderson, and P.J. Stopa. 1999. Applications of flow cytometry for the detection and characterization of biological aerosols. *Field Anal. Chem. Technol.* 3:291-306.

³⁹ L.C. Taylor, M.B. Tabacco, and J.B. Gillespie. 2001. Sensors for detection of calcium associated with bacterial endospore suspensions. *Analytica Chimica Acta* 435:239-246.

H. Chuang, P. Macuch, and M.B. Tabacco. 2001. Optical sensors for detection of bacteria. 1. General concepts and initial development. *Anal. Chem.* 73:462-466.

⁴⁰ Taylor et al., 2001. See note 39 above.

⁴¹ M.B. Tabacco, Echo Technologies. Presentation to the committee on September 26, 2002.

this approach has the potential for rapid detection if 1,000 to 2,000 spores can be rapidly delivered to the sensor surface.

Achieving pathogen selectivity using this approach is a challenge. Substitution of bacteria or pollen at the same concentration as the bacterial spores resulted in a signal that was about 20 percent of the spore signal. On the other hand, fungal spores resulted in a decrease in signal of about 20 percent.⁴² These data suggest that the response from a single sensor would be impossible to interpret. Current work is proceeding to combine data from multiple sensors in order to improve the discrimination of the sensor system.

Other dyes under investigation include nucleic acid dyes to detect primarily bacteria and viruses⁴³ and protein dyes to detect toxins. The DNA dyes will stain all nucleic acids, and the protein dye binds electrostatically to COOH and OH groups, so complete characterization of the sensors in environmental samples will be required to determine the utility of these semiselective sensors. The detection limit for DNA-based detection of organisms is currently 1,000 organisms bound to the sensor surface,⁴⁴ and the detection limit for cholera toxin is currently 120 nanomoles.⁴⁵ Encouraging data have also been obtained that indicate that binding of the fluorescent dye molecules to the many identical binding sites on dendrimers can increase the optical signal and improve the stability of a fluorescent dye used for DNA staining. This work also points out one challenge in the comparison of the performance of different sensor systems: It is very difficult to compare the performance of systems when the measurements are obtained and reported in different ways (e.g., solution concentration vs. amount of analyte bound to sensor surface, milligrams per milliliter vs. moles per liter vs. molecules per milliliter). Common guidelines regarding the reporting of the testing and performance of pathogen detection systems would aid in the comparison and evaluation of various sensor systems.

Direct fluorescent labeling of pathogen components bound to the sensor surface offers the potential for very rapid response for air monitoring applications since aerosols can be deposited directly on the sensor surface for analysis. In general, it is desirable to minimize the number of processing steps if very fast sensor response (less than 5 minutes) is required. In addition, the optics required (488 nanometer excitation, visible wavelength detection) can be small and relatively inexpensive. Some limitations of this approach are the sensitivity of the system to baseline instability and the effect of environmental sample matrices on the baseline signal and sensor response when relying only on an enhanced fluorescence signal upon binding (rather than a wavelength shift, for example, which is more easily distinguished). In addition, from current data it is not clear that the detection limit of the direct detection method will be suitable in the 2-minute time frame owing to the time required for mass transport to enable dye to interact with the pathogen materials (reported detection limits are obtained after data accumulation times typically ranging from 10 to 30 minutes). However, for high concentrations of agent, a 2-minute analysis time may be possible.

The current systems under development are promising for rapid semiselective monitoring but are not yet ready for deployment. Since this is a dry assay, material will accumulate on the sensor surface after each use, and additional work is needed to develop a method for automatically renewing the sensor surface (see Box 8.2). Extensive testing of an array of several different types of semiselective sensors is required to characterize environmental backgrounds, quantify the number of false positives, and determine the detection limit under actual operating conditions of interest. The ability to detect single fluorescent-labeled organisms in microfluidics systems⁴⁶ suggests that the detection sensitivity of inexpensive, portable sensor systems can also be improved in the future. Other sensor platforms (see

⁴² Taylor et al., 2001. See note 39 above.

⁴³ Chuang et al., 2001. See note 39 above.

⁴⁴ Taylor et al., 2001. See note 39 above.

A.C. Chang, J.B. Gillespie, and M.B. Tabacco. 2001. Enhanced detection of live bacteria using a dendrimer thin film in an optical biosensor. *Anal. Chem.* 73:467-470.

⁴⁵ Tabacco, 2002. See note 41 above.

⁴⁶ M.A. McClain, C.T. Culbertson, S.C. Jacobson, and J.M. Ramsey. 2001. Flow cytometry of *Escherichia coli* on microfluidic devices. *Anal. Chem.* 73:5334-5338.

Box 8.2) may also be suitable approaches for semiselective detection based on Ca^{++} , DNA, and protein detection.

VAPOR ANALYSIS OF CELL METABOLITES

Standard sensors for environmental monitoring (e.g., particle, CO_2 , temperature, vapor, or humidity sensors) may be useful additions to a sensor array to detect situations that are abnormal and therefore trigger additional analysis using more specific sensor systems for pathogen detection.

Some work has been done to investigate the use of vapor sensor arrays, often termed "electronic noses," for bacterial monitoring and detection. This approach does not involve direct detection of the bacteria themselves but of volatile compounds emitted by the bacteria or bacterial preparations. In general, relatively high cell concentrations in solution or on cell culture plates are required in order to obtain detectable levels of vapor for bacterial identification by vapor analysis of the air in close proximity to the bacterial sample. However, this approach may be useful as a trigger to initiate analysis by more selective sensor systems. The response times of vapor sensor arrays are on the order of seconds, and the vapor interactions are reversible, so that rapid air monitoring can be done over extended periods of time with a single sensor array. A rugged vapor sensor system will have to be designed to prefilter particles that will foul the sensor surface, or the surface will have to be renewed periodically when surface fouling occurs. The committee is not aware of any studies investigating vapors emitted from spores. However, it is expected that vapors emitted from spores would be derived from materials associated with the spore coat and related to the method of spore preparation and aerosol formation.

This approach has been applied successfully to situations such as bioprocess monitoring, medical diagnosis,⁴⁷ or the detection of food spoilage.⁴⁸ Some work has also been done to use the signatures obtained using vapor sensor arrays to distinguish between several bacteria in mixtures,⁴⁹ but detection levels do not currently look promising for facility protection. For example, in one study, 5×10^8 cells per milliliter was sufficient to detect organisms and distinguish between *Enterobacter aerogenes* and *Escherichia coli*; however, different *E. coli* strains could not be distinguished under any conditions.⁵⁰

Microscale Monitoring of Cell Metabolites

With progress in microfluidic systems and improvements in the sensitivity of chemical sensors, there is ongoing research in monitoring the environment and metabolites of very small volumes either within cells or in the surrounding medium. For example, optical nanosensors are being developed for monitoring analytes within and around individual cells,⁵¹ and methods are under development for manipulating and analyzing single cells on microfluidic chips.⁵² While these approaches may not be suitable for environmental monitoring for pathogen detection owing to practical issues such as organism sampling,

⁴⁷ T. Bachinger and C.F. Mandenius. 2000. Searching for process information in the aroma of cell cultures. *Trends in Biotechnology* 18:494-500.

T.D. Gibson, O. Prosser, J.N. Hulbert, R.W. Marshall, P. Corcoran, P. Lowery, E.A. Ruck-Keene, and S. Heron. 1997. Detection and simultaneous identification of microorganisms from headspace samples using an electronic nose. *Sensors and Actuators B-Chemical* 44:413-422.

⁴⁸ Y. Blixt and E. Borch. 1999. Using an electronic nose for determining the spoilage of vacuum-packaged beef. *International Journal of Food Microbiology* 46:123-134.

⁴⁹ Gibson et al., 1997. See note 47 above.

M. Holmberg, F. Gustafsson, E.G. Hornsten, F. Winquist, L.E. Nilsson, L. Ljung, and I. Lundstrom. 1998. Bacteria classification based on feature extraction from sensor data. *Biotechnology Techniques* 12:319-324.

C.M. McEntegart, W.R. Penrose, S. Strathmann, and J.R. Stetter. 2000. Detection and discrimination of coliform bacteria with gas sensor arrays. *Sensors and Actuators B-Chemical* 70:170-176.

⁵⁰ McEntegart et al., 2000. See note 49 above.

⁵¹ J.Z. Lu and Z. Rosenzweig. 2000. Nanoscale fluorescent sensors for intracellular analysis. *Fresenius Journal of Anal. Chem.* 366:569-575.

H.A. Clark, M. Hoyer, M.A. Philbert, and R. Kopelman. 1999. Optical nanosensors for chemical analysis inside single living cells. 1. Fabrication, characterization, and methods for intracellular delivery of PEBBLE sensors. *Anal. Chem.* 71:4831-4836.

⁵² P.C.H. Li and D.J. Garrison. 1997. Transport, manipulation, and reaction of biological cells on-chip using electrokinetic effects. *Anal. Chem.* 69:1564-1568.

nanosensor handling, and system clogging, developments in this area could someday lead to the future realization of smaller, cheaper, and more sensitive chemical sensors and the identification of additional biomarkers and methodologies for semiselective biodetection.

FINDINGS AND RECOMMENDATIONS

Finding 8-1: Nearly all encouraging results in the use of mass spectrometry for microorganism identification have been achieved under conditions in which the target organism is present in much higher concentrations than other potentially interfering background organisms. Limited work has been conducted to determine the potential of this approach to accurately identify bioagents in circumstances where the agent organism is present with equal or greater numbers of naturally occurring organisms and other background components. It may be expected, however, that several ongoing efforts in this area may show increasing promise as new data become available.

Recommendation 8-1: Further research in the rapid identification of bioagents using mass spectrometry should be focused on determining the capabilities (e.g., detection limit, selectivity, reproducibility, and total analysis time) of this approach for bioagent identification in complex environmental backgrounds that include the concentration, diversity, and variability of naturally occurring microorganisms and inorganic particles that are expected to be present in deployment circumstances. These activities should be pursued using the best-performing laboratory mass spectrometers. To the extent that recent MALDI mass spectrometry activities show improved detection performance and discrimination in the presence of interfering backgrounds, spectrometers in this class may deserve a higher priority.

Finding 8-2a: Detection of chemicals that are markers for semiselective biodetection can potentially be accomplished in less than 1 minute using small, relatively low-cost sensors, but very little work has been done in this area, and off-the-shelf solutions are not available.

Finding 8-2b: An unacceptable number of false positives is expected if only one semiselective sensor is used. The most promising approach is likely to be the development of sensor arrays that consist of combinations of semiselective sensors and the use of statistical methods to determine if the responses of the sensors in combination indicate that further analysis or action is required. Further research is needed to determine the selectivity that can be obtained by using semiselective biodetection arrays to measure pathogen releases of concern.

Finding 8-2c: Continuous monitoring at 1- to 2-minute intervals will require rapid, reversible detection chemistry or a means to renew the sensing surface between analyses.

Recommendation 8-2: Further research is needed on semiselective sensors in the following areas:

- Identification of detectable biomarkers and/or classes of biomarkers that can be used to improve selectivity, and development of methods for analyzing information obtained from multiple rapid sensors (sensor arrays).
- Rigorous characterization of the signal/noise (environmental plus instrument noise) of the sensor arrays under operating conditions in the environment. If the signal/noise is not suitable for detection, research should be conducted to improve the sensitivity of transducers and to develop better labels and detection methods that are not affected by the environmental background signal.
- Development of reporter tags and transduction methods that minimize the number of steps for binding and detection.
- Methods for efficient integration of the sensors with aerosol collectors.
- Methods for enhancing mass transport of analytes to the chemically interactive sensing surface.
- Development of reversible detection chemistries or methods for renewing the sensing surface between analyses.

Finding 8-3: It is very difficult to compare the performance of sensor systems when the measurements are obtained and reported in different ways (e.g., solution concentration vs. amount of analyte bound to sensor surface; milligrams per milliliter vs. moles per liter vs. molecules per milliliter).

Recommendation 8-3: Common guidelines for reporting of the testing and performance of pathogen detection systems should be developed. This would aid in the comparison and evaluation of various sensor systems.

9

Function-Based Detection

For the purposes of this report, a function-based detector is defined as a naturally occurring biological organism or portion of that organism (whether organ, tissue, cell, or receptor) that reacts in a measurable way when exposed to a range of chemical or biological toxic material.

Historically, many sentinel animals have been used as detectors, indicators, and alarms for the presence of toxic agents. The use of caged canaries by miners to detect methane in coal mines is well known. The canary is highly sensitive to methane, an odorless gas that is found in mines. If the caged canary died it provided a visible functional alarm, warning the miners that they should leave the area. Similarly, Japanese police used caged canaries to detect sarin during raids on the Aum Shin Rikyo enclaves. Chickens are used as sentinels on the Canadian border to detect encephalitis virus.

There has been widespread use of biological systems in environmental quality testing to provide an integrated picture of overall toxicity of an effluent or a sample of water, sediment, or soil from a contaminated site.¹ Fathead minnows, various aquatic invertebrates, earthworms, protozoans, and seeds are all used for bioassays of aquatic samples.² *Daphnia* (small freshwater crustaceans) are also used to provide an indication of water quality. They are sensitive to changes in water chemistry and their response to toxicants can be readily monitored.³ The Center for Environmental Research at Fort Detrick uses bluegill fish as sensing systems. During Operation Freedom in Iraq in the spring of 2003, soldiers were reported to carry chickens in cages on the hoods of their vehicles to serve as chemical weapon sentries. The many unknowns surrounding Gulf War Syndrome have prompted soldiers to act independently in order to protect themselves from compounds that may not be detected by existing equipment. The ad hoc employment of an uncharacterized function-based detection system in the front lines indicates the need for more research in this area.

Function-based detection systems are similar to the structure-based biosensors discussed in Chapter 7 in that they do not measure the concentration of biological agent directly but rely on some form of transduction device to measure response. However, the two methods differ greatly in their specificity. Structure-based identifiers (examples include nucleic acid primers and antibodies) are highly specific but

¹ F. Botre, E. Podesta, B. Silvestrini, and C. Botre. 2001. Toxicity testing in environmental monitoring: The role of enzymatic biosensors. *Ann. Ist. Super. Sanita.* 37:607-613.

² C.J. Keddy, J.C. Green, and M.A. Bonnell. 1995. Review of the whole organism bioassays: Soil freshwater sediment and freshwater assessment in Canada. *Ecotoxicity and Environmental Safety* 30:221-251.

³ U.S. Environmental Protection Agency. 1991. *Methods for Measuring the Acute Toxicity of Effluents to Aquatic Organisms.* Cincinnati, Ohio: Environmental Protection Agency.

are only able to recognize certain structural elements that have previously been characterized and prepared for. Function-based detectors, on the other hand, can react to previously uncharacterized structures that affect the monitored biological functions. Thus, function-based detectors are less specific or selective but have the potential for detecting the presence of unknown chemical and biological agents. Initially, research in this area focused on chemical toxicants; it is only recently that function-based techniques have been applied to the detection of biological warfare agents.

Currently, there are a wide variety of biosensing systems that could fall under the banner of functional. These include enzyme systems, ion channel/receptors, cells, and whole organisms.⁴ Table 9.1 provides a basic comparison of various recognition elements and the level of information they can provide. Antibodies and synthetic ligands can be generated to recognize a specific epitope (structural element). These recognition elements can be highly specific or common to various target organisms. For example, a given monoclonal antibody may identify a specific *Bacillus* species, while another may recognize all *Bacillus* species. Similarly, nucleic acid-based identification sequences can be specific to the strain level, or they can be directed to conserved regions of particular genomes. Enzymes and cellular chemistries are modulated by compounds that affect their active site and thus modulate their function. Since modulation of most enzyme activities is accomplished by the natural substrate as well as structural analogs, the information generated is rather generic; e.g., inhibition of cholinesterase activity by various nerve agents. Similar restrictions of specific identification apply to receptors, cells, and whole organisms. These systems are valuable for providing functional information regarding potentially harmful material in the environment. While the ability to identify harmful material for which no specific assay exists is important, one must also consider the fact that the response of an isolated cell may or may not model the response of humans to the same challenge. Differential responses among multiple function-based sensing elements (e.g., different cell types) may provide fingerprints of various classes of compounds in much the same way that surface acoustic wave devices identify chemicals (see Chapter 8).

There is a very fine line dividing structure-based and function-based detection systems. In the following examples, hybrid systems exploit part of the functional process within a cell-based response system, even as they are targeted at a specific characterized function.

The canary-on-a-chip concept,⁵ which uses genetically engineered B cells or B lymphocytes with the appropriate antibody incorporated into the genome and displayed on the cell surface, is an example of a biosensing system that exhibits characteristics of a functional detector but is reliant on having a specific

TABLE 9.1 Type of Information Provided by Various Recognition Systems

Recognition Element	Functional Information	Specific Identification ^a	Generic Detection and Classification
Antibodies		✓	✓
Nucleic acids		✓	✓
Synthetic ligands		✓	✓
Enzymes/cellular chemistry	✓		✓
Ion channel/receptors	✓		✓
Cell	✓		✓
Whole organisms	✓		✓

^a Relies on a specific binding event (e.g., gene probe primer sets for a given organism or antibody antigen binding).

⁴ J. Pancrazio, Naval Research Laboratory. Presentation to the committee on September 26, 2002.

⁵ J.D. Harper, MIT Lincoln Laboratory. Discussions with the committee on June 13, 2002.

antibody for the recognition event. Similarly, an ion channel system⁶ is based on an approach that consists of ion channels embedded in lipids that have antibodies bound to the lipid layers. Again, this approach is dependent on having a specific targeting antibody. Both of these types are discussed in detail in Chapter 7.

A well-known example of an enzyme inhibition system is the U.K.'s NAIAD, a nerve agent detector used for a military application.⁷ The bioreceptor in this case is the enzyme butyrylcholinesterase, which exhibits the same enzyme activity as human acetylcholinesterase. The enzyme is immobilized onto a temperature-controlled pad that is continually washed with butyrylthiocholine methane sulfonate in an aqueous phosphate buffer. The enzyme catalyses the hydrolysis of the ester, producing butyrylthiocholine, and the concentration is monitored by an electrochemical cell arrangement (this is the transduction system). If nerve agent is present, it inhibits the butyrylcholinesterase, which in turn causes an alteration in the electrical potential within the electrochemical cell, thus triggering an alarm at a preset level. This type of detector is extremely sensitive to low levels of nerve agents such as tabun and sarin.

Enzymes have been used in assay systems for some time. A good example is the bioluminescence assay using the enzyme luciferase (present in fireflies). This assay is used widely to measure bacterial contamination in a number of sectors—e.g., food industry, defense, and health care. It is based on the level of adenosine triphosphate (ATP) present within a bacterial cell; however, the amount of ATP present varies depending on the bacterial species and the cell state. An example of an enzyme amplification system that improves sensitivity levels is the use of adenylate kinase (AK), an enzyme present in the cell that converts adenosine diphosphate (ADP) to ATP. By exploiting this reaction, the bioluminescence assay sensitivity can theoretically be increased 40,000-fold. A bioluminescence assay method has been developed⁸ in which the AK is extracted from the bacterial cell and ADP is added in excess. The ADP is converted to ATP and then the conventional ATP bioluminescent assay is carried out. This method significantly increases the detection sensitivity by orders of magnitude.

CELL-BASED RESPONSE SYSTEMS

A functional detection system relies on the cell to respond in a measurable way to a toxic agent. For example, fish are sensitive indicators of their environment. Fish kills are frequent indicators of toxins as well as low oxygen levels in their environments.⁹ The U.S. military is using whole fish as sensing agents for environmental monitoring. The whole organism can be monitored remotely to look for changes in behavior that are indicators of changes in the environment. Isolated fish chromatophore cells can also be used as a detection system.¹⁰ This approach exploits the ability of living chromatophores to respond to many active substances such as bacterial toxins; the response of the chromatophore is measured as changes in the appearance of the cell due to intracellular activity of the colorants.¹¹

Tissue biosensors made from immobilized whole-cell photosynthetic microorganisms have been developed for airborne chemical warfare agents and simulants. This is based on fluorescence induction by living photosynthetic tissue. Photosynthetic prokaryotes and eukaryotes fluoresce when illuminated by light following a period of darkness. Structural differences between the two types of organisms affect the fluorescence signal produced, and their sensitivity to perturbing factors such as toxicants alters the

⁶ B.A. Cornell, V.L.B. Braach-Maksvytis, L.G. King, P.D.J. Osman, B. Raguse, L. Wiczoreck, and R.J. Pace. 1997. A biosensor that uses ion-channel switches. *Nature* 387:580-583.

⁷ R.J. Powell. 1988. Detectors in battle. *Chemistry in Britain* July:665-669.

⁸ D.J. Squirrell and M.J. Murphy. 1994. Adenylate kinase as a cell marker in bioluminescence assays. *Bioluminescence and Chemiluminescence—Fundamentals and Applied Aspects*. A.K. Cambell, L.J. Kricka, and P.E. Stanley, eds. Chichester: John Wiley, pp. 486-489.

⁹ U.S. Environmental Protection Agency. 1991. *Methods for Measuring Acute Toxicity of Effluents of Receiving Water to Freshwater and Marine Organisms*. Washington, D.C.: Environmental Protection Agency.

¹⁰ F.W. Chaplen, R.H. Upson, P.N. McFadden, and W. Kolodziej. 2002. Fish chromatophores as cytosensors in a microscale device: Detection of environmental toxins and bacterial pathogens. *Pigment Cell Res.* 15:19-26.

¹¹ R.R. Preston and P.N. McFadden. 2001. A two-cell biosensor that couples neuronal cells to optically monitored fish chromatophores. *Biosens. Bioelectron.* 16:447-455.

characteristic fluorescence pattern of healthy photosynthetic tissue. Whole cell microorganisms such as *Chlorella vulgaris*, a unicellular green alga, and *Nostoc commune*, a cyanobacterium, have been used to detect nerve agents. Exposure to toxicants causes changes in their characteristic fluorescence induction curves with resultant changes in photochemical yields.¹²

Neuronal tissue is the target of many toxins—specifically, nerve agents—and represents an information-rich source of material for the development of sensing systems. Cultured neuronal networks based on murine spinal cord, frontal cortex, and auditory cortex tissues have been cultured on microelectrode arrays.¹³ The system contains all the metabolic and electrophysiological mechanisms of the parent tissue. The response of the cell can be characterized by recording the extracellular action potentials.¹⁴ This type of system has been shown to detect a wide variety of neuroactive compounds. Laboratory and prototype portable systems have been developed for conducting extracellular recordings of electrically active cells.¹⁵ These systems have the potential to provide some discrimination whereby different cells produce differential response patterns such that an array of different cell types may characterize the toxin to a particular class.

A gene-based optical activity detection system is being developed that measures gene expression and cellular activity of the lung cells with an optical lattice/scaffold arrangement. Lung cells are grown on optical fibers, and spectroscopic signatures of the cells are then monitored.¹⁶ The objective of this approach is to mimic the lung's *in vivo* environment by the utilization of a scaffolding technique so that the responses to toxicants reflect actual events within the organism producing a visual signal.

Conducting *in vitro* assays as a predictor of *in vivo* effects is always subject to challenge. Cells and tissues outside their natural environment can behave quite differently than if they remained in the host. In an attempt to preclude this potential for artifact, investigators are seeking noninvasive, whole organism measurements that may provide information relative to the health of the organism. Continuous noninvasive monitoring of blood chemistry and other metabolic diagnostic indicators are being explored to monitor changes due to toxicant effect on the metabolic processes.¹⁷ Current emphasis is on monitoring the spectral changes in the blood chemistry in veins near the surface of the skin. A remote system for monitoring an individual's health state has been claimed; if this claim is correct, it has the potential to measure blood chemistry and other vital functions noninvasively and to communicate this information via telemetry.¹⁸

¹² C.A. Sanders, M. Rodriguez, Jr., and E. Greenbaum. 2001. Stand-off tissue-based biosensors for the detection of chemical warfare agents using photosynthetic fluorescence induction. *Biosens. Bioelectron.* 16:439-446.

M. Rodriguez, C. Sanders, and E. Greenbaum. 2001. Biosensors for rapid monitoring of primary-source drinking water using naturally occurring photosynthesis. *Biosens. Bioelectron.* 17:843.

¹³ S.I. Morefield, E.W. Keefer, K.D. Chapman, and G.W. Gross. 2000. Drug evaluations using neuronal networks cultured on microelectrode arrays. *Biosens. Bioelectron.* 15:383-396.

A.M. Aravanis, B.D. DeBusschere, A.J. Chruscinski, K.H. Gilchrist, B.K. Kobilka, and G.T. Kovacs. 2001. A genetically engineered cell-based biosensor for functional classification of agents. *Biosens. Bioelectron.* 16:571-577.

J. Pancrazio, P.P. Bey, Jr., D.S. Cuttino, J.K. Kusel, D.A. Borkholder, K.M. Shaffer, G.T.A. Kovacs, and D.A. Stenger. 1998. Portable cell-based biosensor system for toxin detection. *Sensors and Actuators B* 53:179-185.

¹⁴ D.A. Stenger, G.W. Gross, E.W. Keefer, K.M. Shaffer, J.D. Andreadis, W. Ma, and J.J. Pancrazio. 2001. Detection of physiologically active compounds using cell-based biosensors. *Trends in Biotechnology* 19:304-309.

E.W. Keefer, A. Gramowski, and G.W. Gross. 2001. NMDA receptor-dependent periodic oscillations in cultured spinal cord networks. *Journal of Neurophysiology* 86:3030-3042.

B.D. DeBusschere and G.T. Kovacs. 2001. Portable cell-based biosensor system using integrated CMOS cell-cartridges. *Biosens. Bioelectron.* 16:543-556.

¹⁵ DeBusschere and Kovacs, 2001. See note 14 above.

¹⁶ A. Rudolph, DARPA Defense Sciences Office. Presentation to the committee on September 26, 2002.

¹⁷ R. Coifman, I.S. Dalbosco, E.M. Russo, and R.S. Moises. 1999. Specific insulin and proinsulin in normal glucose tolerant first-degree NIDDM patients. *Braz. J. Med. Biol. Res.* 32:67-72.

F. Torella, R. Cowley, M.S. Thorniley, and C.N. McCollum. 2002. Monitoring blood loss with near infrared spectroscopy. *Com. Biochem. Physiol. A Mol. Integr. Physiol.* 132:199-203.

¹⁸ P.D.E. Biggins, C.S. Cox, and K.L. Martin. 2001. Non invasive remote patient monitoring patent. Dstl Report GB01/02450. Wiltshire, U.K.: Defense Science and Technology Laboratory.

RESEARCH ISSUES

For most biological agents of interest, functional systems do not currently have the speed required to meet the detect-to-warn goal of a 1-minute response. Rather, their system response times are on the order of minutes to hours. The reason for this temporal delay is often found in the mechanism of action of the particular toxic agent. While measurable responses in the laboratory can be demonstrated for the various systems, they have yet to be tested under military field conditions. For cell-based assays in their current format, it is likely that existing environmental pollutants in the atmosphere will poison them, and that naturally occurring nonpathogenic microorganisms will break down the sensor cells over time. Similarly, the selectivity, specificity, and sensitivity of the systems have yet to be fully characterized, so that they are not prone to false alarms. These systems, while promising, are still in the prototype stage and hence require skilled specialists to operate them and interpret the data.

Interfacing with Sampling Systems

As already mentioned, cell-based systems are currently in the laboratory and prototype phases, and the issue of how to sample the air and present the collected sample to the cell needs considerable attention. The preparation of the sample for exposure to the cell-based response system will add to the overall system response time. Water sampling systems, though complex, are less challenging than air sampling. DARPA is currently funding an effort to generate a standardized system for water testing that will monitor and/or adjust critical parameters such as pH, temperature, and osmolality.

Operational Deployment

Operational deployment of function-based sensing systems provides some unique challenges. Any system that utilizes living material will have to have an accompanying life support system, unless methods can be developed for lyophilization of the cells and rapid rehydration before use. The complexity of this system will be determined by the element(s) requiring support.

A further challenge arises from the fact that cell-based detection systems may require a sterile environment, depending on the cell type(s) incorporated, if operated in a continuous, reusable mode. However, sterilization of the sample before it is introduced to the cells may in some cases destroy the biological effects one is trying to detect. While this would not affect the ability of function-based systems to detect toxins (unless the toxins are significantly denatured by the sterilization process), it may limit the types of intact organisms that can be detected without additional sample preparation.¹⁹

Conclusion

In summary, with advances in the understanding of cellular processes and how they are inhibited, it should be possible to develop artificial sentinel systems that can detect exposure to a wide range of unknown toxic materials. Currently it is not clear what role these systems may play in a detect-to-warn sensor architecture. Response times so far reported vary from minutes to hours. Detection sensitivities for the systems have yet to be determined, and the targets that are being disrupted in the cellular chemistry need to be elucidated.

FINDINGS AND RECOMMENDATIONS

Finding 9-1: Functional detection systems currently do not have the sensitivities or response times needed for detect-to-warn applications; further, they have not been demonstrated against most of the biological agents. However, they offer considerable potential for filling the gap that is not currently being addressed by specific identifier systems—that is, they could provide a generic detection capability that

¹⁹ The severity of this limitation is not clear. For example, sentinel cells can have a strong reaction to bacterial cell walls, even though the cells themselves have been fragmented by sterilization.

can indicate the presence of unknown toxic agents.

Recommendation 9-1: Research should be conducted to explore how far functional detection systems can progress in satisfying detect-to-warn requirements for low response time, high sensitivity, low false alarm rate, ease of sample preparation, and acceptable logistics for deployment. The research should identify systems that offer a broad spectrum of sensitivities as well as the potential for providing classification of toxic materials. The research should address issues such as sensitivity, false alarm rate, sample preparation, and logistical requirements for deployment.

Finding 9-2: Because of the requirement for sterility when using biological materials as detection elements, function-based detectors that utilize cells and operate continuously may have limitations if intact threat organisms are required for detection.

Recommendation 9-2: Research is needed to explore the limits of cell-based detection systems, including requirements for sample collection and sterilization as well as methodologies for extending the functional life of the sensing elements, both in operation and storage of reagents (cells) for future use. Development of cell lyophilization and rapid rehydration technologies is also needed.

Finding 9-3: The use of sentinel animals has been, and continues to be, an effective method of detection of the introduction of harmful material into a population. The function-based detection system is an extension of this approach that may provide increased sensitivity and decreased detection time.

Recommendation 9-3: Research should be conducted to develop more sophisticated, noninvasive methods (e.g., spectroscopic analysis of blood chemistry close to the skin surface) for detecting rapid biological changes in sentinel animals that result from exposure to a toxic agent.

10

Design Considerations for Detect-to-Warn Defensive Architectures

The design of balanced, effective, and affordable systems for protection against biological aerosol attacks is a complex systems engineering task. The attacker has many biological agents and dispersal mechanisms available. The defender also has a large repertoire of options, although cost and logistical factors may impose limitations. Passive protective features can be incorporated to reduce inherent vulnerabilities and provide the basis for more effective active defenses. Active systems that detect and respond to an attack in progress can utilize protective capabilities that significantly reduce casualties. Technology limitations currently hamper the unambiguous detection and characterization of attacks. However, available systems based on rapid, nonspecific bioaerosol detectors (see Chapter 5) appear capable of timely initiation of meaningful responses in some important scenarios. An incremental deployment strategy for detect-to-warn systems might exploit current defensive opportunities while detection technologies mature sufficiently to provide protection in a wider range of attack scenarios.

This chapter examines architectural concepts for protection of two important target classes against the release of biological aerosols: buildings and extended military installations. A general discussion of the elements that must be considered in system design and the key principles for successful detection provide the context for more specific architectural proposals. The potential effectiveness of facility and distributed site protection systems is illustrated through simplified examples. Strategies are suggested that offer near-term, limited protection of important targets while capabilities are developed to enable more comprehensive defenses in the future. Finally, the committee offers its summary findings and recommendations on the design of defensive architectures.

SYSTEMS ASPECTS OF DEFENSIVE ARCHITECTURAL DESIGN

The overall architecture contributing to defense against biological aerosol attacks will consist of three components:

- Passive and continuously operating systems,
- Detection/Identification systems, and
- Responsive protection systems.

The importance of balancing detection requirements with suitable responses has been introduced in Chapter 2. It is equally important to utilize passive elements where they are cost-effective. Passive defenses are those that are inherent features of the target and include systems that operate continuously

to provide protective effects. For example, HVAC filters and the isolation of internal air circulation zones are important passive elements in facility defenses. In an attack, these systems will reduce agent concentration and slow the movement of contamination throughout the facility. Physical security, including denial of access to the most threatening release points, is another important passive defense element. Some passive defenses can also enhance the capability of active response systems. For example, high-quality filters in a facility may reduce the biological aerosol backgrounds (including particle shedding transients caused by movement of building occupants), permitting nonspecific bioaerosol detectors to employ lower alarm thresholds. The effective isolation capabilities of well-zoned air handling systems also allow longer active defense time lines for the protection of occupants.

Effective detect-to-warn systems will also require a broad range of ancillary systems in support of the detectors. Video and other surveillance systems can provide information on unusual events in the alarm areas and on the status of occupants throughout the facility. Communication and decision support systems can provide situation assessment for the automatic controls and human decision makers who must confirm the alarms and responses. Enhanced HVAC options and perhaps controllable barriers can enable tailored airflow strategies that adapt to specific attack conditions. Communication and control systems can expedite other operational responses such as movement of personnel away from the threat cloud (evacuation or shelter-in-place) or employment of personal protective measures.

Much more systems analysis and process development are needed to define criteria for design of cost-effective defensive systems. Several general guidelines for reducing vulnerability for facility owners currently exist.¹ This general guidance is useful as an orientation to first operational steps for facility protection but does not specify the more detailed process steps that would allow facility owners to complete credible assessments and response plans. Detector-based architectures, even the more straightforward detect-to-treat options, are also beyond the scope of current guidance documents. Because so many of the factors affecting detect-to-warn performance are site specific, effective ways of characterizing the potential for passive defenses and response options for active systems are essential. Criteria for considering and balancing investment in near-term upgrades of passive defenses with more advanced detect-to-treat and detect-to-warn capabilities are needed. These criteria will certainly depend on the function and importance of the protected site. For example, critical military facilities may demand a higher level of both passive and active defense than most civilian infrastructure facilities.

KEY PRINCIPLES FOR DETECTION SYSTEM DESIGN

A number of useful design principles have emerged from the consideration of nominal attack scenarios in light of current and anticipated biodetection capabilities. These have influenced the committee's recommendations on detector development pathways and on strategies for national implementation of detect-to-warn capabilities. These principles are outlined below and are illustrated in the examples discussed in this chapter.

Nonspecific, rapid (less than 1 minute response time) bioaerosol detectors can initiate significant responses for some scenarios.

Some release scenarios create potential detection sites at which agent concentration is much higher than background biological aerosol levels. For example, to attack a large facility, a rapid interior release in one of the rooms of that facility will result in very high local agent concentrations immediately following the release. Under these circumstances, nonspecific bioaerosol or standoff detectors will be able to generate a high-confidence alarm based on the abnormally elevated bioaerosol loading that could be used to initiate medium- to high-regret responses. A thorough assessment of the bioaerosol backgrounds for the defended facility is essential to the development of such a system.

¹ See, for example: Department of Health and Human Services, National Institute for Occupational Safety and Health (NIOSH). 2002. Guidance for protecting building environments from airborne chemical, biological, or radiological attacks. Publication Number 2002-139. May.
W. Blewett. 2001. Protecting buildings and their occupants from airborne hazards. U.S. Army Corps of Engineers Technical Instruction. Available at <http://securebuildings.lbl.gov>. Accessed August 2003.

Rapid (e.g., 1- to 5-minute response time) identification detectors will remain essential for more sophisticated threats. Low-level, extended-duration attacks that do not yield actionable alarms from nonspecific detectors must be addressed by detectors that employ more specific identification technologies. Many low-level releases that provide bioaerosol loadings near background levels can result in infective doses to unprotected personnel in a matter of minutes. For these attacks, continuously running identification detectors may be required to serve both the detection and identification functions simultaneously. Identification detectors will also be used to verify the initial alarms from nonspecific detectors and to expand the response if a biological attack is confirmed.

The committee focused on detectors that might achieve identification of biological agents in 2 minutes or less as the baseline performance requirement for the study. Such rapid identification will enable effective detect-to-warn responses for a wide range of scenarios. Initial analyses also indicate that significant benefits might be achieved even for somewhat slower detection time lines (e.g., 5 to 10 minutes) in some scenarios. Further analysis is needed to understand how predicted casualties decline in various scenarios as detection time lines drop from current levels of 25-30 minutes to the 2 minutes or less range postulated by the committee. Detection systems matched to available response options will yield the best performance.

Many different levels of response to biological detection alarms are often available for implementation in a specific defended site or facility. As discussed in Chapter 2, the highest level of protection can be achieved by the earliest initiation of protective responses consistent with the certainty of attack indicators. This principle can be implemented with a multistage detection architecture in which the fastest detectors are backed up by more sensitive and specific sampler-identifier systems.

Many other sources of information are available to the defense to supplement biological alarms from detectors. Some of these can be by-products of the detectors. For example, standoff detectors may be able to characterize the shape of the threatening biological cloud to determine whether it resulted from a deliberate release. The combination of reports from a network of detectors can also provide backup information to verify the reports from a single detector as well as spatial data on agent dispersion. Other types of information developed by sources beyond the detectors may be useful in verifying an attack. For example, the number of people or specific activities (e.g., cleaning) in a region of a facility may be correlated to biological backgrounds in that area. Inclusion of this factor into the decision algorithms that determine response to nonspecific detector alarms may allow use of adaptive threshold levels that better recognize attacks while minimizing false alarm rates. Integration of multiple, disparate sources of information is vital in characterizing potential biological attack events.

FACILITY PROTECTION ARCHITECTURES

Enclosed facilities are important targets and deserve special consideration for detect-to-warn protection. They may be the targets of choice of less sophisticated attackers since the required quantity of agent and the level of agent weaponization are reduced. A relatively inefficient dispersal mechanism may also be adequate. Facilities are also important owing to both their symbolic importance and, often, their vital military or political functions.

Facilities offer unique opportunities for significant detect-to-warn protection of their occupants. The fundamental defensive concept examined in this section centers on reduction of agent dispersion within a facility through the use of passive facility modifications as well as active, detection-based responses. Approaches suggested here will not assure protection for all occupants of a facility in the event of an attack. For example, if a release occurs in one room or region of a facility, detection and responses can be initiated in an attempt to reduce exposures throughout the facility. Unfortunately, such responses are unlikely to protect occupants from the very high agent concentrations near the release point.

However, for other building occupants, a number of factors can intervene to reduce the likelihood of infection. Normal transport delays, dilution in the HVAC system, and isolation of major air handling zones limit the rate of concentration buildup at points away from the release area. Active air handling responses to improve these natural mitigating factors include shutdown or redirection of airflows toward the release

area. Other effective responses include evacuation of building occupants along uncontaminated routes and use of temporary personal protection measures during the response or evacuation. In the case of outdoor attacks, the sheltering effects of facilities, perhaps enhanced by active response to enhance isolation, can play important protective roles.

Because facilities and their associated air handling systems and other response options span such a broad spectrum, it is impossible to identify detection requirements that will be universally applicable. Site-specific facility characteristics will have a dominant impact on requirements and resulting effectiveness of all defensive concepts. A thorough countermeasure analysis will also be required to determine whether unique site vulnerabilities might compromise the operation of a defensive system under consideration.

The nature of airflow characteristics within a facility is one of the most critical factors that influence the vulnerability of the facility to attack and the effectiveness of potential defenses. These issues will be discussed in the next section, followed by an example that illustrates the behavior of one hypothetical building.

Time Line and Zone Isolation Considerations

The transport of agent from the release point to other parts of a facility is primarily the result of pressure-driven flows induced by air handling fans. Other pressure-driven flows, particularly external winds acting through exterior openings, may exist. Flows induced by temperature differentials may also be important in some interior spaces. While these diverse flow drivers will ultimately result in a broad distribution of the agent within the facility, there are significant time delays and reductions in agent concentration in the process. Proper air handler responses can significantly increase these protective factors.

Examination of the time lines and losses associated with agent transport processes can inform questions regarding detector response requirements. The transport of an interior release consists of a series of steps. These include:

- Mixing within the immediate region (or room) where the release occurs.
- Intrazonal transport to the other rooms or regions supplied by the air handling unit in the release zone.
- Interzonal transport, including exchange across zone boundaries that spreads agent to adjacent air handling zones.

Specific times associated with each of these steps will depend on the operational status of the air handlers at the time of the attack as well as the layout, ductwork, and physical barriers associated with the facility and the HVAC system. Since the flow of biological agents has a great deal in common with other types of vapors and aerosols, much of the literature regarding indoor air quality applies to consideration of these areas. Unfortunately, the dominance of site-specific factors places severe limitations on the ability to provide broadly applicable insights into transport rates. However, some general observations followed by a nominal example may be useful.

The time delays associated with mixing in the immediate room or region of the release will depend upon the internal air currents within that region and the overall air exchange rate driven by the HVAC fans. Some results indicate that the time constant for aerosol mixing in a room following a rapid point release is on the order of 2 minutes.² This means that a concentration buildup at return ducts in a release area may allow detection at that point within 1 to 2 minutes. Experimental studies on aerosol dispersion in laboratory rooms have identified some of the factors that account for uncertainties in the delay time and spatial distribution of the agent in the region and have recommended detector deployment locations.³

² J.J. Whicker, P.T. Wasiolek, and R.A. Tavani. 2002. Influence of room geometry and ventilation rate on airflow and aerosol dispersion: Implications for worker protection. *Health Physics* 82:52-63.

³ J.J. Whicker, J.C. Rodgers, C.I. Fairchild, R.C. Scripsick, and R.C. Lopez. 1999. Evaluation of continuous air monitor placement

Placement of detectors closer to potential release points can reduce time delay and increase the concentration of agent at the detectors, but it risks poor response times for releases that are placed away from the detectors. Tracer and modeling studies of the behavior of releases within areas of concern can assist in the analysis of site-specific flow patterns and the designation of detector deployment locations.

The rate at which contamination spreads from the release area to other areas within the same HVAC zone depends on both the rate of air exchange and losses due to agent deposition in the ductwork and filters of the HVAC system. The dilution due to mixing from nonrelease regions and the cleaning caused by HVAC filters can be reasonably well predicted. However, these effects will depend on the HVAC operational status (localized temperature conditions, fresh air fraction, air exchange rate, and so forth) at the time of the attack.

Transport of the agent across HVAC zone boundaries is quite difficult to predict. It is dependent on the design, operation, and isolation of each air handling zone as well as many other effects such as external temperature and wind conditions. In large open spaces served by several air handling units, there may be minimal independence and isolation of the flows between units. Furthermore, particularly in facilities with connected air spaces, the imbalance of widely separated air handling units (i.e., some units operating with excess supply and others with excess exhaust) can create net driven flows across wide areas. Many other uncertainties that are difficult to characterize and model can create very wide bounds on interzonal transport.⁴ The problems associated with the analysis and modeling of agent transport in large open spaces such as exist in convention centers, sports arenas, and airports are particularly difficult. These have been studied in some detail⁵ although the prediction of flows is so complex that empirical methods may be the best alternative for applied defensive system design.

Pressure-driven flows caused by external winds may also be important in determining both intra- and interzonal transport conditions in a facility. These flows are a function of many variables, including the inherent tightness of the building, status of building openings (i.e., doors and windows), direction and intensity of the wind, and the air handler operating conditions. As a result, the characterization and analysis of the impact of such flows on defensive responses involving airflow control can be complex. In some facilities, these factors may be so significant that they preclude the possibility of predictable, defensive airflows being set up by the air handlers in response to an attack.

An example that postulates a release inside a multizone office building is included in the following section to illustrate defensive concepts and the approximate time lines and agent concentrations resulting from a nominal attack scenario. While this example does not represent any particular building, the parameters used in the simplified model are representative of a modern office building designed with attention to airflow control and vulnerability reduction.

Example: Attack on a Multizone Office Building

A biological agent is assumed to be released into a single office in an office building served by three air handling units. The total volume in the facility is assumed to be approximately 3,000 m³. In this simple, illustrative example, each of three air handling zones in the facility is of equal size and the release room is assumed to comprise 10 percent of the release air handling zone (3.33 percent of the total facility). For the baseline scenario, an attacker releases enough dry anthrax powder of appropriate size to provide one hundred times the median infectious dose (assuming a 5-minute exposure interval) if the agent were instantaneously spread throughout the entire facility. The median effective dose for anthrax is assumed to be 8,000 spores, as shown on the plot of probability of infection versus dose (commonly called the probit curve) in Figure 10.1. The actual amount of powdered material required for the baseline

in a plutonium facility. *Health Physics* 72:734-743.

Whicker et al., 2002. See note 2 above.

⁴ M.D. Sohan, R.G. Sextro, A.J. Gadgil, and J.M. Daisey, 2002. Responding to sudden pollutant releases in office buildings: 1. Framework and analysis tools. Lawrence Berkeley National Laboratory, Report LBNL-47446. April.

⁵ A.J. Gadgil, 2000. Pollutant transport and dispersion in large indoor spaces: A status report for the large space effort of the interiors project. Lawrence Berkeley National Laboratory, Report LBNL-44791. June.

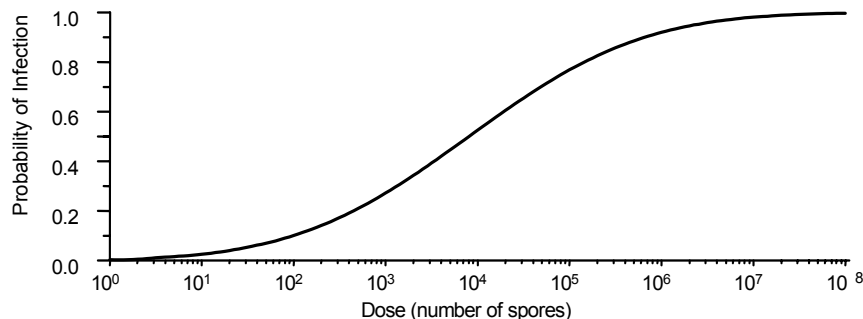

FIGURE 10.1 Probability of infection versus dose for inhalation anthrax.

release will depend on the efficiency of the release mechanism. For a perfectly efficient dispersal scheme (an impossible task even for sophisticated attackers), the release amount would be about 0.1 to 0.2 grams of high-quality anthrax powder. For more realistic release efficiencies, the amount required would be proportionately higher. Other cases for which the effective release quantities are much larger are also considered below. The agent is assumed to be released over a period of 5 minutes. If a more infectious agent were to be released (see Table 2.1), then the number of particles required for an effective attack would be smaller.

The nature of the assumed flows is diagrammed in Figure 10.2. The agent is released in the release room. The other rooms in the air handling zone where the agent is released are designated as zone A1. The adjacent air handling zone is designated A2 and the final zone, A3. The air exchange rate between rooms within a single zone is determined solely by the air handler rate of 4 air exchanges per hour. Interzonal airflow is modeled as an equivalent air exchange rate of 0.4 air exchanges per hour with the adjacent zones. This value is not atypical of the rate that can be achieved in modern office buildings with well-designed HVAC systems.⁶

For this example, the only fresh air input is through the air handler inlets with no infiltration or

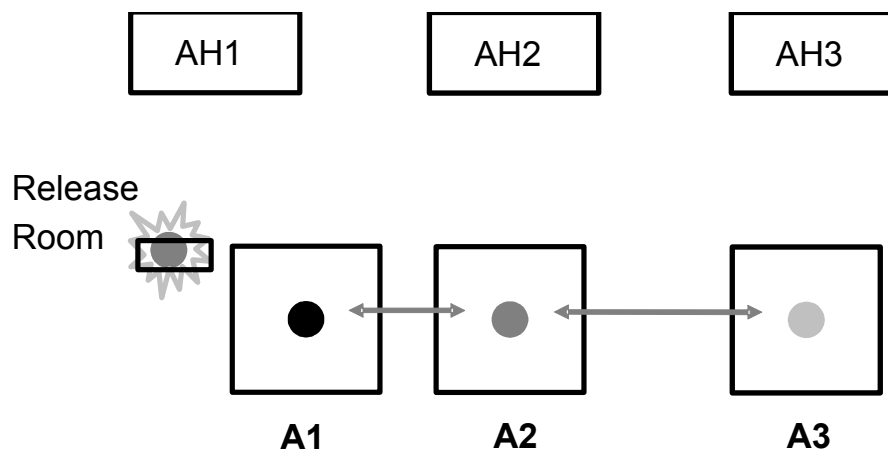

FIGURE 10.2 Airflows in the multizone office building.

⁶ See, for example, the case study in Sohan et al., 2002. See note 4 above.

exfiltration of outside air through doors, windows, cracks, or other openings. For tight buildings, where infiltration and exfiltration effects might result in the equivalent of only 0.1 to 0.2 air changes per hour, this simplification is reasonable. However, there are many buildings for which these effects will have a much larger impact on intra- and interzonal transport and therefore would need to be considered in the analysis. For the cases discussed, 90 percent air recirculation through the HVAC air handlers and 98 percent HVAC filter efficiency are assumed. This filter efficiency is representative of filters currently installed in some modern infrastructure facilities (e.g., airport terminals) where interior isolation from outdoor pollutants is desired.

Agent concentration levels within the facility when no changes in air handler operation are initiated following the release are shown in Figures 10.3 and 10.4. Concentrations in the release area, in the air handler plenum for zone A1, and in other offices in zones A1, A2, and A3 are plotted. The concentration in the A1 air handler is calculated for the plenum upstream of the filters.

Figure 10.3 shows the long-term (about 200-minute) change in the relative particle concentration in the release room, other rooms in the release zone, and the other two air handlers in the building. Following an initial buildup, the long decline in concentration is due to the impact of filtration and make-up fresh air. It is notable that equilibration and reduction in concentrations to relatively safe levels takes several hours. The early time contours shown in Figure 10.4 show the wide differences in concentration in the various zones for the time intervals of interest for biodetection and response. For times in the 3- to 5-minute range, which would be reasonable for rapid detection and response using nonspecific detectors, the difference in concentrations between the release room and the adjacent air handler zones is quite significant. For example, at about 5 minutes following the release time, there is a five orders of magnitude difference between the release room and the adjacent zone and another two orders of magnitude drop in the third air handling zone. These can be viewed as protective factors that are gradually reduced over time as the agent is dispersed throughout the facility. The protective effect of filtration and good interzonal isolation of airflows in a facility can be quite significant.

The agent concentrations in the release room and in the return plenum of the A1 air handling unit (as shown in Figures 10.3 and 10.4) are expected to be well above biological aerosol backgrounds, particularly for facilities that employ good filtration and other design features to reduce background levels. (For a more extensive discussion of the determinants of biological backgrounds, see Chapter 3.) If this conjecture is verified by long-term background data from facilities of interest, then the use of nonspecific detection for initiation of medium- or even high-regret responses with low false alarm rates appears possible. Nonspecific detection from detectors in other rooms of zone A1 is not as promising due to reductions in agent concentration caused by the air-handler

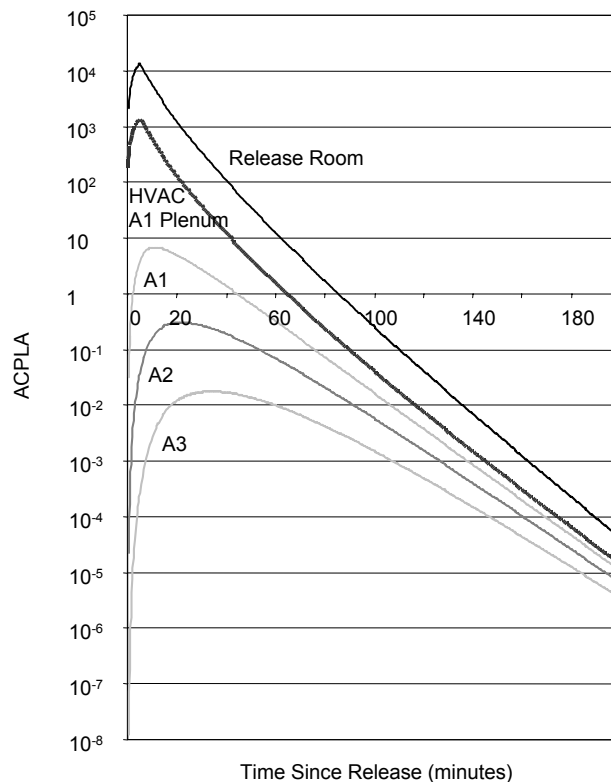

FIGURE 10.3 Anthrax concentrations for baseline release scenario, with no HVAC response.

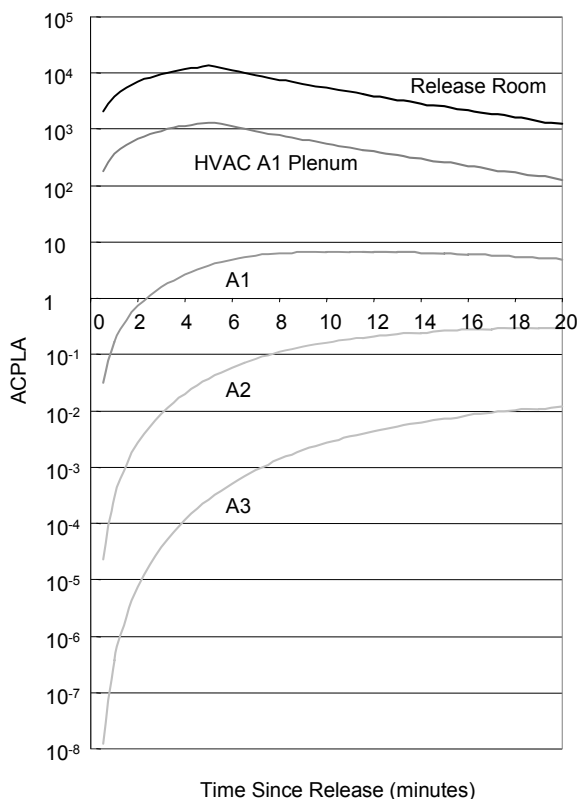

FIGURE 10.4 Early time anthrax concentrations, with no HVAC response.

shutdown are shown in Figure 10.5. It is assumed that the occupants of the facility are unwarned and do not respond to the event. The solid curves show the increase in probability of infection when no HVAC response occurs. The lower, dashed lines indicate the reduction in probability of infection for HVAC system shutdown at 3 minutes following the release. These infectivity estimates are based on the probit curve shown in Figure 10.1. It is notable that the isolation of air handling zones and the effects of good filtration provide a significant benefit to the occupants of the facility away from the release room even in the absence of any protective responses. These benefits are due to a slower buildup of agent in air handling zones away from the release zone, which allows a significant time for a protective response to be mounted.

The probability of infection 90 minutes after the attack is 0.67, 0.36, and 0.12 in zones A1, A2, and A3, respectively, if no air handling response occurs and if occupants remain stationary (Figure 10.5). For the HVAC system shutdown response at 3 minutes, it is assumed that flows from the release room to A1 are halted and that interzonal flows are reduced from the assumed baseline level of 0.4 air changes per hour to 0.1 air changes per hour. One might imagine even more effective interzonal strategies if positive differential pressures were established in adjacent zones, causing a net flow back into the release zone to force a more rapid exhaust of the agent out of the release zone.

An attacker can reduce the time available for response and increase the threat in remote air handling zones by increasing the size of the attack. Larger attacks result in a greater amount of agent being transported to adjacent zones in the early stages of the attack, before response can be initiated by detection systems. The probability of infection for the unwarned (no HVAC or other response) case is also increased. The unwarned probabilities of infection for releases that are 10 and 100 times baseline level are shown in Figure 10.6. Even for the much larger attack sizes, the buildup of agent in the adjacent zones is still reasonably slow.

filters. Hence, if detectors cannot be proliferated in rooms throughout the facility, the best deployment locations appear to be in the return plenums of the air handlers. Since site-specific factors determine both background levels and the intra- and interzonal flow characteristics of facilities, it will be important to measure long-term background levels as well as the airflow characteristics during the design of defensive systems. Note also that the curves in Figures 10.3 and 10.4 assume instantaneous mixing in the release region. In reality, there will likely be a several minute delay due to local mixing processes before these levels are observed in the release room return ducts or air handler plenum. In other cases, such as a release into the return duct to the air handler, the intra-zonal dispersion of the agent throughout the air handling unit will begin almost immediately. This condition might create more favorable conditions for detection of an attack by sensors in the air handling unit but might also reduce the effectiveness of airflow controls in isolating other rooms or other air handling zones to reduce agent speed.

Estimates for the probability of infection of occupants in the various zones for the baseline scenario with no HVAC response and HVAC

Figure 10.7 shows the increase in probability of infection over time in zone A2 for different attack sizes. Even at 10 minutes, the probability of infection in A2 for the 100x baseline case is approximately .53, significantly below the final unwarned level of .85. This slow change in infectivity even in the face of large changes in attack size is largely the result of the highly nonlinear probit curve. Because infectivity rises slowly with increase in attack size, responses in the few (1 to 5) minute range will have significant value, even for very large attacks. A sound understanding of the basis for current probit slope assumptions will be required before defensive system performance requirements can be specified with high confidence.

The impacts of different responses on the probabilities of infection for several attack sizes are summarized in Figure 10.8. For each bar representing a specific attack size and air handling zone, the top level represents the probability of infection for an unwarned population (no HVAC or other protective response). The next level reflects the reduction due to a shutdown of the HVAC 3 minutes after the attack. The lowest bar represents infectivity levels resulting from HVAC system shutdown at 3 minutes, followed by evacuation of the occupants of the facility into uncontaminated air 10 minutes later. Particularly for the remote air handling zone (A3), early shutdown appears to provide the most important contributions to reduction in probability of infection.

It is important to note that the larger attack sizes postulated in the 10x and 100x scenarios will result in very high biological aerosol loadings in the release room and in the air handler in zone A1. These levels would be so high above background that nonspecific detectors in the air handling unit of the release zone would likely provide a rapid and unambiguous alarm. For such releases, current bioaerosol detection technologies may be able to provide the basis for the most responsive shutdown and evacuation response, shown in Figure 10.8.

The nominal parameters used in this example demonstrate the potential for active detection and defense in a modern facility. The assumed flow values do not represent the measured response of any particular facility. Such low interzonal flow rates may not be present in most current facilities but are not unreasonable for modern HVAC system designs in buildings constructed with interzonal isolation in mind. More complete architectural studies and empirical assessments of the performance of real facilities are needed to fully assess the promise of these concepts.

Impact of Facility Design on Defensive System Effectiveness

Investments in facility and HVAC protective features can have a major impact on the passive vulnerability of a facility to biological attack. A balance must be sought between improvement of passive elements of facility defense and the active systems that respond to attacks. While a detailed exposition of these issues was beyond the scope of committee deliberations, several factors that bear on the performance of facility defenses are reviewed here.

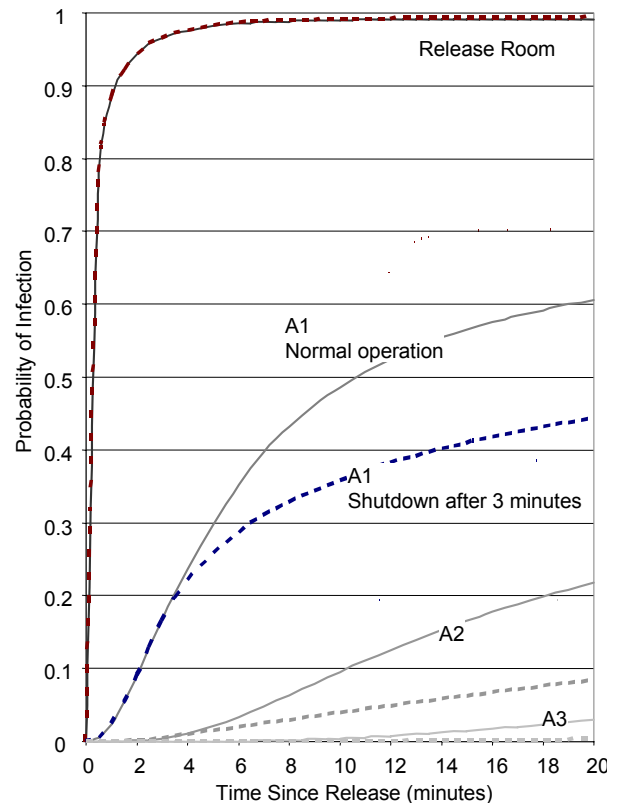

FIGURE 10.5 Probability of infection for unwarned, with no HVAC response, and with HVAC shutdown response.

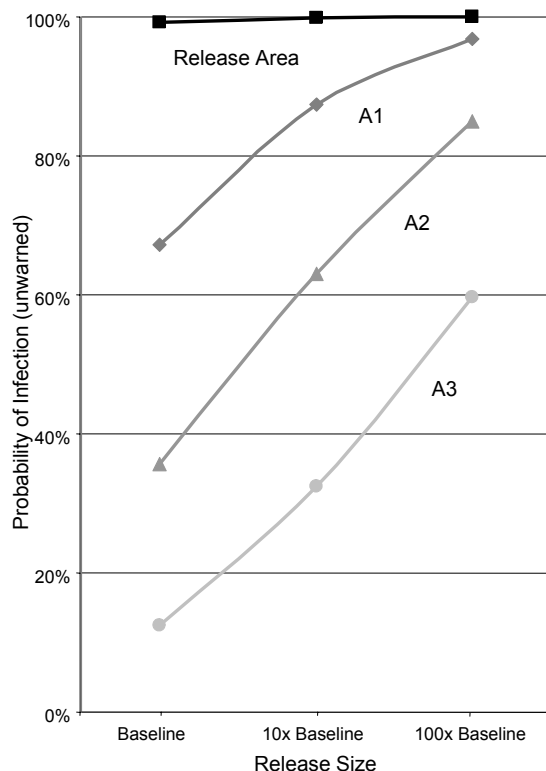

FIGURE 10.6 Probabilities of infection for larger releases, with no response.

tracer tests and air velocity instrumentation in airport terminals have measured flows that would transport agent rapidly through several air handling zones.⁷ Flow velocities up to 1 to 2 meters per second have been observed in corridors where restricted flow paths exist between large-volume facilities. In cases such as these, reduction in interzonal flows is one of the most important defensive measures that can be implemented.

Provisions to reduce interzonal airflows are relatively easy to incorporate in new construction. Assuring that ductwork from several zones is not intermixed, that zones are physically separate where possible, and that flows driven by exterior openings are minimized are useful steps. The balancing of air-handler fans is perhaps the most important vulnerability reduction step that owners of existing facilities can take. Each isolated zone should be operated to equalize supply and return flows to minimize the pressure-driven flows toward or away from that zone. Other changes that increase interzonal isolation, such as separation of ductwork in adjacent zones or physical barriers to block flow from adjacent zones can be retrofitted into existing facilities, although costs may be prohibitively high.

Filters and Other Background Reduction Measures

High-quality filters can have a significant impact on the concentration of biological agents that are transported through the air handling systems. Filters with average removal efficiencies of about 98 percent for biological aerosols over the anticipated sizes of interest are currently being installed in airports⁸ and other modern facilities for air quality reasons. Even more effective filters are under

Air Handling Zone Isolation as a Fundamental Strategy

The isolation of independent air handling zones to reduce transport of released agents is a fundamental defensive element in facility protection. If large, pressure-driven airflows mix the released agent rapidly across many air handling zones throughout the facility, the potential for reduction of casualties is significantly reduced. There are many ways in which this facility-wide mixing can occur. In extended open spaces, large drift flows can result from imbalance of air handlers serving widely separated regions or by external wind effects through doors, windows, or other openings. The intermingling of ductwork from two different air handling zones can greatly increase the rate of mixing. Finally, thermal effects can create significant mixing flows, particularly in open atrium areas exposed to sunlight through windows and in open vertical spaces of multistory buildings.

Major pressure-driven drift flows in large interconnected spaces have been observed in real facilities. For example,

⁷ D.M. Edwards. 2002. Tracer release experiments at San Francisco International Airport to improve preparedness against chemical and biological terrorism. Sandia National Laboratories, Report SAND2001-8380. June.

⁸ Edwards, 2002. See note 7 above.

development, although higher operating costs and shorter replacement intervals are expected for these systems. Other more innovative filtering and air cleaning measures are currently under research. (See Chapter 3 for a more extensive discussion of air cleaning alternatives.)

The added benefits of filtering and other air cleaning technologies for protection against biological attack should be considered as a factor in decisions that relate to the quality of filters installed in new or existing facilities.⁹ In light of the growing perceived threat of biological attack, such considerations might justify larger investments in more effective filtration. When active defenses are planned for a facility, the potential added benefit of reduced biological backgrounds that enable enhanced detector performance should also be considered in the review of filtering options.

Implementation of Facility Defensive Features

Many performance trade-offs must be faced in the implementation of defensive systems in existing facilities and new construction. Analysis of the diversity and uncertainty in current and future threats must underlie design processes. Guidance for system design, including performance and cost-effectiveness criteria, could be developed and coordinated with facility owners and appropriate government oversight agencies. For existing facilities, approaches to tailor operational plans to site-specific constraints could be formulated. Security procedures should be reviewed for preventing unauthorized individuals from having access to locations vulnerable to agent release. Assessment and characterization processes to identify vulnerabilities and potential response options are needed. Incorporation of defensive features into building designs before construction will enable inclusion of passive and active defensive provisions at the lowest cost. Standards and processes for the design of new construction to reduce vulnerabilities and permit straightforward incorporation of active defenses, either at the time of construction or later, should be provided to architects and developers.¹⁰ Implementation must also consider the impact on performance of long-term system maintenance and personnel issues. Such factors as air-handler balancing, filter system maintenance, and facility changes that affect zonal flow isolation can dramatically impact the performance of a defensive system. Where system response depends on the intervention of a skilled operator, the effects of training and other human factors can also be very significant.

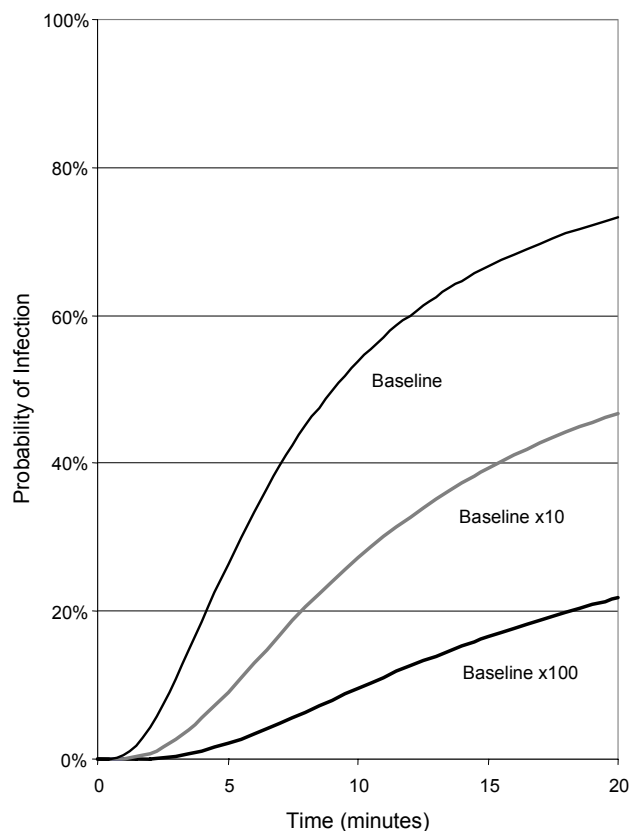

FIGURE 10.7 Probability of infection versus time (zone A2) for larger releases.

⁹ T.L. Thatcher and J.M. Daisey. 1999. Reducing mortality from terrorist releases of chemical and biological agents: 1. Filtration for ventilation systems in commercial buildings. Lawrence Berkeley National Laboratory, Report LBNL-44350.

¹⁰ The committee notes that these programs would likely have considerable overlap with efforts to protect the occupants of buildings from clouds of radioactive material.

Other Facility Detection System Considerations

In the above example, the defense exploits locally high concentrations resulting from a relatively rapid release of an agent interior to the facility. However, there are other tactics that might be employed by a more sophisticated attacker to reduce the nonspecific signature of the attack. One is a slow release or trickle attack in which very small amounts of agent are released at an interior point over a long period of time. A second is the release at an exterior inlet for one or more air handling units.

Low-Level Attack Scenarios

Very slow releases can cause gradual buildup of agent so that concentrations remain near background levels throughout the facility. Mounting such an attack could take many hours and will require a more advanced dispersal system that can effectively dispense agent at a slow, controlled rate. The attacker also faces the prospect that slower, more sensitive detectors and samplers that collect large air volumes will discover the release in time to take defensive action to disrupt the release. Finally, since the concentration builds up gradually across the facility, a small number of relatively slow, high-sensitivity collectors and detectors may be adequate to discover the attack in its early phases.

Releases at exterior inlets to the air handling system will also create significant bioaerosol loadings in the air handler if the release period is short. Concentrations at the inlet duct may be comparable to those resulting from interior releases if the air handlers are operating in a mode that recirculates a significant fraction of the uncontaminated interior air. For trickle releases at the air handler inlet, the detection and defense problems are expected to be comparable to similar slow releases at other interior locations.

Much more detailed analysis is needed to assess the range of potential attack scenarios and resulting demands on the biological detection architecture. It appears that the ability to implement continuous, highly sensitive identification detectors to protect against low-level attacks may be a requirement for robust facility defense. However, the response times needed to defend against such low-level releases are expected to be much less stringent than those required for the higher release rates considered earlier.

Distributed Detection Architectures

If detectors could be made cheap enough and reliable enough, one would ideally like to spread them throughout a facility, much as smoke detectors are used today. This would offer several potential performance advantages for detection architectures. Detection sensitivity requirements for distributed detectors can be somewhat lower than for detectors centralized in the air-handler units. This is because

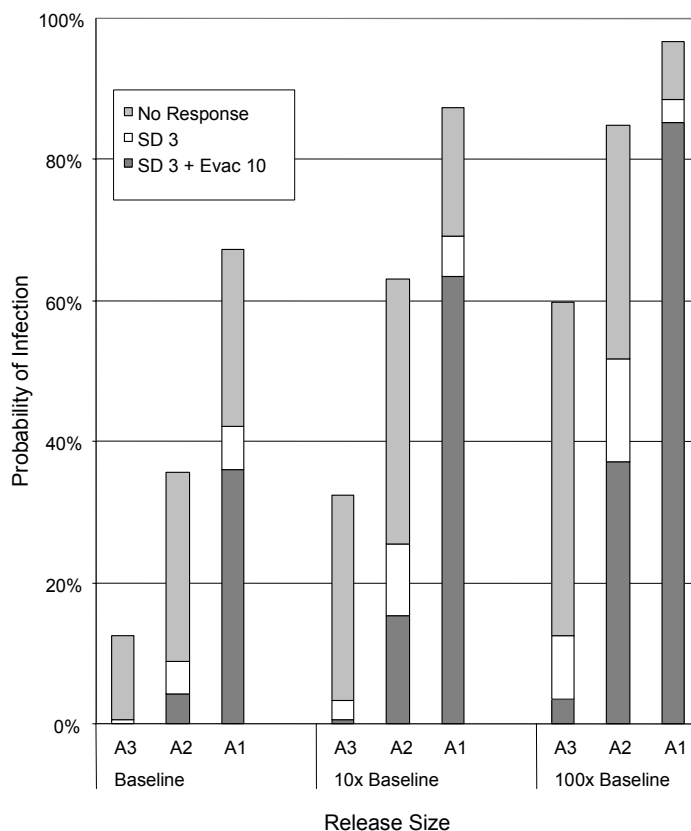

FIGURE 10.8 Probability of infection for various release sizes and response options. (SD3, HVAC system shutdown at 3 minutes.)

detectors placed near the release will see the high local concentrations associated with that release as well as a more rapid change in biological background away from baseline levels. By contrast, the agents entering the air-handler plenum are diluted with uncontaminated return air from the nonrelease areas of the air-handling zone, increasing the sensitivity requirements of the detectors. Compared to distributed detection assets placed near the release, somewhat greater time delays will be experienced by the centralized detectors, associated with the flow of return air to the air handler and a slower rate of change in agent concentration buildup. One disadvantage is that the greater number of detectors in a distributed system could result in more false alarms. However, this effect might be offset by the ability to set higher detection thresholds in a distributed system to reduce the false positive rate per detector. Furthermore, adjacent detectors could provide overlapping coverage that will assist in ascertaining false alarms and other single-detector malfunctions.

The operating conditions of the air handling system will also impact the relative requirements and advantages of a distributed and centralized architecture. For example, when recirculation is low (fresh air fraction high), the detection sensitivity requirements on a detector in an air handling unit may be quite high owing to the large dilution factor caused by mixing of both fresh air and air from uncontaminated interior regions. This dilution due to fresh air mixing would not affect the concentration profile observed by distributed detectors in the release area.

Confirmation of initial distributed alarms with more centrally located identification assets will remain important for the foreseeable future. Hence, this distributed concept would not avert the need for multistage detection capability.

Facility Protection—Strategies and Priorities

A national strategy for protection of critical military and domestic facilities must balance the need for near-term implementation of systems that have constrained capabilities with the competing need for more extensive research, development, and demonstration of systems that can counter a broad range of biological attacks. A phased strategy that simultaneously deploys initial defensive systems in critical facilities and accelerates research on the most promising technologies for augmentation of these defenses could be the best path forward. A well-designed, modular approach to multistage detection and response architectures could allow for incremental improvements that would result in effective facility protection upgrades within 2 to 5 years. The key elements of a strategy that could be implemented in several phases are outlined below.

- *Phase 1 priorities.* The use of currently available, nonspecific aerosol detectors to activate facility responses can significantly reduce casualties for some scenarios if facility passive and HVAC systems are designed and operated with this goal in mind. Initial implementation steps must include processes to characterize, analyze, and modify the facility systems essential for the protective response. Deployment of fast-acting detectors, probably in the air handlers initially, will provide triggers for environmental sample collection and perhaps other low-regret actions. Bioaerosol levels far above background might also provide a sufficient basis for higher-regret alarms. The foundation for defense against low-level and other sophisticated attacks will continue to be detect-to-treat sampling and laboratory analysis in this phase of deployment. A more complete understanding of background levels and variability and how they are affected by site-specific factors is essential for successful deployment of these nonspecific detection elements. More extensive analyses of the architectural concepts and the design bases for near-term systems are needed before commitment to widespread deployments.
- *Phase 2 priorities.* The ability to confirm attacks at the facility rather than wait for the several hour (or longer) confirmation from an outside laboratory is an important augmentation of the initial deployment concept. If such confirmation can be achieved within 15-20 minutes, more significant HVAC and other responses can be taken to the nonspecific alarms since there is the capability to resolve the uncertain alarm and restore the facility to normal operations in a relatively short period

of time.

- *Phase 3 priorities.* The ability to achieve rapid and sensitive identification of low agent concentrations is important for defense against low-level releases and other sophisticated attacks. In the most demanding of these scenarios, bioaerosol detectors may be of limited value, so initial alarms would need to be generated by continuously running identification detectors. It is expected that confirmation response times of 1 to 5 minutes will permit timely initiation of the complete response spectrum, minimizing the number of casualties. Somewhat longer response times (e.g., 5 to 10 minutes) might also be very useful in some facilities.
- *Phase 4 priorities.* Extension of detection capabilities to permit low cost, specific detectors (biological smoke alarms) to be distributed throughout the facility will both improve system performance and make defensive systems affordable for a much broader range of facilities. The performance improvement results from placement of sensors closer to potential release points, causing a reduction in response time and enhanced ability to detect smaller attacks. The improvement in situation assessment afforded by integrating responses from a network of detectors may also be significant.

It is important to note that the committee addressed the full range of aerosol releases in both exterior and interior attacks in response to the guidance of the sponsor. The Phase 1 and Phase 2 systems provide for coverage against moderate to large-scale attacks, and the Phase 3 system extends the defense to small-scale releases and even trickle attacks within facilities. The effect of the diverse array of agents available to the attacker was also considered. Hence, the committee believes that a major portion of the threat space for aerosol attacks on fixed sites and enclosed facilities has been addressed. The high-level concepts of operation and examples included in the report provided a set of general insights that guided the technical consideration of detector performance, which was the primary focus of the committee's tasking. The capabilities of the proposed defensive architectures relative to variations in the specific attack characteristics (agent type, release size, release conditions) would require more detailed analysis of not only the detectors and their supporting systems but also the available operational responses and site-specific factors. While a more complete understanding of these sensitivities will be important in the engineering of defensive systems, the level of analysis pursued by the committee is seen as adequate to recommend technical development directions, as specified by the statement of task.

DISTRIBUTED TARGET DEFENSIVE ARCHITECTURES

Protection of distributed target complexes against biological attack is a high-priority goal for military planners. These targets include posts, air bases, and naval ports in the continental United States and abroad, airports and seaports of debarkation (A/SPODs), and deployed naval forces. This section addresses a military base containing both exposed personnel and facilities to represent this class of targets. Such bases are often surrounded by a buffer zone where physical security is tight. Outside that zone, an attacker has broad latitude to pursue either airborne or ground releases. Quite sophisticated attacks are assumed possible, including line releases of weaponized agent.

An attacker faces many decisions in the mounting of a line attack against a distributed target. One important decision is whether to generate the line release close to the target complex or further back from the secured area. The closest possible release that will allow cloud development will usually provide the most certain and efficient coverage of the target complex. More distant releases run the risk of misdirection and cloud breakup due to uncertain meteorological conditions with a resulting reduction of dose levels on the targeted site. However, under ideal conditions and with a sufficiently large release quantity, a more distant release could allow the cloud to expand, resulting in very long exposures at relatively low concentration levels as it passes over the target complex.

The size of a line release attack will depend upon the target elements that the attacker wishes to hold at risk. A minimal release might be sized to threaten primarily exposed personnel. However, since many personnel will be occupying base facilities, particularly in the early morning hours when

meteorological conditions are most favorable for the attacker, it would seem likely that the attack would be sized to yield high confidence infection of both exposed personnel and occupants of base facilities. In this case, the intensity of the attack would need to be sufficient to overcome any sheltering capability of the facilities. Smaller point releases that attempt to target a portion of the base or avoid detection assets are possible but run the risk that unpredictable meteorological conditions could alter the trajectory of the released cloud.

Detection Architecture Options

A detection system consisting of multistage spectroscopic point detectors deployed at the boundary of the buffer zone is assumed as the baseline defense. As in the case of facility defenses, the rapid, nonspecific element of the detection system can initiate identification processes and, if biological aerosol loading is far enough above background, higher impact responsive measures. For low-level attacks, rapid identification detection may be necessary to initiate response action. Attacks that employ broad, low concentration clouds make detection difficult for the defense. This case is analogous to the trickle release scenario against facility defenses.

Standoff detectors might be employed to detect the cloud as it approaches the boundaries of the buffer zone.¹¹ Since standoff systems will have the capability of scanning the horizon, they can yield information on the structure of the approaching cloud that might help distinguish purposeful releases from natural phenomena.

Responses to detection of a threatening cloud could involve a range of actions. Some low-regret possibilities exist, particularly to improve the sheltering capabilities for base facilities in the path of the cloud. One might imagine a network that links base buildings and initiates operations to close outside openings and control internal airflows. Higher-regret measures might involve the use of personal protective gear for exposed personnel (and perhaps facility occupants as well) or sheltering strategies that move personnel to the least vulnerable nearby building. More effective responses can be incorporated into facilities to make them much less vulnerable to passing clouds if sufficient warning is available. For example, an independent air handling system using highly filtered air could establish positive pressure in the defended facility. Some of the facility defensive measures discussed in the previous section might apply here as well. For exposed personnel outdoors and away from the potential sheltering capabilities of nearby facilities, there are few low-regret response options in the absence of personal protective gear.

An example illustrating a nominal outdoor attack on a distributed target complex is described in the following section. The parameters are chosen to represent a sizable and sophisticated attack. A facility with characteristics similar to the one examined in the earlier example is used to illustrate the potential of protective, shelter-in-place strategies.

Example: Attack on an Extended Military Installation

An attack on a military base is assumed to be executed by a sophisticated adversary employing an aircraft flying upwind of the target and releasing dry, weaponized anthrax. The release is 4 km upwind of the perimeter of the base and utilizes 50 kg of anthrax (approximately one trillion times the LD₅₀ of anthrax) dispersed 100 feet above the ground. Dispersal efficiency is assumed to be 20 percent. Very favorable meteorological conditions, including a 5 meter per second wind, result in a well-formed, uniform cloud being carried toward the target area. The concentration contours near ground level (1 meter) at the time the center of the cloud first reaches the defended perimeter (12 minutes following the start of the release) are shown in Figure 10.9. As the cloud passes over the target area, it creates a sizable zone (almost 35 km in depth) in which the probability of infection to exposed personnel is approximately 0.7.

¹¹ Operational issues for standoff detection systems (for example, the extent to which UV lidar can be used effectively during daylight hours) are discussed in Chapter 5.

This footprint is illustrated in Figure 10.10. The assumed line release is along the Y axis ($X = 0$ km) and extends for 10 km from $Y = 0$ to $Y = 10$ km. The cloud encounters the perimeter of the base at $X = 4$ km.

The agent concentrations at ground level as the cloud passes over the defended perimeter are low relative to those noted in the interior facility release. Current bioaerosol detectors using thresholds low enough to detect this attack would likely experience relatively high false alarm rates. Hence, any action initiated based solely on bioaerosol alarms would necessarily be low-regret. Networking of multiple detectors deployed in the defended area could reduce false alarm rates by providing additional alarms that could be assessed for consistency with possible release environments.

The potential benefits of standoff detection can be illustrated by considering the vertical contours of the cloud. These contours at the midpoint of the line release ($Y = 5$ km) are shown in Figures 10.11 and 10.12 for 6 and 12 minutes following the release, respectively. The most generic benefit from a standoff system operating at the perimeter of the defended area

is the increased time allowed for response to detection. At the 5 meter per second wind speed assumed in this example, each kilometer of standoff allows over 3 minutes of increased response time. The standoff detector also has a chance to exploit aspects of the release cloud that are denied the stationary spectroscopic point detector. For example, in the cloud described by Figures 10.9, 10.10, and 10.11, a standoff detector could presumably view the leading edge of the cloud, which lies well above ground

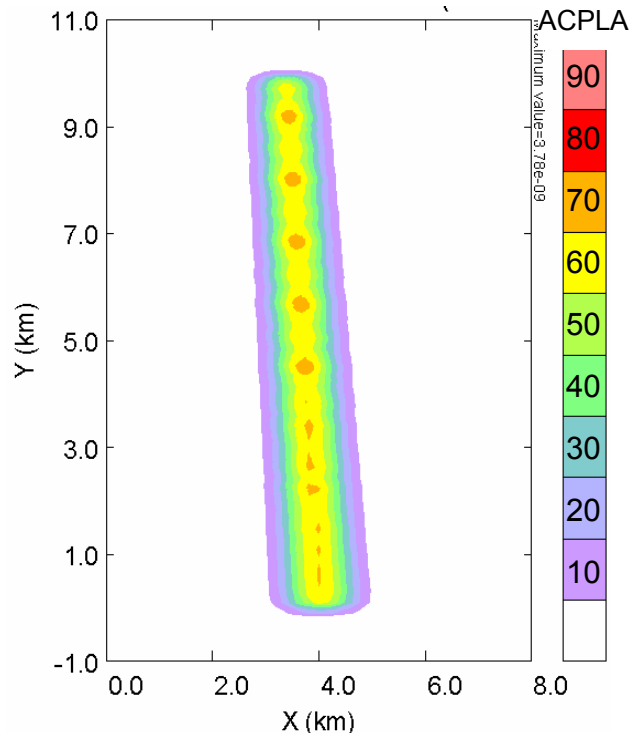

FIGURE 10.9 Agent concentrations at base perimeter.

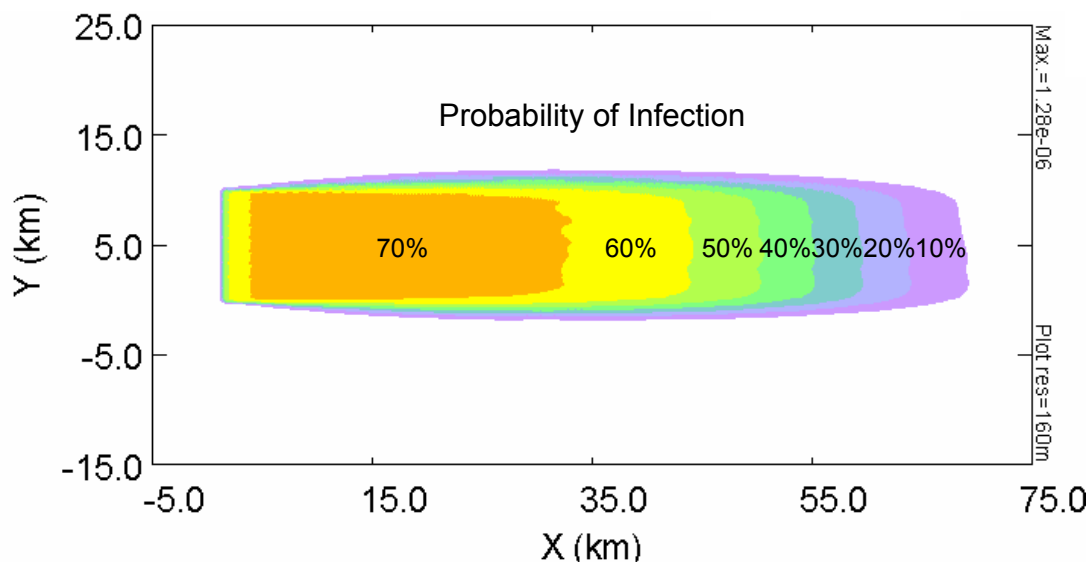

FIGURE 10.10 Infectivity contours for exposed, unprotected personnel.

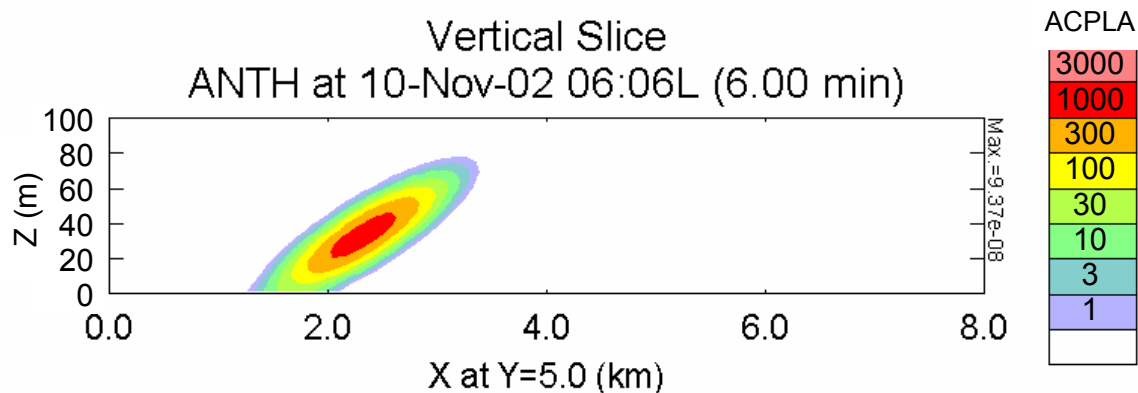

FIGURE 10.11 Concentration contours 6 minutes after the release.

level, to achieve even earlier warning. For clouds released near the perimeter, the standoff detection system might scan to detect the highest concentration level to differentiate an attack event from normal background. In the current example, the maximum concentration point does not occur at ground level where a stationary point sensor might measure it. Finally, a scanning standoff system might be able to recognize the uniform structure of a recently dispersed agent cloud.

Consideration of the protective effect of a building in the path of the cloud illustrates the importance of facility-related responses as an element of the defense against these attacks. A facility very much like the nominal office building examined in the previous section of this report is assumed placed within the defended area. The building has a filter efficiency of 98 percent and an air handler that produces 4 air changes per hour with 90 percent recirculation. (This is equivalent to 0.4 fresh air changes per hour and 3.6 recirculated air changes per hour.) The nominal infiltration rate is assumed to be 0.1 air changes per hour, which reflects, as discussed earlier, a well-isolated, modern building design.

For such a building operating in steady state (i.e., no airflow response to the attack), one can define a dose reduction factor that is the ratio of the dose a person inside the building would experience to the dose that an outdoor, unprotected person would be exposed to. Use of a simple single-compartment model of the building¹² yields an estimate of 0.014 for the dose reduction factor in this case. This means

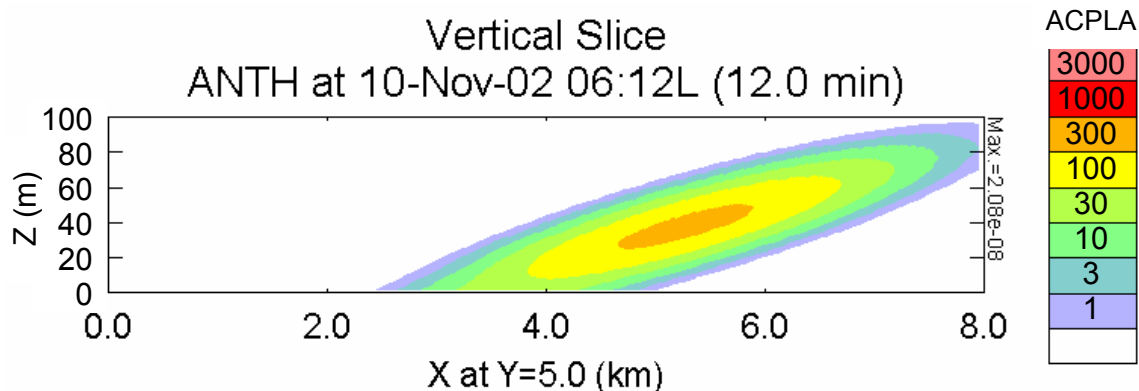

FIGURE 10.12 Concentration contours 12 minutes after the release.

¹² L.L. Yuan. 2000. Sheltering effects of buildings from biological weapons. *Science and Global Security* 8:329-355.

that a person who stays inside the building will receive a total dose of 1.4 percent of the dose that would be received by a person standing outdoors through the passage of the cloud. The resulting infectivity contours for the current release scenario are shown in Figure 10.13. Even though the dose levels are reduced by almost two orders of magnitude, an infectivity level of 20 percent is predicted. Note that this is due to the relatively flat probit slope assumed for anthrax infection.

Greater protection of facility occupants might be achieved if certain low-regret facility options could be activated as the agent cloud approaches. Some improvement is possible by shutting down the air intakes for the HVAC systems. This is particularly the case if the systems are operating initially with a high fresh air fraction. However, the most effective approach would be to reduce the air infiltration into the building. This infiltration comes from a variety of sources including doors, windows, cracks, and other openings and is driven by a variety of means, including pressure-driven flows from the air handlers, external winds, and thermal effects.

Creation of a positive-pressure interior environment can reduce this infiltration to very low levels but requires a clean air supply and specialized air handler operations. In the absence of systems to reduce infiltration, some improvement in infectivity levels can be achieved by shutting down air intakes upon warning of agent cloud approach and moving building occupants outside after the cloud has passed. Figure 10.14 shows that the outdoor concentration level drops below the interior level about 15 minutes after the cloud first hits the building. The curves in Figure 10.15 compare infectivity levels for nonresponsive facility operations (infiltration = 0.4 ac/hr) with a strategy that includes initial closing of HVAC intakes (infiltration = 0.1 ac/hr) along with evacuation of occupants outdoors when concentrations drop below interior levels. The data shown indicate that the improvements resulting from this strategy are significant, particularly when the sheltering characteristics of the facility are good (i.e., a low infiltration rate). However, this strategy may be difficult to implement, since it requires the measurement and comparison of relatively low indoor and outdoor concentrations at the end of the attack.

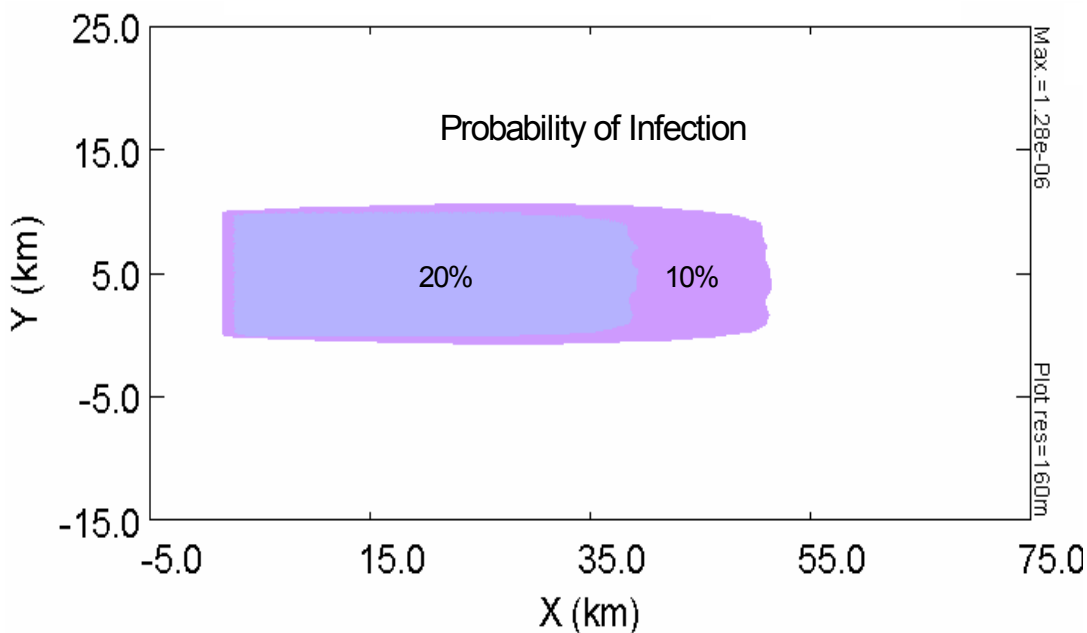

FIGURE 10.13 Infectivity contours for a building dose reduction factor of 0.014.

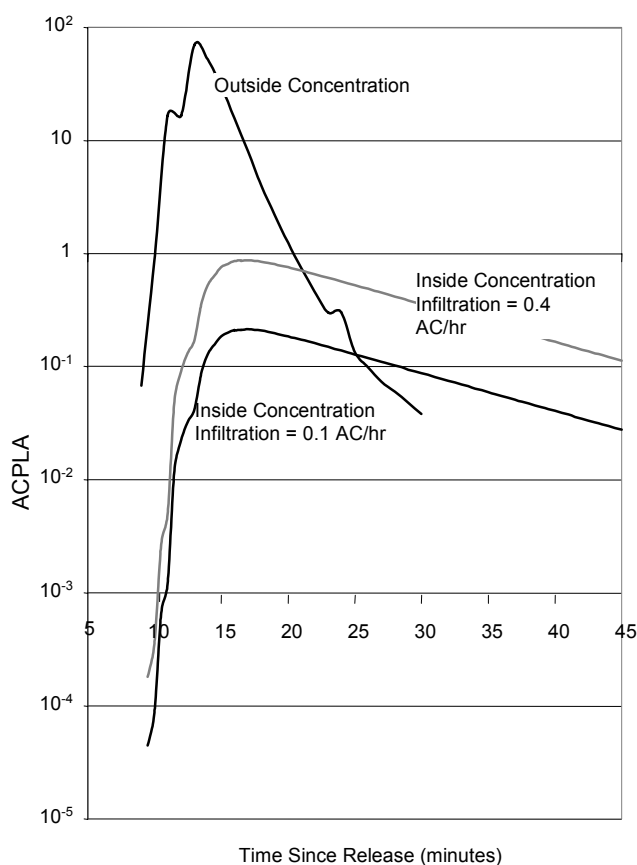

FIGURE 10.14 Outside and interior concentrations for targeted facility. This is the base case with no response.

that implements near-term protection focused on detect-to-treat responses is already a part of the DoD chemical and biological defense program. Augmentation of these initiatives to add near-term detect-to-warn elements and broadening them to include a few key domestic complexes could be appropriate initial steps toward development of more widespread capabilities.

The philosophy underlying this strategy is similar to that recommended for facility protection. Available bioaerosol detectors deployed as close as possible to the release point can trigger identification detectors and might initiate other response actions for very large attacks that increase bioaerosol levels well above background. This triggering function is already employed in existing military systems to initiate agent identification. Exploitation of these same nonspecific detections, particularly in initiation of low-regret facility responses, could yield significant protective benefits. The capability of facilities to provide intrinsic protection, and even greater isolation if active air handling and isolation responses are employed, should be an important defensive consideration in these types of scenarios. The potential for standoff detection of higher-level releases also deserves examination as an independent source of early information on an approaching agent cloud. As was the case for facility protection, effective defense for the broad range of scenarios will require rapid, sensitive identification detectors for low-level attacks. These considerations lead to a phased R&D and deployment strategy. Priorities associated with the key elements of this strategy are outlined below.

While there is no sharp knee, or inflection point, in the curve, it is clear that 1- to 2-minute warning times provide significantly greater reduction in casualties than do 5- to 10-minute warning times. Therefore, a 1- to 2-minute warning has been the committee's focus. For nonspecific bioaerosol detectors, the committee believes this can be done with a reasonable signal-to-noise and hence low false alarm rate for moderate to large attacks on the facility, since the number of agent particles will far exceed ambient background particles. However, if a threshold for still smaller attacks is set, there will be more false positives if only a nonspecific detector is used. Therefore, the committee proposes adding a rapid identifier (2 minutes or less) to deal with the potential of smaller, or trickle, attacks while still providing a 2-minute or shorter warning for maximum casualty reduction.

Distributed Target Protection— Strategies and Priorities

Distributed target complexes, particularly military bases in the continental United States or abroad, are a high priority for implementation of biological defense systems. A strategy

Phase 1 Priorities

The use of bioaerosol detectors at the perimeter of the defended area to trigger confirmation of the attack and perhaps to initiate low-regret responses for high-intensity clouds provides a basis for initial detect-to-warn capabilities. However, development of protective response options may be equally important. For early deployments, this will likely involve improvements in facilities in the defended area to increase their effectiveness as shelters against the passing cloud. Some of these measures will also assist in the protection of the facilities against interior or air intake attacks. For critical military sites, attack confirmation may be accomplished in a 25-30 minute window using current multistage detection systems (e.g., JBPDS). Less critical military or domestic targets could employ collected samples processed in a remote lab for attack confirmation. This slower confirmation cycle could limit the intensity of the initial responses to bioaerosol detection alarms. A more thorough examination of defensive architecture trade-offs and concepts of operation are required for these architectures, partly because of the greater detection ambiguity expected for low-threshold bioaerosol alarms in outdoor scenarios.

Phase 2 Priorities

The improvement of standoff detection technologies may offer significant enhancements in the nonspecific detection of approaching clouds. Further investigation and development of a concept of operations that would allow exploitation of both concentration and cloud structure information are needed.

Phase 3 Priorities

Full detect-to-warn capabilities against low-level attacks will require rapid, continuously operating, sensitive identification and confirmation detectors similar to those targeted in the third phase of the facility protection strategy. However, in the case of distributed complexes, the time lines available for the corresponding functions are somewhat relaxed due to the transit time of the cloud from the perimeter of the defended area to key target elements of concern.

FINDINGS AND RECOMMENDATIONS

The committee's specific findings and recommendations for detect-to-warn defenses of facilities and distributed military installations are detailed below.

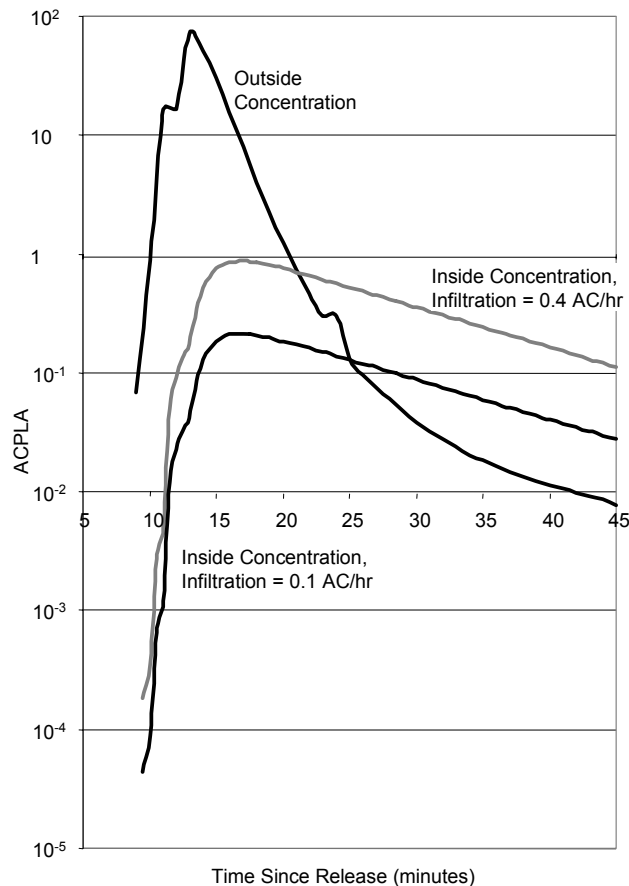

FIGURE 10.15 Probability of infection of facility occupants for responsive and baseline cases; ac/hr is air changes per hour.

Defense of Facilities

Facility protection systems appear to offer opportunities for the application of both near-term and emerging detection technologies to achieve significant protection against biological attacks. The principal findings and recommendations in this area are as follows:

Finding 10-1: For rapid releases of biological agents into facilities, nonspecific bioaerosol detectors may offer reliable warning with relatively low false alarm rates in many attack scenarios of interest. Such unambiguous detection can occur when agent concentration well above background levels is created in the area of the release.

Recommendation 10-1: Nonspecific, bioaerosol detectors should be deployed in a diverse set of facilities to understand the performance of these detectors in interior spaces. The frequency and cause of false alarms should be investigated. Concurrent data on biological backgrounds in the facilities should be acquired to provide a basis for the assessment of long-term performance and design of robust defensive systems.

Finding 10-2: More sensitive and specific identification detectors have a role in facility defense architectures. They provide on-site confirmation of nonspecific alarms via a separate and independent detection technology. They can also provide the added sensitivity needed for detection of extended duration, low-level, interior releases. Response times on the order of 1 minute are highly desirable, although benefits may accrue to somewhat slower detectors in some scenarios.

Recommendation 10-2: Research should be continued in the most promising detection technologies that offer promise of rapid, specific identifiers. Perform a more complete analysis of representative scenarios and facilities to characterize the dependence of overall defensive system effectiveness on sensor response times.

Finding 10-3: In the longer term, widespread deployment of a network of low-cost, reliable detectors (biological smoke alarms) within a facility offers important advantages, including rapid response to releases and lower false alarm rates.

Recommendation 10-3: Research should continue to identify promising concepts for very low cost distributed detectors.

Finding 10-4: The ability to isolate HVAC zones, the quality of building filters, and other operational factors that determine airflows within a facility are critical determinants of inherent vulnerability and the ability to respond to warning of an attack. These features are highly site-specific and, in general, must be characterized empirically. Some facilities may require upgrades in airflow control and other response options before active defense can be implemented effectively.

Recommendation 10-4: Methodologies for analyzing facility vulnerabilities and characterizing airflow control and other responsive options should be developed.

Finding 10-5: Improvements in passive protection features of a facility (e.g., isolation of air handling zones, upgrading of filters) can reduce vulnerabilities and must be balanced against investment in active defenses. Design of a balanced detect-to-warn architecture is a complex systems engineering task.

Recommendation 10-5: Design studies leading to a methodology and criteria to guide facility investments in active and passive defenses should be pursued. A dialogue concerning appropriate baseline threat and protection levels should begin as a part of national homeland security initiatives.

Finding 10-6: Many facility design features that offer the potential for the most effective defensive responses can best be incorporated early in the planning process for new facilities.

Recommendation 10-6: Programs should be initiated that will modify architectural standards to incorporate the benefits of reduced vulnerability to biological attack as an integral part of the design process for new facilities.

Defense of Distributed Military Installations

Defense of distributed target complexes (e.g., military installations) against outdoor attacks can be addressed using some of the same principles that were applied to facilities. The task is made more difficult, however, by a more demanding detection environment and by the absence of effective low-regret response options, particularly for exposed personnel. Several specific findings and recommendations that apply to this scenario follow:

Finding 10-7: For outdoors releases, agent concentrations relative to backgrounds are often much lower than in facility scenarios. This reduces the ability of nonspecific, bioaerosol detectors to initiate responses and increases the importance of rapid (i.e., 1- to 5-minute), continuously running identification technologies. Such specific identifiers are likely to be required for all but the largest of outdoor releases.

Recommendation 10-7: Rapid, specific detection technology should be pursued as a baseline for outdoor detect-to-warn defenses.

Finding 10-8: Standoff detection systems, if effective, could significantly enhance installation defense architectures through their ability to provide earlier warning, to sense areas of highest agent concentration, and to characterize spatial features of the threat cloud.

Recommendation 10-8: A concept of operations for standoff detectors should be pursued that integrates realistic standoff data with other detectors and an installation defensive system.

Finding 10-9: The use of installation buildings in a sheltering and isolation role may provide the most effective means to respond to attacks on military bases and similar target complexes.

Recommendation 10-9: Cost-effective response options for improving the shelter-in-place capabilities of installation buildings should be explored, including cutoffs for air handling system intakes; reduction in the infiltration rate of outside air; and separate, highly filtered air supply systems.

General Recommendations

Two additional areas that were found to impact all defensive architectures were deemed noteworthy. Specific findings and recommendations in these areas are as follows:

Finding 10-10: The characteristics of biological aerosol backgrounds have a critical impact on the performance of detection systems, particularly those that employ nonspecific detectors for response initiation.

Recommendation 10-10: A more comprehensive program to characterize backgrounds in both interior and exterior environments should be initiated. This program should be conducted in conjunction with deployments of detectors in order to link background features to false alarm characteristics of candidate detection systems.

Finding 10-11: Achievement of very good performance in detect-to-warn systems (i.e., with less than 10 percent infectivity) can be a particularly demanding challenge. With current probit curve models of infection, very low concentrations of agent are required to achieve such a low level of infectivity.

Recommendation 10-11: The validity of widely used infectivity models should be reviewed before applying those models to generate defense system requirements.

11

Summary of Conclusions and a Path Forward

Each previous chapter in this report concludes with findings and recommendations relating to the individual technologies and detection strategies discussed in that chapter. This final chapter begins by summarizing the main conclusions reached by the committee about the individual technologies. It then attempts to synthesize the committee's best judgment into a plausible series of steps toward the goal of practical, effective detect-to-warn systems for the scenarios considered in this report. The chapter concludes with the committee's overall findings and recommendations regarding this path forward.

DETECTION AND IDENTIFICATION SYSTEMS

Advances in detect-to-warn systems have the potential to reduce significantly the casualties associated with bioterrorism attacks on both indoor and outdoor targets, ranging from individual high-value buildings to extended military bases. Such warning, if provided rapidly enough (in less than 3 to 5 minutes, depending on the scenario), will enable a range of protective options, from turning off HVAC systems to sheltering in place to facility evacuation in the case of an interior release.

The committee considered two types of biosensors for detect-to-warn systems: (1) nonspecific detectors with a rapid response time and (2) specific identifiers with a somewhat slower response time. Both types of biosensors are viewed as having important roles to play in an integrated detect-to-warn sensor architecture.

Nonspecific Detectors

Nonspecific detectors respond to bioaerosol particles present in the air at concentrations higher than their detection threshold. They offer a rapid response but provide little information about the nature of the particles detected (hazardous or nonhazardous; alive or dead; type of biothreat agent). Two kinds of nonspecific detectors are discussed in this report: standoff detectors and spectroscopic point detectors. The committee's major conclusions about these detectors are summarized below.

Standoff Detectors

Standoff detection uses electromagnetic radiation to detect the threat agents at a distance. Most of the work to date has focused on the use of lasers either to detect the presence of an aerosol cloud at distances of tens of kilometers or to ascertain whether the cloud has a biological or nonbiological content, at distances of several kilometers. This work has the potential to provide the earliest possible warning for

extended targets such as military bases, but more work is needed to better understand just how such systems would be used (i.e., the concept of operations). Provided that robust concepts of operations can be formulated, the development of a hybrid infrared-ultraviolet (IR/UV) standoff biodetection capability should be expedited.

In addition to these nonspecific detection techniques, the Department of Defense has also recently begun to investigate advanced standoff techniques—ranging from ultraviolet resonant Raman scattering to passive infrared detection—in the hope of providing either longer ranges or more specific identification. These are still in the early research stage. More convincing laboratory data to support modeling projection of detection ranges and ability to discriminate against expected backgrounds is needed before considering any acceleration of these efforts.

Spectroscopic Point Detectors

Spectroscopic point detectors typically measure some properties of the suspended aerosol at the detector itself rather than at some standoff distance. Some of the simplest spectroscopic sensors use particle counting with size discrimination to detect a sudden increase in aerosol concentration in the sizes of interest. Although this information is accurate and rapid, normal fluctuations in particles within the 1- to 30-micrometer diameter range can result in an unacceptable level of false alarms. Also, because an aerosolized biological agent can produce morbidity and mortality in exposed personnel even when its concentration is very low (even lower than that of nonpathogenic microbes), nonspecific spectroscopic point detectors cannot protect personnel against such low-level attacks.

A more capable spectroscopic point detector uses an ultraviolet laser to excite the tryptophan, reduced nicotinamide adenine dinucleotide (NADH), and flavin fluorescences that are characteristic of biological materials and uses the time rate of change of the signal to differentiate a rapid bio warfare agent release from the more gradual fluctuations of the natural background. The false alarm rates of these bioaerosol detectors are a function of the detection threshold and the ambient bioaerosol background. When operated outdoors and at modest sensitivities (tens of ACPLA) they currently exhibit false alarm rates of between one and tens per day. Their false alarm rates in filtered indoor environments and for the 10^2 to 10^4 ACPLA levels discussed above may be dramatically lower. This would depend on the size and nature of fluctuations in the level of nonpathogenic microbes as a result of human or other activity in the indoor environment. Research on the inclusion and exploitation of additional spectroscopic signature information should reduce this false alarm rate even further. Therefore, the committee considers bioaerosol detectors to be the most promising near-term candidates for the 1-minute, nonspecific detection portion of the system.

Specific Detection and Identification Technologies

Four potential methods of identification are discussed that can provide specific information on what type of biological organism or toxin may be present in a sampled bioaerosol cloud: nucleic acid sequence-based detection; molecular recognition of identifying structures on the surface of the organism or toxin; unique chemical attributes of the organism or toxin; and biological responses to the organism or toxin. The committee's conclusions regarding these identification approaches are summarized below.

Sequence-Based Detection

Sequence-based detection uses the genetic information contained in a pathogen's DNA or RNA to detect and identify the pathogen. In laboratory studies, such techniques have shown the best sensitivities (detecting as few as 5 cells) and very low false alarm rates (about 10^{-5} for a single signature and lower for multiple signatures). Typical analysis times range from 15 to 60 minutes. The key issue for detect-to-warn applications is the extent to which this sensitivity and specificity must be sacrificed in moving to the demanding detect-to-warn time lines of less than 5 minutes and preferably of 1 minute or so. The

committee noted that a 1-minute detection time means 1 minute for the total process: sample collection, sample preparation, detection, and subsequent analyses.

For techniques that amplify the genetic material (e.g., PCR) and hence require sufficient time for multiple amplification cycles, the committee did not see any way of meeting the 1 minute time requirement. However, research groups around the world are pursuing integrated PCR systems for identification in under 5 minutes. The committee believes that the probability of such prototype systems being realized within the next few years is relatively high. The committee is also relatively confident that by developing rapid, automated sample preparation and handling techniques and by reducing the number of amplification cycles, it should be possible to perform a single-target, real-time PCR assay within 3 minutes, starting with the collection of an aerosol sample. There are no data that would permit an extrapolation of such a system to estimate the time requirements of a deeply multiplexed (e.g., 15 target sequences) PCR assay with any confidence.

Because repeated amplification cycles take time, one is led to consider unamplified detection. The most promising of these techniques is the detection of ribosomal RNA (rRNA), which exists in multiple copies in each cell (about 10,000 copies per cell is typical for bacteria). Achieving 1-minute detection will require significant research and development of rapid, automated sampling techniques that remove assay inhibitors, lyse the target cells, and transfer their content to the detector. Even if the research and development effort is successful, such an RNA assay would not carry the same information content as a full identification using DNA.

Structure-Based Detection

Structure-based detection uses molecular recognition processes to detect the characteristic shapes and functional group distribution of biomolecules on the surface of pathogens or of toxins. Typically this molecular recognition is achieved using antibodies in a multistep immunoassay. Today, such assays take on the order of 15 minutes, have detection thresholds of 10^3 to 10^5 particles per milliliter of solution, and exhibit false positive alarm rates on the order of 10^{-3} . However, significant improvements in response times, detection thresholds, and false positive rates should be possible. Current response times are limited by the time it takes to transport the antigen to the molecular recognition site and not by the antibody-antigen binding time, which takes seconds or less. Improved detection techniques that get around some of the noise issues in current approaches promise lower detection thresholds.

Because structure-based detection techniques detect molecules on the surface of pathogens, they have simpler sample preparation requirements than do sequence-based techniques. The committee believes that with sufficient research and development to overcome the mass transport issues, 1-minute structure-based identification should be achievable.

The other significant issue is that of false positives. Two factors contribute to the false positive rate. One is insufficient specificity and the other is nonspecific binding. There are promising paths for addressing both factors, including the use of multiple signatures instead of one. Given that 2-minute detection has already been demonstrated and that there are reasonable approaches for attaining very low false alarm rates, the structure-based detector is the committee's leading candidate for a 1- to 2-minute identifier. The trade-offs between fixed-surface and solution-based assays need to be examined.

Chemical-Based Detection

Chemical-based detection techniques use molecular characteristics (e.g., size, mass) or chemical composition rather than biological activity to detect biomolecules. Biomolecules of interest include proteins, their peptide subunits, lipids, carbohydrates, and the small molecules involved in the everyday functioning of biological agents. The best known of these techniques uses mass spectrometry to fingerprint bioagents—that is, to match the mass patterns from an unknown sample to the mass patterns in a library of known samples. There has been considerable progress in this area, especially for time-of-flight mass spectrometry (TOF MS). However, the critical issue for these biomarker approaches is how

well they will work in complex mixtures of naturally occurring microorganisms and other background components.

Another possible approach for rapid identification of pathogens would involve the use of small, low-cost, semiselective sensors, but very little work has been done in this area and off-the-shelf solutions are not available. It is not known if the performance of these semiselective sensors will meet detection requirements (signal-to-noise ratio, sensitivity, minimal false positives). An unacceptable number of false positives is expected if these semiselective sensors are operated independently; however, the use of networked sensor arrays would likely improve accuracy.

Function-Based Detection

Functional-based detectors use organisms, whole cells, or parts of cells to detect the biological activity of agents. As such they are less specific than sequence- or structure-based techniques but have the potential for detecting unknown chemical and biological agents. Initial research has focused mainly on chemical intoxicants and has only recently begun to explore applicability to biological warfare agents. At present, detection times for truly functional systems are tens of minutes to hours, much too slow for detect-to-warn applications. While some of these times might be reduced with additional research, other times are limited by the physiological response time of the organism or cell to that particular family of agents and so will not likely be improved. Therefore, for at least the next 5 years, these systems seem best suited to be sentinels for exposure to a wide range of unknown toxic materials rather than detect-to-warn sensors with response times of 1 minute. It can be expected that cell-based detectors will be attacked by naturally occurring, nonpathogenic microbes, so removal and replacement will be a critical issue, as will the rate of false positives.

Effectiveness of Detection and Identification Systems

Spectroscopic bioaerosol detectors will be able to detect, but not identify, all biological agents (known or unknown; natural or engineered) as long as they contain proteins. Techniques based on nucleic acid sequences can, in principle, detect and identify all the bacteria and viruses listed in Table 1.1 except the toxins, because these do not contain genetic material.¹ In practice, any fielded sequence-based instrument will have signatures for a few to a few tens of agents and will only be able to detect these agents.

Structure-based recognition systems can, in principle, detect and identify not only all the agents listed in Table 1.1 but other agents as well, provided the agent is known and a recognition element (e.g., an immunoassay) has been developed for it. In practice, any fielded instrument will have signatures for a few tens of agents and will only be able to detect these agents.

Chemistry-based techniques have the greatest potential to serve as rapid, inexpensive sensors required for the distributed biological smoke alarm concept. However, individually these detectors are generally semiselective—that is, they would respond not only to biological agents but also to other molecules and organisms with common characteristics, and this would lead to high false alarm rates. Achieving greater selectivity may require using a collection of such sensors with different chemically interactive surfaces.

The function-based techniques are the only ones capable of detecting unknown or unanticipated agents (natural or engineered, biological or chemical), though they are unlikely to be able to identify the specific agents. This class of techniques detects chemical and toxin agents by their activity. For the foreseeable future, these function-based techniques are likely to be too slow for warning purposes and will be most useful in detect-to-treat applications.

¹ Nucleic acid-based systems may detect residual DNA in formulations that use toxin agents as weapons unless the formulations have been highly purified.

DETECT-TO-WARN SYSTEMS FOR BUILDINGS AND EXTENDED MILITARY INSTALLATIONS

While the detect-to-warn architectures for both indoor and outdoor targets draw on a similar technology base, differences in characteristic target and attack parameters require that the technologies be used differently in these two scenarios. Below, the committee summarizes its conclusions about the indoor release scenario, from detection of bioaerosols inside building airspaces to a phased defense implementation strategy. The committee then explores the protection of extended military installations from outdoor releases of bioagents and examines how differences in these scenarios lead to modifications in the recommended implementation strategy (Figures 11.1 and 11.2).

The focus of the scenarios considered in this report has been covert attacks on facilities or installations. Various environmental and operational features of conflict or restoration operations will impact the requirements and performance of the detection systems considered here. However, the effects can be in opposing directions. For example, a conflict environment may complicate the environmental background against which the signal must be detected but, on the other hand, it may increase the readiness of response systems, increase the number of surveillance assets available, or perhaps allow greater tolerance of false alarms. Many of these operational and response issues are beyond the scope of the current study. The bioaerosol and particulate background associated with various operational states is of interest. As noted, the committee found only limited data on even normal environment backgrounds. No data that represented measured or analyzed wartime environments were discovered.

These data would be of interest and worthy of inclusion in the report, but their impact on the recommendations would probably not be very large. Various proven techniques exist for filtering or

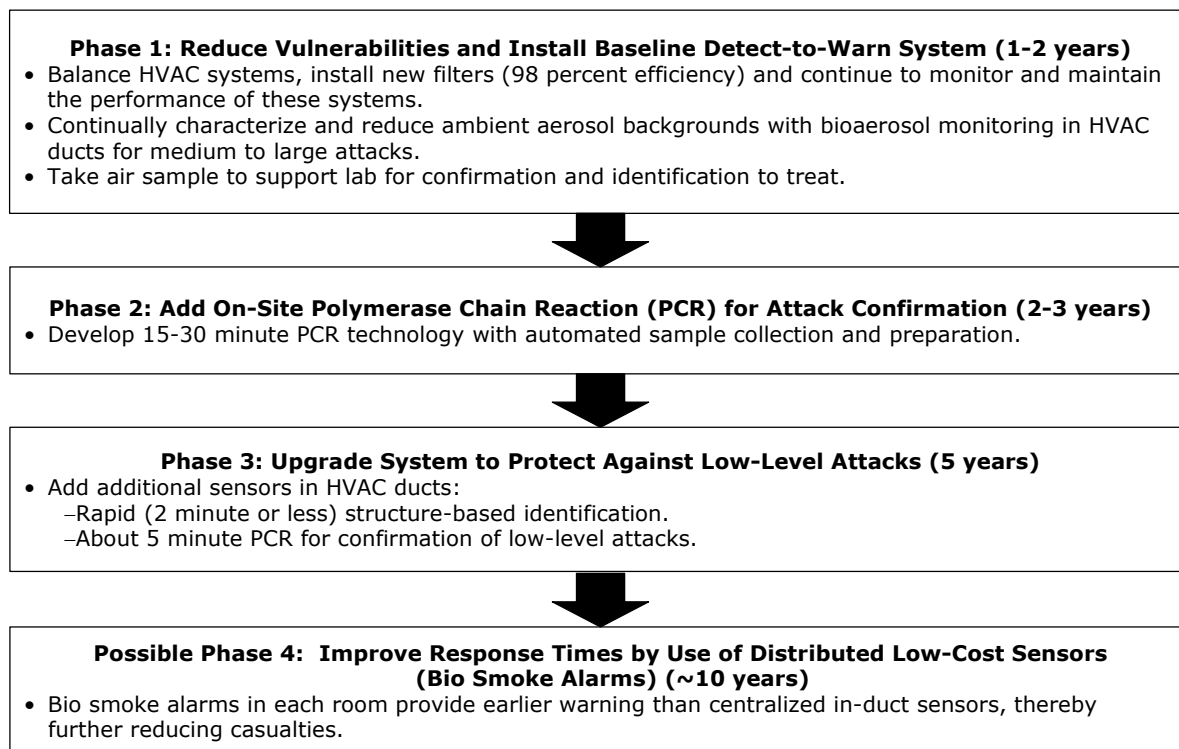

FIGURE 11.1 Suggested phased strategy for protection of high-value buildings from an aerosolized biological agent.

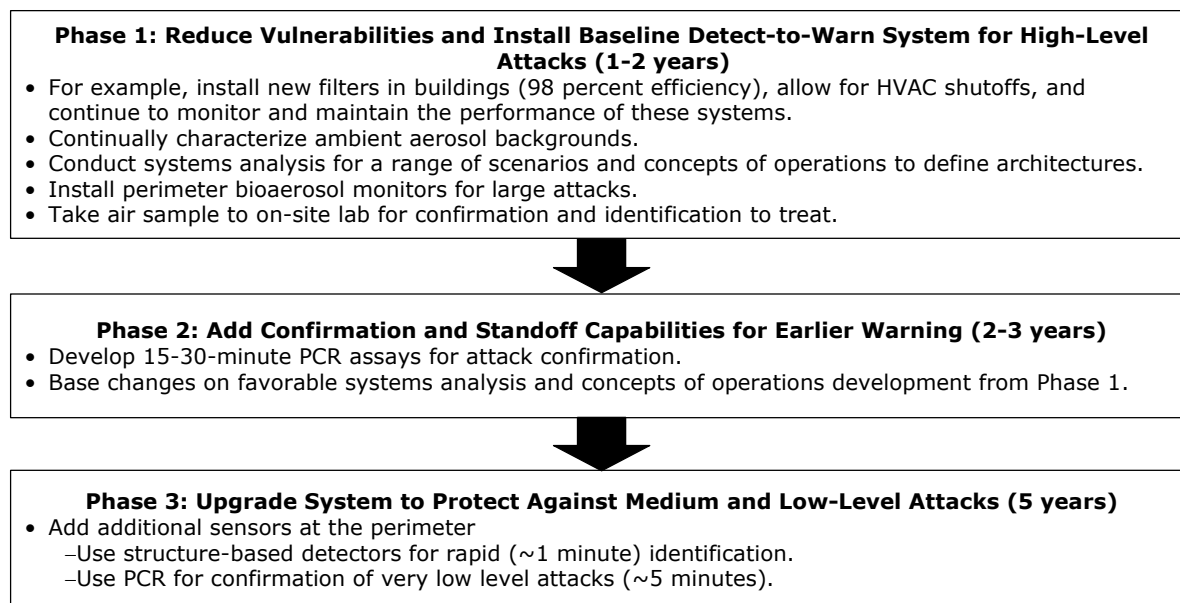

FIGURE 11.2 Suggested phased strategy for protection of extended military installations from an aerosolized biological agent.

otherwise separating out much of the data pertaining to particulates that are not threatening. As a result, robustness to variability in nonbiological particulate backgrounds is not expected to be a showstopper, although different levels of concern about these unknown environments have been expressed by members of the committee. Of potentially greater impact are possible enemy countermeasures to purposefully bypass the detection process. Although also beyond the charter of this study, an in-depth red team review of detection-based architectures is essential to address this problem.

Protection of Buildings

For building protection, the most commonly considered threat scenarios are the release of agent either inside a room or inside an open area within the facility, or release of agent directly into the exterior HVAC intake on the outside of a facility. Because of the confined spaces, even small releases can result in very high local concentrations—that is, greater than 10^5 particles per liter for a large room, or more than 10^3 particles per liter for a typical air-handling zone. These concentrations are usually well above typical ambient interior biobackgrounds (typically 1-100 particles per liter, but disturbances or movement of large numbers of people can temporarily increase levels to around 1,000 particles per liter). Hence, for these scenarios, relatively simple and rapid (about 1 minute) detection systems, e.g., bioaerosol detectors, may give a baseline facility detect-to-warn capability in the next year or two. Such a system would have the advantage of being independent of the detailed nature of the agent and hence would provide broad-spectrum coverage. Importantly, even though bioagent concentrations are high in the vicinity of the detector—making detection feasible—subsequent transport losses and filtration will reduce these concentrations by several orders of magnitude before the HVAC system circulates the contaminated air to adjacent rooms or air-handling zones.

A still more capable system would also make provisions for detecting lower-level attacks that might be used with more infectious agents, or slow-release attacks in which the perpetrator attempts to keep the bioagent concentration below the detection threshold of a simple bioaerosol detector. At these lower agent concentration levels, a bioaerosol detector would be increasingly prone to false positive or negative responses. In this case, the addition of another detector that can identify specific agents and hence

discriminate from ambient backgrounds becomes important. For example, structure-based assays currently have response times on the order of 15 minutes, but with considerable effort these times may be reduced to 1 to 2 minutes. This leads naturally to the concept of a system of detectors: a bioaerosol detector that can detect all bioagents (known and unknown) with low false alarm levels for modest to large attacks and a more sophisticated identifier that can detect the most dangerous known agents even for very small attacks—all in about 1 minute. Both the bioaerosol detector and the rapid identifier will be operating continuously, making measurements every 1 to 2 minutes. When either or both alarm at a high signal-to-noise level, high-regret responses such as sheltering in place or building evacuation will be initiated. If the detection or identification signal has a lower signal-to-noise level, then low-regret options such as HVAC shutoff or air sterilization will be initiated. In all alarm cases, an air sample will be collected and passed to a sequence-based analyzer for confirmatory analyses on the 5 to 15 minute time scale.

Because of the high cost of the associated detectors and the operational and maintenance costs associated with continuous operations, the above concept leads naturally to a centralized detection architecture in which a detection system is placed in—or samples—the HVAC system of each of the air-handling zones in a facility. The fact that the agent concentration level can be 10-100 times higher in a given room or region than in the air-handling unit also raises the intriguing possibility of a distributed detection system made up of less capable but inexpensive detectors (the biological smoke alarm concept). Additional systems analysis and research and development on such low-cost sensors are needed to better evaluate the potential of this option.

Protection of Military Installations

The most commonly postulated outdoor attack on a military base is a line release of an aerosolized agent generated by a ground vehicle or a low-flying aircraft passing upwind of the target. Placing the release path within a few kilometers of the target maximizes the concentration of the agent at the target and reduces the potential warning time for defensive measures such as donning protective masks and sheltering in place. The most obvious defensive architecture for such an attack is a perimeter detection system, i.e., a sparsely populated line of point detectors placed as far forward of the target area as possible.

As with facility protection, it seems useful to think of nonspecific detectors for warning of high-level attacks and identifiers for warning of low-level attacks. However, the agent concentration at the detector is likely to be significantly lower outdoors than in a confined building, with the actual agent concentrations dependent on whether the attack is aimed primarily at personnel who may be outdoors at the time or whether it also targets personnel inside. In addition, the variability in the concentration of background aerosols is likely to be higher outdoors than in the filtered air of a building. The net result is that the nonspecific detector will address a smaller portion of the threat space for extended installations than for buildings—for example, if its false alarm rate is low enough to support confident initiation of high-regret responses, the nonspecific detector may be able to detect only large attacks. More of the warning burden will fall on the rapid identifiers, which are about 5 years away. Fortunately, the rapid identifier need not be quite as rapid for building protection. For typical wind speeds of 5 to 10 meters per second, each kilometer of the detector's standoff distance from the actual target area results in an additional 3 minutes to take action.

In an outdoor release scenario, many of the potential agents can be treated with postexposure prophylaxis, presumably initiated by detect-to-treat systems, which can often provide effective alternatives to a detect-to-warn system. Collective protection systems can also provide safe interior zones to maintain critical functions. While the committee agrees that detect-to-treat systems will likely be the foundation of installation defense against outdoor releases in the near term, the employment of Phase 1 concepts may enable detect-to-warn capability for larger outdoor attacks and many facility attacks. This could add value in several areas, including the following:

- Even partially effective detect-to-warn systems can enable response options that might avoid or reduce exposure to organisms engineered for antibiotic resistance or to other agents (e.g., toxins) for which no prophylaxis exists.
- Initial detect-to-warn systems will provide options for that portion of the population that is contraindicated for prophylaxis.
- Some detect-to-treat warning may enable protective responses even in areas (particularly interior spaces) where more complete collective protection measures are not implemented. This could provide partial, but much less costly, defense of a much larger population.
- A nonspecific detection component will provide some capability against those agents not included in the few to tens of pathogens addressed by specific detect-to-treat assays.
- If Phase 1 is skipped, the first detect-to-warn capability will be delayed for at least 5 years until rapid identifiers become available.

Because of the above considerations, additional systems analysis is needed to better understand the cost/benefit trade-offs associated with nonspecific detection for base protection. These studies should consider both standoff and point detection and should examine a range of plausible scenarios and concepts of operations to determine the portions of the threat space that could be addressed by nonspecific detectors and what additional response options are enabled by the earlier detection that may be afforded by standoff technologies.

TOP-LEVEL TECHNICAL FINDINGS AND RECOMMENDATIONS

The phased implementation strategies suggested above reflect the committee's best judgment as to the path forward that is most likely to lead to success. However, the committee recognizes that technologies that appear less applicable today may experience breakthroughs in the future, and that totally unforeseen technologies may emerge. Thus, it has chosen to group its top-level technical findings and recommendations into two categories: the most probable path and a technology watch list. The most probable path consists of those technologies whose currently demonstrated capabilities provide the basis for a reasonably well understood path to desired detect-to-warn capabilities. The technology watch list consists of promising technologies that have yet to demonstrate one or more critical features before a clear path emerges for detect-to-warn applications.

Most Probable Path

The committee finds that protection of buildings and military installations from biological attack requires the careful integration of detection capabilities with response options and procedures. **Therefore, the committee recommends that military planners take a systems approach to facilities protection.**

The committee finds that a successful detect-to-warn system requires that the local bioaerosol background be well understood. **Therefore, the committee recommends that local aerosol backgrounds and their sources be characterized using the same methods that detectors would use.** Within buildings where detectors are to be placed, steps should be taken to reduce these backgrounds.

The committee finds that the greatest disadvantage of using rapid, nonspecific detectors such as bioaerosol detectors is their potentially high false alarm rate at very low levels of detection. **Therefore, the committee recommends that the false alarm rate of bioaerosol detectors be characterized in relevant facility environments as a function of detection threshold.** Research should be supported on additional spectral and physical signatures and improved algorithms and techniques to further decrease the false positive rates.

The committee finds that structure-based assays appear to have the greatest potential for identifying biological agents with the speed, sensitivity, and specificity required for detect-to-warn applications.

Therefore, the committee recommends that research be supported that would lead to an improved structure-based detector. The goal of this program should be a system with very low false alarm rates and a 2-minute or less overall detection time.

Although a detect-to-warn system has its highest impact if it can initiate responses within approximately 1 minute of an attack, even response times on the order of 5 to 15 minutes can be useful. The committee finds that technologies that provide confirmation of the attack and identify the organisms involved will serve a vital function in the overall defensive architecture. **Therefore, the committee recommends that research be continued on the development of an integrated, fully automated PCR system, including sample collection, preparation, and analysis.**

The committee finds that while prototype instruments for standoff detection of biological agents have been developed and tested, there is no currently fielded capability for such standoff detection, nor is there a clear concept of operations for the use of such systems. **Therefore, the committee recommends that a clear concept of operations be developed for standoff detection in support of base protection and, if appropriate, that the development of a hybrid infrared/ultraviolet laser-induced fluorescence system be expedited for these applications.**

Technology Watch List

The committee finds that mass spectrometry has the potential to identify biological agents based on a biofingerprint matching method and has the potential to do so with limited reagent consumption. **Therefore, the committee recommends that the use of laboratory mass spectrometry be investigated to better understand the performance of biofingerprinting in complex mixtures of naturally occurring microorganisms and other background contaminants.** This should be done with parallel development of improved sample preparation methods.

The committee finds that the biological smoke alarm concept offers intriguing potential for rapid detection. This concept uses networked, low-cost, semiselective detectors distributed throughout the rooms in a building. **Therefore, the committee recommends that research be conducted to develop and characterize the performance of low-cost arrays of semiselective sensors that can be used as a biological smoke alarm for triggering low-regret response measures.**

The committee finds that ribosomal RNA assays might be capable of biothreat agent identification in one to several minutes. This approach, with a major development effort, could avoid the time-consuming amplification cycles of many nucleic acid sequencing assays. **Therefore, the committee recommends that the potential and the limitations of rRNA detection for rapid identification of pathogens be explored.**

The committee finds that function-based sensors are one of the few promising candidates for detecting unknown hazardous agents—that is, agents that had not been anticipated. Their response time is inherently tied to the time it takes an agent to have a physiological effect on sentinel organisms or tissues. For certain chemical agents and toxins, this effect can be very rapid, but for bacteria and viruses, it can take much longer. These longer response times for bacteria and viruses make it unlikely that function-based sensors will play a significant role in detect-to-warn applications for these agents, but they could nevertheless play a valuable detect-to-treat role in the overall biodetection architecture. **Therefore, the committee recommends that studies be conducted to better understand the role of function-based sensors in overall biodetection architectures and to provide goals to focus research and development activities on those areas for which function-based sensors have the highest leverage.**

APPENDIXES

Appendix A

Biographical Sketches of Committee Members

John Vitko, Jr., *Chair*, has recently been named the director of Biological and Chemical Countermeasures for the newly created Department of Homeland Security. Dr. Vitko comes to that position from Sandia National Laboratories, where he has worked since receiving his Ph.D. in physics from Cornell University in 1975. Trained as a solid state physicist and spectroscopist, he has conducted basic and applied research in support of defense and energy programs; led a major portion of Sandia's Strategic Defense Programs in the 1980s; been the technical director of a multilaboratory DOE program on the use of unmanned aerospace vehicles for climate research in the 1990s; and played a formative role in many advanced detection technology programs at Sandia, ranging from lidars to a handheld suite of chromatography labs known as μ ChemLab. Since the late 1990s, Dr. Vitko has directed all of Sandia's chemical and biological defense programs and also served as coordinator for the detection thrust area of DOE's multilaboratory chemical and biological national security program and as the DOE representative to the multiagency ChemBio Detection Roadmapping Committee. In September 2002, he began working with and advising the transition planning team for the then-anticipated Department of Homeland Security, and upon creation of that department, took an assignment to direct its biological and chemical countermeasures portfolio. In that position, he and his staff are responsible for charting the vision and priorities for much of this nation's science and technology to counter and deter potential biological and chemical attacks against its population, infrastructure, and agriculture.

David R. Franz, *Vice Chair*, is chief biological scientist at the Midwest Research Institute, and serves as the director for the National Agricultural Biosecurity Center at Kansas State University and deputy director for the University of Alabama at Birmingham's Center for Disaster Preparedness. He served in the U.S. Army Medical Research and Materiel Command for 23 of his 27 years on active duty. Dr. Franz has served as both deputy commander and then commander of the U.S. Army Medical Research Institute of Infectious Diseases (USAMRIID) and as deputy commander of the U.S. Army Medical Research and Materiel Command. Prior to joining the Command, he served as group veterinarian for the 10th Special Forces Group (Airborne). Dr. Franz served as chief inspector on three United Nations special commission biological warfare inspection missions to Iraq and as technical advisor on long-term monitoring. He also served as a member of the first two U.S./U.K. teams that visited Russia in support of the Trilateral Joint Statement on Biological Weapons and as a member of the Trilateral Experts Committee for biological weapons negotiations. Dr. Franz was technical editor for the *Textbook of Military Medicine: Medical Aspects of Chemical and Biological Warfare*, released in 1997. His current national-level committee appointments include the Defense Intelligence Agency Red Team Bio-Chem 2020; the Department of

Homeland Security Science and Technology Advisory Board; the Defense Threat Reduction Agency Threat Reduction Advisory Committee, Science and Technology Panel; the National Academy of Sciences (NAS) Committee on the Control of Genomic Information; and the NAS Committee for Research with Russian Biological Institutes, which he chairs. He holds a D.V.M. from Kansas State University and a Ph.D. in physiology from Baylor College of Medicine.

Mark Alper received his A.B. degree with honors from Harvard College and his Ph.D. in biochemistry from the University of California at Berkeley. He is deputy division director, Materials Sciences Division, Lawrence Berkeley National Laboratory (LBNL); director, Biomolecular Materials Program, LBNL; and adjunct professor, Department of Molecular and Cell Biology, University of California at Berkeley. Dr. Alper provides expertise in biochemistry and molecular biology. He is conducting research on various biosensor technologies, including a colorimetric biosensor and a magnetic biosensor based on a superconducting quantum interference device (SQUID). He has held a number of other research management positions, including executive director, Chancellor's Biotechnology Council (University of California at Berkeley), and deputy director, Center for Advanced Materials (LBNL). Professor Alper founded the LBNL biomolecular materials program and has been director since its inception. In addition, he has most recently been chair, DOE Office of Fossil Energy, LBNL molecular foundry workshop on nanoscience and nanotechnology; co-chair, DOE Workshop on Impact of Biology on the Physical Sciences; member, Chancellor's Materials Council, University of California at Berkeley; symposium co-chair, Materials Research Society; co-organizer, DOE Office of Science Workshop on Complex and Collective Phenomena; editor, *Report of the Workshop on Complex and Collective Phenomena*, U.S. Department of Energy, Office of Science; and participant, DOE Nanoscience/Nanotechnology Working Group. He was also a panel member on an NRC study examining materials research for 21st century defense needs.

Peter D.E. Biggins is currently the head of international research at Dstl, Chemical and Biological Sciences. Prior to that he was the technical manager for all aspects of research on biological and chemical detection, including data fusion. He has led teams working on operational analysis issues and the application of knowledge-based systems. He worked for the British Cast Iron Research Association on providing technical solutions for reducing air pollution arising from processes used in the iron and steel industry in both the workplace and the external environment. Dr. Biggins holds a B.Sc. (Hons) in biological sciences from London University, a M.Phil. in chemistry from the University of Aston in Birmingham, and a Ph.D. in atmospheric chemistry from Lancaster University.

Larry D. Brandt is manager of the Systems Research Department at Sandia National Laboratories in Livermore, California. In that position, he oversees studies and computer modeling projects dealing with topics that include chemical and biological defense systems, nuclear weapons stockpile stewardship, infrastructure safety and reliability, strategic defense threat characterization, and Laboratory program guidance. He also leads Sandia participation in the PROTECT Domestic Demonstration and Application Program, one of the two principal demonstration programs within the DOE chemical and biological national security program. During his 30-year career at Sandia, Dr. Brandt has conducted or led systems analysis and program definition efforts addressing a wide range of topics, including design and effectiveness of the nuclear stockpile, strategic missile defense threat and architectures, and Laboratory strategic planning. In a 1987-1989 Washington, D.C., assignment, he established and led enduring systems threat development programs for the Strategic Defense Initiative Office (Phase One Engineering Team). During the 1993-1994 academic year, he conducted research in technologies and policies to counter WMD proliferation as a Carnegie Foundation Science Fellow at the Center for International Security and Cooperation at Stanford University. Dr. Brandt holds M.S.E.E. and Ph.D. degrees from Stanford University.

Cindy Bruckner-Lea is a staff scientist at Pacific Northwest National Laboratory (PNNL). She received her bachelor's degree in chemical engineering from the University of California at Davis in 1985 and a Ph.D. in bioengineering from the University of Utah in 1990. While a graduate student at the University of

Utah, she developed new methods for interfacing phospholipid bilayers with electrochemical sensors for biodetection. During the past 10 years at PNNL, she developed a microfluidic biosensor research program that has resulted in the development of renewable surface separation and sensing approaches for optically monitoring bacterial cells, studying DNA-protein interactions, automating the separation of protein complexes for mass spectrometry, and extracting and detecting DNA in environmental samples. Dr. Bruckner-Lea is currently serving as chair of the Sensor Division of the Electrochemical Society.

Harriet A. Burge was educated at San Francisco State University and the University of Michigan. She spent 25 years in the Allergy Division, Department of Internal Medicine, at the University of Michigan Medical School as a research scientist studying environmental aspects of allergic disease, especially with respect to fungal aerosols. After retiring as emeritus research scientist from that institution, she moved to the Harvard School of Public Health and has, over the past 10 years, developed a strong and unique program in aerobiology. Her research interests have continued to focus on allergy and asthma, especially in children, and she directs the exposure assessment parts of three large epidemiological studies evaluating causes for the increased incidence of acute asthma in children. A second large focus for Dr. Burge's research is in basic aerobiology, especially the study of survivability in aerosols of infectious disease agents, and the development of risk models to predict the efficacy of exposure control approaches.

Richard Ediger is director of new technology for PerkinElmer Analytical Instruments, where he has been employed for 28 years in technical and managerial positions. In his role as the primary internal guidepost for emerging measurement technologies, he has a long association with national laboratory initiatives in the chemical and biological weapons detection area. His position with PerkinElmer provides a perspective on some of the challenges of bringing promising detection systems into routine availability in a short time frame. For much of his career, he has been involved in a series of new technology assessment programs, utilizing chemical sensors for the past 8 years. His technical activities prior to that time were oriented to atomic spectroscopy. He is knowledgeable in sensor technologies such as surface acoustic wave sensors, microscale electrochemical devices for both vapor-phase and liquid compounds, integrated lab-on-a-chip systems, vapor preconcentrators for chip-based gas chromatography, DNA chips, and microscale high-performance liquid chromatography. He also has familiarity with mass spectrometry technologies used for vapor- and solution-phase sensing. Because many of his recent activities have related to the transfer of national laboratory technologies for the detection of chemical and biological warfare agents to the commercial marketplace, he is familiar with many of the candidate technologies and with their projected applicability to national security issues.

Mark A. Hollis received the B.S.E. degree with honors in electrical engineering from Duke University in 1979. He then entered graduate study in electrical engineering at Cornell University, where he received the M.S. degree in 1981 and the Ph.D. degree in 1983. His doctoral thesis work was on the fabrication and characterization of GaAs planar-doped barrier transistors. In 1978 and 1979 he was employed by the Health Effects Research Laboratory of the U.S. Environmental Protection Agency, where he was involved in research on the biological effects of microwave radiation. While there, he designed and constructed an RF spectrometer for the measurement of the dielectric relaxation of biological molecules in aqueous solution. In 1983, he joined MIT's Lincoln Laboratory in Lexington, Massachusetts, where he became engaged in the development of permeable base transistors and related vertical majority-carrier devices. He is now leader of the Biosensor and Molecular Technologies Group at Lincoln Laboratory as well as a research affiliate in MIT's Research Laboratory of Electronics (RLE). At RLE, Dr. Hollis and his colleagues pioneered microelectronic devices called genosensors, which can determine the sequence of bases in DNA molecules placed directly on the microelectronic circuits. Dr. Hollis served in the past as an associate editor for the IEEE's *Electron Device Letters* and was responsible for the areas of field-effect transistors, quantum devices, and vacuum microelectronics. He served as chairman of the 1993 International Vacuum Microelectronics Conference in July 1993 and was also a member of the Instrumentation Advisory Committee for the Center for Genome Research at the Whitehead Institute in

Cambridge, Massachusetts. He has published over 50 technical papers in engineering and biology and holds eight patents with several others pending. Some of these patents are in the area of DNA-chip technology, where he and his colleagues invented some of the basic concepts in this field.

Leo L. Laughlin is a senior research scientist with Battelle. He holds a Ph.D. in chemistry from the University of New Hampshire, an M.S. in chemistry from Drexel University, and a B.S. in biology from Georgetown University. He has an unusually varied and extensive background with over 40 years' experience in all aspects of chemical and biological warfare, including defensive policy and doctrine development, chemical and biological agent and weapons threat evaluation, weapons testing, operational testing and evaluation of defense material, and research on the physiological and pharmacological effects of chemical warfare agents and therapeutic drugs. Dr. Laughlin has managed several other studies for the federal government in nuclear, biological, and chemical weapons.

Raymond P. Mariella, Jr., received his B.A. from Rice University in Houston, Texas, where he graduated magna cum laude with a triple major in mathematics, chemistry, and chemical engineering. His undergraduate research advisor was R.F. Curl, Jr. He received his A.M. and Ph.D. in physical chemistry from Harvard University. His thesis advisors were Dudley Herschbach and William Klemperer. He taught physical chemistry at Harvard University for 1 year, was a visiting scientist in the physics department at MIT for 2 years with Ali Javan, and was a research fellow at the IBM research laboratory in San Jose for 1 year. He spent 10 years at the Allied-Signal Corporate Research Center before joining Lawrence Livermore National Laboratory, where he has been for the past 14 years. He currently serves LLNL as the director of its Center for Microtechnology.

Andrew R. McFarland is a professor of mechanical engineering at Texas A&M University, where he teaches courses in thermodynamics, fluid mechanics, and aerosol mechanics and conducts research in the general area of aerosol mechanics. He is a graduate of the University of Minnesota and has held faculty positions at that institution, at the University of Notre Dame, and at the University of Illinois. For several summers during the 1990s, he worked at Los Alamos National Laboratory, where he and a collaborator from the laboratory developed methodology for single-point representative sampling of radionuclides from stacks and ducts of the nuclear industry. Under funding for the Army, his research group (the Aerosol Technology Laboratory, ATL) is developing methodologies for sampling, transporting, and collecting bioaerosols. Under funding from DOE facilities and the U.S. Nuclear Regulatory Commission, ATL has developed shrouded probe nozzles for collecting representative samples on a continuous basis. Software has been developed for predicting the effectiveness of air sampling systems. His current effort under funding from DOE sources is primarily directed at modeling the mixing of contaminants and bulk flows in order to create conditions suitable for application of single-point, representative sampling and at modeling aerosol losses in components of transport systems.

R. Paul Schaudies is a nationally recognized expert in the fields of biological and chemical warfare defense. He has served on numerous national level advisory panels for the Defense Intelligence Agency, the Defense Advanced Research Projects Agency, and the Department of Energy. He has 14 years of bench research experience managing laboratories at Walter Reed, Walter Reed Army Institute of Research, and as a visiting scientist at the National Cancer Institute. He served for 13 years on active duty with the Army Medical Service Corps and separated from service at the rank of lieutenant colonel-select. Dr. Schaudies spent 4 years with the Defense Intelligence Agency as collections manager for biological and chemical defense technologies. As such, he initiated numerous intra-agency collaborations that resulted in accelerated product development in the area of biological warfare agent detection and identification. Dr. Schaudies is currently an assistant vice president and division manager of the Biological and Chemical Defense Division at SAIC. His division focuses in three major business areas: contract biomedical research, technology assessments, and scientific studies. Since joining SAIC, Dr. Schaudies has served on or chaired numerous technology review and advisory panels for U.S.

government agencies. Dr. Schaudies received his bachelor's degree in chemistry from Wake Forest University and his doctoral degree from Temple University School of Medicine in the Department of Biochemistry. He has authored 27 scientific manuscripts in the peer-reviewed literature, as well as three book chapters. Dr. Schaudies is active in both government and academic circles.

Appendix B

Acronyms and Abbreviations

ACPLA	agent-containing particles per liter of air
ACTD	Advanced Concept Technology Demonstration
AD	aerodynamic diameter
ADP	adenosine diphosphate
AHTS	aerosol-to-hydrosol transfer stage
AIDS	acquired immune deficiency syndrome
AK	adenylate kinase
AMV	alfalfa mosaic virus
ANSI	American National Standards Institute
A/SPODs	airports and seaports of debarkation
ATP	adenosine triphosphate
BASIS	Biological Aerosol Sentry and Information System
BAWS	biological agent warning sensor
bDNA	branched DNA
BIDS	Biological Integrated Detection System
BW	biowarfare
CANARY	cellular analysis and notification of antigen risks and yields
CBIAC	Chemical and Biological Information Analysis Center
CBMS	chemical-biological mass spectrometer
CDC	Centers for Disease Control and Prevention
cDNA	complementary DNA
cfu	colony-forming unit
CO ₂	carbon dioxide
CSA	catalyzed signal amplification
DARPA	Defense Advanced Research Projects Agency
DNA	deoxyribonucleic acid
DoD	U.S. Department of Defense
DOE	U.S. Department of Energy
Dstl	Defense Science and Technology Laboratory (U.K.)
DTRA	Defense Threat Reduction Agency
DTW	detect-to-warn

ECBC	Edgewood Chem-Bio Center
ELISA	enzyme-linked immunosorbent assay
EPA	Environmental Protection Agency
FLAPS	fluorescent aerodynamic particle sizing
FTIR	Fourier transform infrared
HEPA	high-efficiency particulate air
HHA	handheld immunochromatographic assay
HIV	human immunodeficiency virus
HVAC	heating, ventilation, and air conditioning
ID	identification
IOM	Institute of Medicine
IR	infrared
ISE	ion-selective electrodes
JBPDS	Joint Biological Point Detection System
JBREWS	Joint Biological Remote Warning System
LAR	ligase amplification reaction
LBNL	Lawrence Berkeley National Laboratory
LCR	ligase chain reaction
LD ₅₀	lethal dose 50 (having a 50 percent probability of causing death)
lidar	light detection and ranging
LSPR	localized surface plasmon resonance
MALDI	matrix-assisted laser desorption/ionization
MIT	Massachusetts Institute of Technology
MRE	molecular recognition element
mRNA	messenger RNA
MS	mass spectrometer
MS/MS	tandem mass spectrometry
NAD(P)	nicotinamide adenine dinucleotide (phosphate)
NAD(P)H	reduced nicotinamide adenine dinucleotide (phosphate)
NADH	reduced nicotinamide adenine dinucleotide
NASBA	nucleic acid-sequence-based amplification
NIJ	National Institute of Justice
NIOSH	National Institute for Occupational Safety and Health
NRC	National Research Council
OTA	Office of Technology Assessment
PCR	polymerase chain reaction
pH	potential of hydrogen; negative 10-base log (power) of the positive hydrogen ion concentration; measure of acidity
pI	isoelectric point; the pH at which a particle is neutral
PM-10	particulate matter of 10 micrometers in diameter or smaller
QCM	quartz crystal microbalance
Q β	RNA bacteriophage
RCA	rolling circle amplification
RNA	ribonucleic acid
rRNA	ribosomal RNA

SAW	surface acoustic wave
SDA	strand displacement amplification
SMART	sensitive membrane antigen rapid test
SPR	surface plasmon resonance
TOF	time of flight
tRNA	transfer RNA
TSM	thickness shear mode
UK NAIAD	United Kingdom National Institutes of Allergy and Infections
USNRC	United States Nuclear Regulatory Commission
UV	ultraviolet
UV-LIF	ultraviolet laser-induced fluorescence
UVRR	UV resonance Raman